

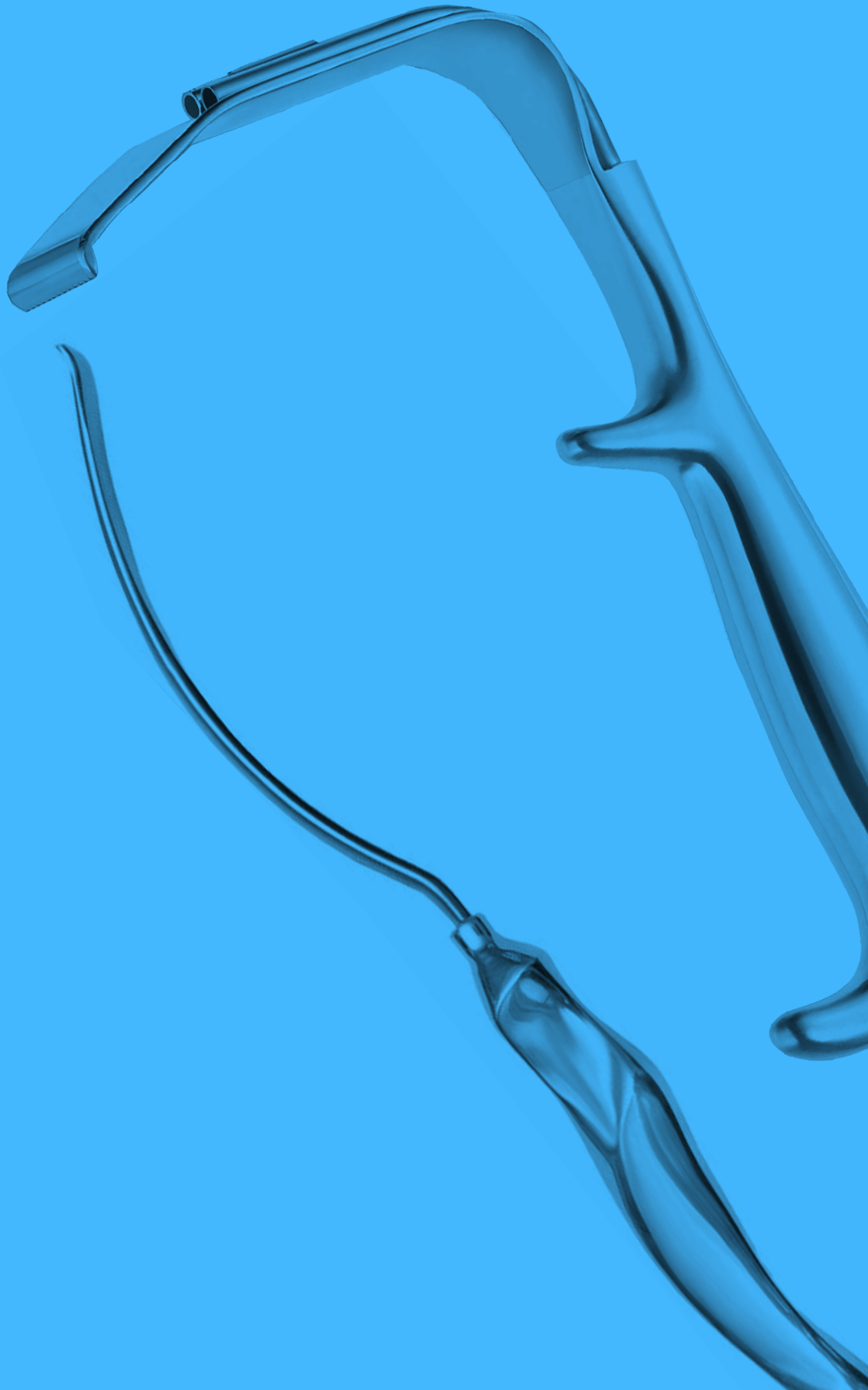

PLASTIC SURGERY CATALOGUE

2025



WE

ZULFIQAR SURGICAL is known for its quality For Surgical instruments and Instruments for surgery and is an operated business that has been dedicated to providing healthcare professionals with the products they need to perform their art since a long. Our high quality, precision crafted instruments have been an essential product line to our worthy customers. We carry an exclusive range of Surgical Instruments, Surgical Instruments and Healthcare Equipments.

We are committed to providing a product line that guarantees quality and extraordinary value to the end user as well as a level of service, satisfaction, and cooperation that has become a hallmark of Eco Surgical. We have gained a reputation for offering unbeatable prices on branded items as well as outstanding customer service on all levels. Every single instrument is manufactured with great care. We are working hard for maintaining higher standard. Advanced techniques are used in manufacturing and finishing departments in order to made best products.

ZULFIQAR SURGICAL is offering you huge selection of our products and much more for a fast growing number of customers. We make it easy for you to browse our products, place orders and benefit from our quality services.

We assure you quality instruments, most competitive prices and shortest delivery time.

All Instruments are available in a high-polish or satin/matte finish according to individual preferences. Constructed from high-quality 300, 410, or 420 Series Stainless Steel, these devices meet or exceed all ASTM/AISI International Standards for Medical Device production. Undergoing the latest finishing techniques to prevent rusting and future corrosion, our state-of-the-art method includes, but is not limited to: surface grinding, broaching, heat treating, drilling, tapping, electronically passivating and I.D./O.D. Threading.

Scissors	01-12
Needle Holders	13-20
Forceps / Thumb	21-26
Nasal Rasps	27-29
Fiber Optic Retractors	30-32
Retractors	33-41
Breast Retractors	42
Augmentation (TUBA) Set	43
Shaper	44-46
Osteotomes	47-48
Mallets	49
Morselizers	50
Saws	51
Nasal Speculas	52
Elevators	53-54
Hooks	55-56
Measuring	57
Dissectors	58
Markers	59-60
Forceps	61-63
Knives	64-65
Rongeurs	66
Bone Cutting Forceps	67
Miscellaneous	68-69
Iconoclasts	70
Cannulas / Lipo Suction	71-72



INDEX

ZS-21518
ZS-21420
ZS-21520
ZS-21523

Gorney
18.0 cm, curved, serrated, TC
20.0 cm, straight, serrated, TC
20.0 cm, curved, serrated, TC
23.0 cm, curved, serrated, TC



ZS-21220
ZS-21320

Gorney
20.0 cm, straight, serrated
20.0 cm, curved, serrated



ZS-21620
ZS-21720

Freeman Gorney
20.0 cm, straight, TC
20.0 cm, curved, TC

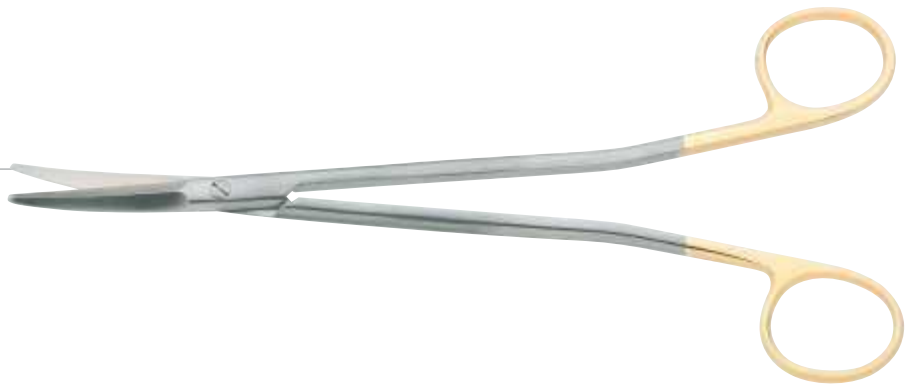

ZS-21918
ZS-22018

Freeman
18.0 cm, straight, TC
18.0 cm, curved, TC



Aston-Face
ZS-24516 17.0 cm, curved
ZS-24520 20.0 cm, curved



Rees
ZS-22417 17.0 cm, straight, serrated, TC
ZS-22517 17.0 cm, curved, serrated, TC
ZS-22419 20.0 cm, straight, serrated, TC
ZS-22519 20.0 cm, curved, serrated, TC



Kaye
ZS-23315 15.0 cm, curved, serrated, TC
ZS-23323 23.0 cm, curved, serrated, TC



Kaye
ZS-23312 11.5 cm, curved, serrated, TC



ZS-21818
ZS-21820

Freeman (Kaye)
18.0 cm, curved, serrated, TC
20.0 cm, curved, serrated, TC



ZS-24018

Davis
18.0 cm, curved,
serrated, sharp/sharp, TC



ZS-24816

Castanares
16.5 cm, straight, TC



ZS-82313

Goldman Fox
13.0 cm, curved, serrated, TC



Par Style
very delicate
ZS-20911 11.5 cm, curved, TC
ZS-20914 14.5 cm, curved, TC
for serrated blades please add "WS"



Stevens Tenotomy
ZS-36051 11.5 cm, straight, TC
ZS-36151 11.5 cm, curved, TC



Stevens Tenotomy
ZS-36011 11.0 cm, straight, sharp/sharp
ZS-36111 11.0 cm, curved, sharp/sharp
ZS-36211 11.0 cm, straight, blunt/blunt
ZS-36311 11.0 cm, curved, blunt/blunt



Devine
fine dissecting scissors
with sharp tips,
ZS-21011 11.0 cm, curved, TC



ZS-31212
ZS-31412
ZS-5851

Kilner
12.0 cm, straight, TC
12.0 cm, curved, TC
12.0 cm, curved 1
blade TC
1 blade serrated



ZS-37411
ZS-37511
ZS-37411
ZS-37511

Strabismus
11.0 cm, straight, TC
11.0 cm, curved, TC
11.0 cm, straight, supercut
11.0 cm, curved, supercut
for serrated blades please add "WS"



ZS-34211
ZS-34311
ZS-34251
ZS-34351

Iris
11.5 cm, round, straight, sharp/sharp
11.5 cm, round, curved, sharp/sharp
11.5 cm, round, straight, sharp/sharp, TC
11.5 cm, round, curved, sharp/sharp, TC
for serrated blades please add "WS"



ZS-34011
ZS-34111
ZS-34411
ZS-34511

Iris
11.5 cm, square, straight, sharp/sharp
11.5 cm, square, curved, sharp/sharp
11.5 cm, square, straight, sharp/sharp, TC
11.5 cm, square, curved, sharp/sharp, TC
for serrated blades please add "WS"



Joseph
ZS-30414 14.0 cm, straight, sharp/sharp
ZS-30514 14.0 cm, curved, sharp/sharp
ZS-30454 14.0 cm, straight, sharp/sharp, TC
ZS-30554 14.0 cm, curved, sharp/sharp, TC



Locklin
ZS-53916 16.0 cm, straight,
angled, sharp/sharp, TC



Shea
ZS-30612 12.0 cm, sharp, fine, curved



Wilmer Converse
ZS-35010 10.5 cm, angled up



ZS-40118 **Heymann**
18.0 cm, angled to side



ZS-39518 **Knight**
18.0 cm, angled to side, serrated,
delicate blades, TC



ZS-40354 **Fomon**
14.5 cm, angled, TC



ZS-40716 **Cottle**
17.0 cm, angled, TC



Metzenbaum Fino blunt/blunt

ZS-28615	14.5 cm, straight, TC
ZS-28715	14.5 cm, curved, TC
ZS-28618	18.0 cm, straight, TC
ZS-28718	18.0 cm, curved, TC
ZS-28620	20.0 cm, straight, TC
ZS-28720	20.0 cm, curved, TC
ZS-28623	23.0 cm, straight, TC
ZS-28723	23.0 cm, curved, TC
ZS-28628	28.0 cm, straight, TC
ZS-28728	28.0 cm, curved, TC

for serrated blades please add "WS"



Metzenbaum sharp/sharp

ZS-27415	14.5 cm, straight, TC
ZS-27515	14.5 cm, curved, TC
ZS-27418	18.0 cm, straight, TC
ZS-27518	18.0 cm, curved, TC
ZS-27423	23.0 cm, straight, TC
ZS-27523	23.0 cm, curved, TC

for serrated blades please add "WS"



Metzenbaum blunt/blunt

ZS-28415	14.5 cm, straight, TC
ZS-28515	14.5 cm, curved, TC
ZS-28418	18.0 cm, straight, TC
ZS-28518	18.0 cm, curved, TC
ZS-28420	20.5 cm, straight, TC
ZS-28520	20.5 cm, curved, TC
ZS-28423	23.0 cm, straight, TC
ZS-28523	23.0 cm, curved, TC
ZS-28428	28.0 cm, straight, TC
ZS-28528	28.0 cm, curved, TC

for serrated blades please add "WS"



Metzenbaum, blunt/blunt

ZS-28015	14.5 cm, straight, supercut
ZS-28115	14.5 cm, curved, supercut
ZS-28018	18.0 cm, straight, supercut
ZS-28118	18.0 cm, curved, supercut
ZS-28023	23.0 cm, straight, supercut
ZS-28123	23.0 cm, curved, supercut



ZS-17415
ZS-17515
ZS-17417
ZS-17517

Mayo-Stille
15.0 cm, straight, TC
15.0 cm, curved, TC
17.0 cm, straight, TC
17.0 cm, curved, TC

for serrated blades please add "WS"



ZS-17017
ZS-17117

Mayo-Stille
17.0 cm, straight, supercut
17.0 cm, curved, supercut



ZS-19421
ZS-19521

Mayo-Lexer
21.0 cm, straight, TC
21.0 cm, curved, TC



ZS-11214
ZS-11314

Operating sharp/blunt
14.5 cm, straight, round, TC
14.5 cm, curved, round, TC



Operating sharp/sharp
14.5 cm, straight, round, TC
14.5 cm, curved, round, TC

ZS-12214
ZS-12314



Operating blunt/blunt
14.5 cm, straight, round, TC
14.5 cm, curved, round, TC

ZS-10614
ZS-10714



Littler
12.0 cm, curved, tips with eye for suture
14.0 cm, curved, tips with eye for suture

ZS-20512
ZS-20514



Fomon
13.5 cm, lower lateral scissor,
strongly curved

ZS-40213



ZS-83512 **Universal Wire Scissors**
12.0 cm, serrated, TC

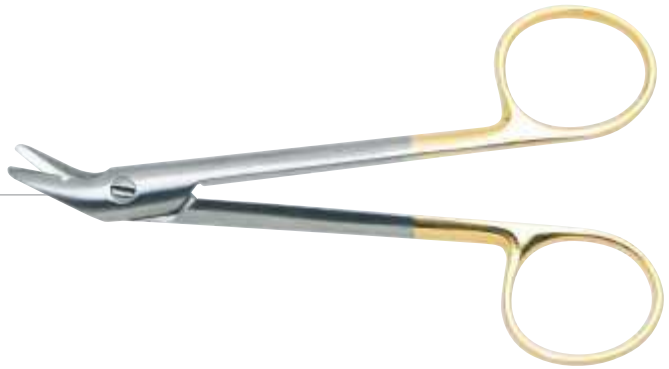

ZS-26120 **Caplan Septum**
22.0 cm, one blade serrated,
double action, straight

ZS-26122 22.0 cm, one blade serrated,
double action, curved



ZS-90114 **Lister Bandage**
14.0 cm, angled

ZS-90118 18.0 cm, angled



ZS-21617 **Freeman Kaye**
17.0 cm, curved



Stevens Tenotomy Scissors

- ZS-36509** 9.5 cm, curved, sharp/sharp, ribbon type
- ZS-36512** 12.0 cm, curved, sharp/sharp, ribbon type



Iris

- ZS-32209** 9.5 cm, straight, sharp/sharp, ribbon type
- ZS-32309** 9.5 cm, curved, sharp/sharp, ribbon type
- ZS-32610** 10.5 cm, straight, sharp/sharp, ribbon type
- ZS-32710** 10.5 cm, curved, sharp/sharp, ribbon type



Spencer

- ZS-80209** 9.0 cm, straight, ligature scissor



Knowles Bandage

- ZS-93114** 14.0 cm, angled, serrated



Micro Scissors

spring scissors with round handle, blade 14 mm

- ZS-20615** 15.0 cm, straight
- ZS-20815** 15.0 cm, straight, blades serrated
- ZS-20715** 15.0 cm, curved
- ZS-20915** 15.0 cm, curved, blades serrated
- ZS-20618** 18.0 cm, straight
- ZS-20818** 18.0 cm, straight, blades serrated
- ZS-20718** 18.0 cm, curved
- ZS-20918** 18.0 cm, curved, blades serrated



Webster
11.5 cm, smooth
13.0 cm, smooth, TC

ZS-12811
ZS-12913

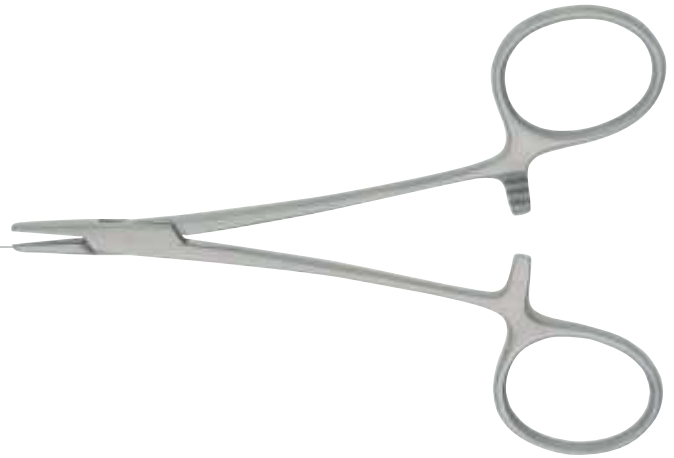

Halsey
13.0 cm, smooth, TC
13.0 cm, cross serrated, TC

ZS-13413
ZS-14413

Par
11.5 cm, cross serrated, TC
13.0 cm, cross serrated, TC

ZS-14011
ZS-14013



Derf
12.0 cm, serrated
12.0 cm, cross serrated, TC

ZS-11012
ZS-11412

ZS-14713 **Neivert**
13.0 cm, cross serrated, TC

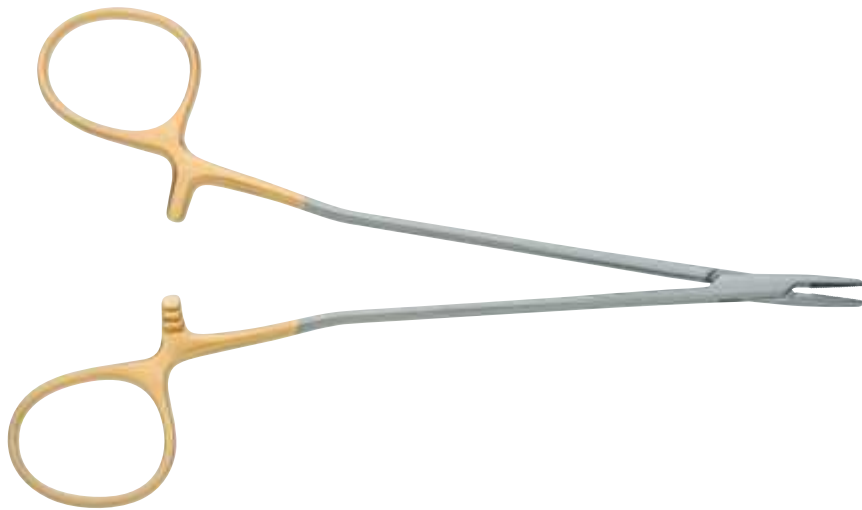

Swedish
15.5 cm, cross serrated, TC **ZS-21815**

ZS-22413 **Ryder**
13.0 cm, cross serrated, TC
ZS-22415 15.0 cm, cross serrated, TC
ZS-22418 18.0 cm, cross serrated, TC



Micro Ryder
13.0 cm, cross serrated, TC **ZS-22613**
15.0 cm, cross serrated, TC **ZS-22615**
18.0 cm, cross serrated, TC **ZS-22618**

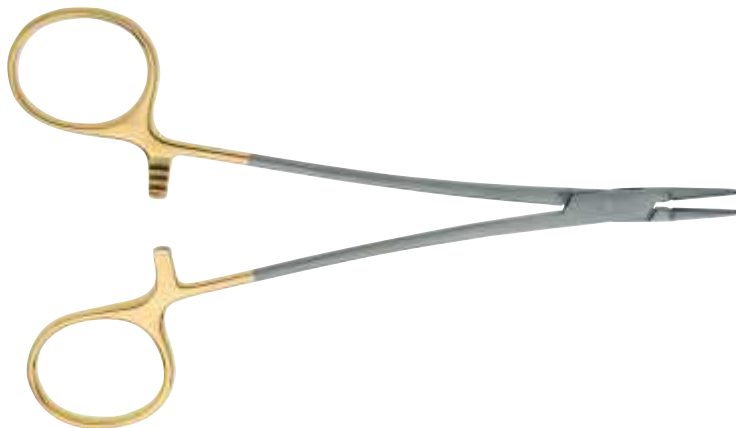

Euphrate-Pasque
extremely delicate

- ZS-23814 14.0 cm, cross serrated, TC
- ZS-23815 15.0 cm, cross serrated, TC
- ZS-23818 18.0 cm, cross serrated, TC
- ZS-23820 20.0 cm, cross serrated, TC

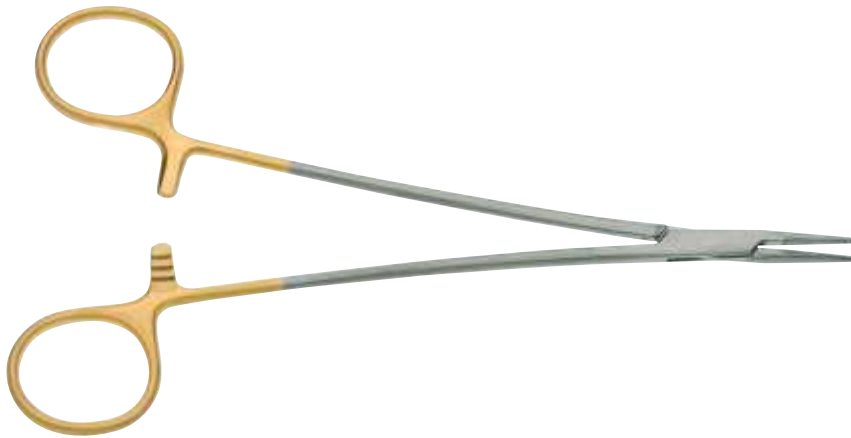
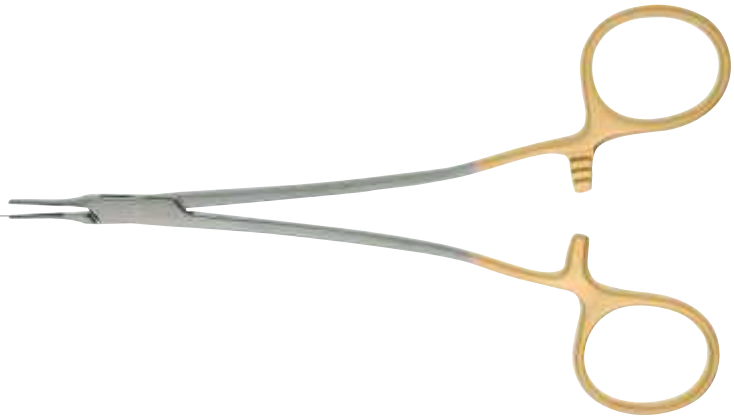

Micro-Vascular

- 15.0 cm, cross serrated, TC **ZS-23415**
- 18.0 cm, cross serrated, TC **ZS-23418**

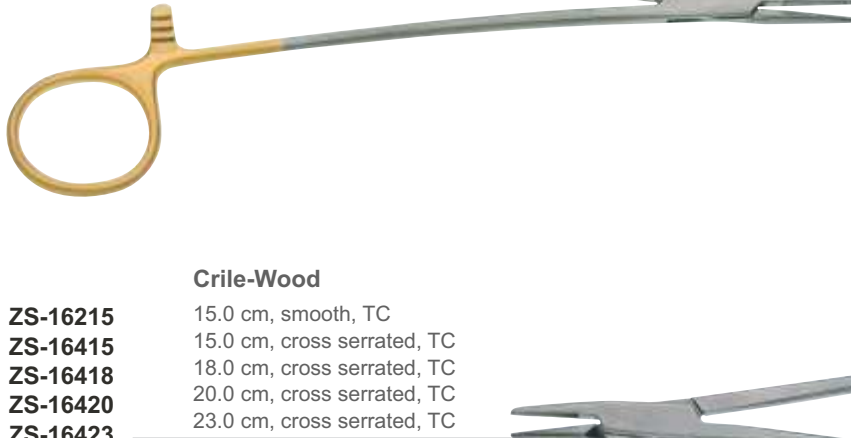

Crile-Wood

- ZS-16215 15.0 cm, smooth, TC
- ZS-16415 15.0 cm, cross serrated, TC
- ZS-16418 18.0 cm, cross serrated, TC
- ZS-16420 20.0 cm, cross serrated, TC
- ZS-16423 23.0 cm, cross serrated, TC

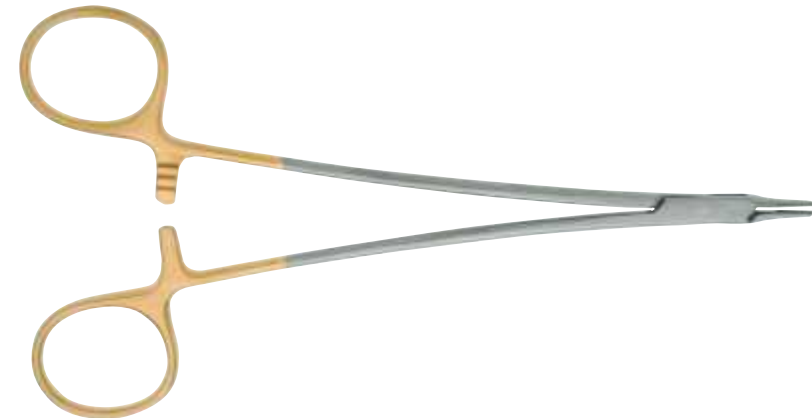
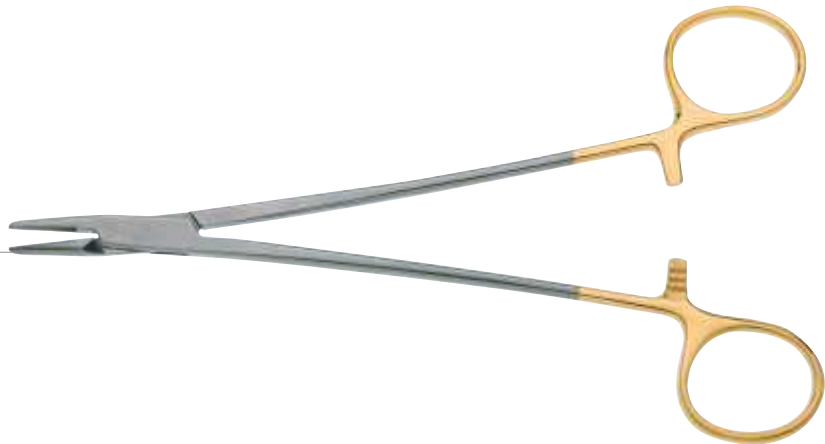

Lemmon

- 14.0 cm, cross serrated, TC **ZS-24814**
- 17.0 cm, cross serrated, TC **ZS-24817**
- 19.0 cm, cross serrated, TC **ZS-24819**

Baumgartner

ZS-15412
ZS-15414

12.5 cm, cross serrated, TC
14.0 cm, cross serrated, TC



Mayo Hegar



14.0 cm, cross serrated, TC **ZS-18414**
16.0 cm, cross serrated, TC **ZS-18416**
18.0 cm, cross serrated, TC **ZS-18418**
20.0 cm, cross serrated, TC **ZS-18420**

Wire Twister

ZS-60011
ZS-60001
ZS-60012
ZS-60002

13.0 cm, round jaw, cross serrated, TC
16.0 cm, blunt jaw, cross serrated, TC
18.0 cm, round jaw, cross serrated, TC
18.0 cm, blunt jaw, cross serrated, TC

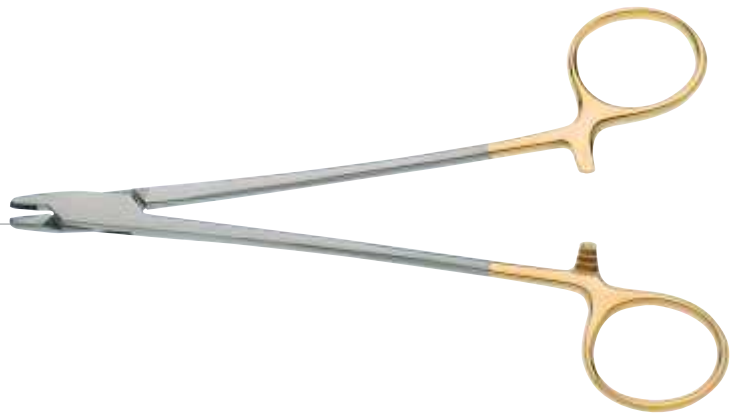

Corwin Wire Twister



16.0 cm, long round jaw, cross serrated, TC **ZS-53901**
16.0 cm, blunt jaw, cross serrated, TC **ZS-53902**
16.0 cm, round jaw, cross serrated, TC **ZS-53903**

Olsen Hegar
needleholder/scissors combination
ZS-41414 14.0 cm, cross serrated, TC
ZS-41418 18.0 cm, cross serrated, TC



Gillies
needleholder/scissors combination
ZS-43416 16.0 cm, cross serrated, curved, TC



Barraquer Micro

with round handle, without lock, tip 0.8 × 1.2 mm

- ZS-64014** 14.0 cm,
straight, diamond dusted
- ZS-64114** 14.0 cm,
curved, diamond dusted
- ZS-64015** 15.0 cm,
straight, diamond dusted
- ZS-64115** 15.0 cm,
curved, diamond dusted
- ZS-64018** 18.0 cm,
straight, diamond dusted
- ZS-64118** 18.0 cm,
curved, diamond dusted



Barraquer Micro

with round handle, with lock, tip 0.8 × 1.2 mm

- ZS-64214** 14.0 cm,
straight, diamond dusted
- ZS-64314** 14.0 cm,
curved, diamond dusted
- ZS-64215** 15.0 cm,
straight, diamond dusted
- ZS-64315** 15.0 cm,
curved, diamond dusted
- ZS-64218** 18.0 cm,
straight, diamond dusted
- ZS-64318** 18.0 cm,
curved, diamond dusted



Barraquer Delicate

with round handle, without lock, tip 1.2 × 1.8 mm

- ZS-63414** 14.0 cm,
cross serrated, straight, TC
- ZS-63514** 14.0 cm,
cross serrated, curved, TC
- ZS-63415** 15.0 cm,
cross serrated, straight, TC
- ZS-63515** 15.0 cm,
cross serrated, curved, TC
- ZS-63418** 18.0 cm,
cross serrated, straight, TC
- ZS-63518** 18.0 cm,
cross serrated, curved, TC



Barraquer Micro

with round handle, without lock, tip 0.8 × 1.2 mm

- ZS-63614 14.0 cm, cross serrated, straight, TC
- ZS-63714 14.0 cm, cross serrated, curved, TC
- ZS-63615 15.0 cm, cross serrated, straight, TC
- ZS-63715 15.0 cm, cross serrated, curved, TC
- ZS-63618 18.0 cm, cross serrated, straight, TC
- ZS-63718 18.0 cm, cross serrated, curved, TC



Barraquer Delicate

with round handle, with lock, tip 1.2 × 1.8 mm

- ZS-66714 14.0 cm, cross serrated, straight, TC
- ZS-66614 14.0 cm, cross serrated, curved, TC
- ZS-66715 15.0 cm, cross serrated, straight, TC
- ZS-66615 15.0 cm, cross serrated, curved, TC
- ZS-66718 18.0 cm, cross serrated, straight, TC
- ZS-66618 18.0 cm, cross serrated, curved, TC



Barraquer Micro

with round handle, with lock, tip 0.8 × 1.2 mm

- ZS-66814 14.0 cm, cross serrated, straight, TC
- ZS-66914 14.0 cm, cross serrated, curved, TC
- ZS-66815 15.0 cm, cross serrated, straight, TC
- ZS-66915 15.0 cm, cross serrated, curved, TC
- ZS-66818 18.0 cm, cross serrated, straight, TC
- ZS-66918 18.0 cm, cross serrated, curved, TC



Barraquer

with round handle, with inserted jaws 0.75mm

- ZS-65712 12.0 cm, straight, without lock, smooth
- ZS-65912 12.0 cm, curved, without lock, smooth



Castroviejo

with fat handle, with lock

- ZS-67813** 14.0 cm, smooth, straight, TC
- ZS-67814** 14.0 cm, cross serrated, straight, TC
- ZS-67513** 14.0 cm, smooth, curved, TC
- ZS-67514** 14.0 cm, cross serrated, curved, TC
- ZS-67817** 18.0 cm, smooth, straight, TC
- ZS-67819** 18.0 cm, cross serrated, straight, TC
- ZS-67517** 18.0 cm, smooth, curved, TC
- ZS-67518** 18.0 cm, cross serrated, curved, TC



Castroviejo

with fat handle, without lock

- ZS-69614** 14.0 cm, straight, diamond dusted
- ZS-69714** 14.0 cm, curved, diamond dusted
- ZS-69618** 18.0 cm, straight, diamond dusted
- ZS-69718** 18.0 cm, curved, diamond dusted



Castroviejo

with fat handle, with lock

- ZS-69814** 14.0 cm, straight, diamond dusted
- ZS-69914** 14.0 cm, curved, diamond dusted
- ZS-69818** 18.0 cm, straight, diamond dusted
- ZS-69918** 18.0 cm, curved, diamond dusted



Castroviejo Ryder

with fat handle, with lock

- ZS-70214** 14.0 cm, cross serrated, straight, TC
- ZS-70218** 18.0 cm, cross serrated, straight, TC



ZS-17412 **Adson** 12.0 cm, cross serrated, TC
ZS-17415 15.0 cm, cross serrated, TC



ZS-20412 **Adson** 12.0 cm, serrated, Titanium



ZS-17012 **Adson** 12.0 cm, serrated
ZS-17612 12.0 cm, serrated, Micro



ZS-17912 **Adson Dressing** 12.0 cm, cross serrated



ZS-17512 **Adson** 12.0 cm, cross serrated, 1x2 teeth, TC
ZS-17515 15.0 cm, cross serrated, 1x2 teeth, TC



ZS-20512 **Adson** 12.0 cm, smooth, 1x2 teeth, Titanium



ZS-18012 **Adson Tissue** 12.0 cm, smooth, 1x2 teeth



ZS-18512 **Adson Tubiana** 12.0 cm, 1x2 teeth, with platform 1 mm



Brown-Adson
 ZS-18802 12.0 cm, cross serrated, Brown teeth, TC
 ZS-18805 15.0 cm, cross serrated, Brown teeth, TC



Brown-Adson
 ZS-18812 12.0 cm, Brown teeth



Adson Micro
 ZS-17312 12.0 cm, cross serrated, 1x2 teeth, TC
 ZS-17315 15.0 cm, cross serrated, 1x2 teeth, TC



Par
 ZS-17452 12.0 cm, cross serrated, TC



Adson Delicate
 ZS-16912 12.0 cm, smooth, TC
 ZS-17455 15.0 cm, cross serrated, TC



Gorney-Adson
 ZS-18612D 12.0 cm, 1x2 teeth, with platform, diamond dusted



DeBakey
 ZS-30616 16.0 cm, 1.5 mm jaw
 ZS-30620 20.0 cm, 1.5 mm jaw
 ZS-30624 24.0 cm, 1.5 mm jaw
 ZS-30816 16.0 cm, 2.0 mm jaw
 ZS-30820 20.0 cm, 2.0 mm jaw
 ZS-30824 24.0 cm, 2.0 mm jaw
 ZS-30830 30.0 cm, 2.0 mm jaw
 ZS-30416 16.0 cm, 2.7 mm jaw
 ZS-30420 20.0 cm, 2.7 mm jaw
 ZS-30424 24.0 cm, 2.7 mm jaw
 ZS-30430 30.0 cm, 2.7 mm jaw
 ZS-31016 16.0 cm, 3.5 mm jaw
 ZS-31020 20.0 cm, 3.5 mm jaw
 ZS-31024 24.0 cm, 3.5 mm jaw
 ZS-31030 30.0 cm, 3.5 mm jaw



Castroviejo

- ZS-14915 10,5 cm, 1.5 mm tip, 1x2 teeth, with platform
- ZS-14903 10,5 cm, 3 mm tip, 1x2 teeth, with platform
- ZS-14905 10,5 cm, 5 mm tip, 1x2 teeth, with platform
- ZS-14909 10,5 cm, 9 mm tip, 1x2 teeth, with platform



Castroviejo-Brown

- ZS-18851 11.0 cm, brown teeth



Graefe Iris

- ZS-82010 10.0 cm, smooth, 1x2 teeth



Graefe Iris

- ZS-81010 10.0 cm, serrated



Julian Suture

- ZS-82511 11.0 cm, smooth, curved



Adson-Graefe

- ZS-20012 12.0 cm, multi-toothed



Bishop-Harmon

- ZS-94004 8.5 cm, smooth, 1x2 teeth, fine
- ZS-94006 8.5 cm, smooth, 1x2 teeth



Green Fixation

- ZS-07605 10.0 cm, 5 mm tip, without lock
- ZS-07610 10.0 cm, 10 mm tip, without lock
- ZS-07612 10.0 cm, 12 mm tip, without lock
- ZS-07805 10.0 cm, 5 mm tip, with lock
- ZS-07810 10.0 cm, 10 mm tip, with lock
- ZS-07812 10.0 cm, 12 mm tip, with lock



ZS-22417 **Cushing**
17.0 cm, cross serrated, TC



ZS-22217 **Cushing**
17.0 cm, serrated, Titanium



ZS-22517 **Cushing**
17.0 cm, angled, cross serrated, TC



ZS-22618 **Taylor Cushing**
18.5 cm, cross serrated, bayonet, TC



ZS-25317 **Bonney**
17.5 cm, cross serrated, 1x2 teeth, TC



ZS-11618 **Potts-Smith**
18.0 cm, cross serrated, TC
ZS-11621 21.0 cm, cross serrated, TC
ZS-11625 25.0 cm, cross serrated, TC



ZS-30618 **Gerald**
18.0 cm, cross serrated, 1x2 teeth, TC
ZS-30118 18.0 cm, cross serrated, TC









ZS-26915 **Semken**
15.0 cm, cross-serrated, 1x2 teeth, TC













Jewelers diamond dusted

- | | | |
|-----------------|---|--|
| ZS-33525 |  | 11.5 cm, # 5A, very fine pointed tips |
| ZS-33503 |  | 11.5 cm, # 3, straight, delicate tips |
| ZS-33504 |  | 11.5 cm, # 4, straight, very fine tips |
| ZS-33505 |  | 11.0 cm, # 5, straight, ultra fine tips |
| ZS-33515 |  | 11.0 cm, # 5/45, angled, ultra fine tips |
| ZS-33507 |  | 11.5 cm, # 7, curved, delicate tips |



Jewelers

- | | | |
|-----------------|---|--|
| ZS-33201 |  | 11.5 cm, # 1, straight, standard tips |
| ZS-33012 |  | 11.5 cm, # 3, straight, delicate tips |
| ZS-33225 |  | 11.0 cm, # 5A, very fine pointed tips |
| ZS-33010 |  | 10.5 cm, # 3C, straight, delicate tips |
| ZS-33204 |  | 11.0 cm, # 4, straight, very fine tips |
| ZS-33205 |  | 11.0 cm, # 5, straight, ultra fine tips |
| ZS-33100 |  | 11.0 cm, # 5/45, angled, ultra fine tips |
| ZS-33112 |  | 11.0 cm, # 7, curved, delicate tips |



Micro-Forceps

round handle, with tying platform

- | | |
|-----------------|---------------------------|
| ZS-10415 | 15.0 cm, straight, smooth |
| ZS-10818 | 18.0 cm, straight, smooth |
| ZS-10515 | 15.0 cm, curved, smooth |
| ZS-10918 | 18.0 cm, curved, smooth |





ZS-51916 **Maltz**
16.5 cm,
backward cutting,
straight



ZS-53101 **Lamont**
17.5 cm,
backward cutting, wide,
straight, aggressive teeth



ZS-53102 **Lamont**
17.5 cm,
backward cutting, delicate,
straight, fine teeth



ZS-53103 **Lamont**
17.5 cm,
backward cutting, straight,
fine teeth



ZS-53018 **McIndoe**
17.5 cm,
forward cutting, straight



ZS-52401 **Fomon**
21.5 cm, fine



ZS-52402 **Fomon**
21.5 cm, coarse



ZS-52102 **Fomon**
21.0 cm,
lightweight,
fine



Friedman

21.5 cm,
with coarse teeth
and lewis sweeper

ZS-52521



Fomon

22.0 cm,
lightweight,
coarse

ZS-52101



Miller Colburn File

- ZS-89501 18.0 cm, #1
- ZS-89502 18.0 cm, #2
- ZS-89503 18.0 cm, #3
- ZS-89504 18.0 cm, #4
- ZS-89505 18.0 cm, #5



The TBTS-Style Fiber Optic Retractors feature dual Fiber Optic and Smoke Evacuation Suction Ports to optimize visualization during surgical procedures involving electrosurgery. Ten new patterns and sizes are available to fulfill the clinicians' instrument needs and accommodate variation with patient size. The new TBTS-Style Fiber Optic retractors are available with 3 standard interlocking male fittings for connection to the female fittings on ACMI, Richard Wolf and Storz/Olympus fiber optic cables.

REF#	Description	Type	Blade (L x W)
ZS-897FO	TBTS-Style Fiber Optic Retractor with Suction Port	with Teeth	90 x 24 mm
ZS-898FO	TBTS-Style Fiber Optic Retractor with Suction Port	with Teeth	90 x 30 mm
ZS-899FO	TBTS-Style Fiber Optic Retractor with Suction Port	with Teeth	150 x 30 mm
ZS-900FO	TBTS-Style Fiber Optic Retractor with Suction Port	with Teeth	190 x 30 mm
ZS-901FO	TBTS-Style Fiber Optic Retractor with Suction Port	without Teeth	90 x 24 mm
ZS-902FO	TBTS-Style Fiber Optic Retractor with Suction Port	without Teeth	90 x 30 mm



ZS-897FO



ZS-898FO



ZS-899FO



ZS-900FO



ZS-901FO



ZS-902FO

REF#	Description	Type	Blade (L x W)
ZS-903FO	TBTS-Style Fiber Optic Retractor with Suction Port	without Teeth	150 x 30 mm
ZS-904FO	TBTS-Style Fiber Optic Retractor with Suction Port	without Teeth	190 x 30 mm
ZS-905	TBTS-Style Endoplastic Retractor with Suction Port	-	190 mm



ZS-903FO



ZS-904FO



ZS-905

Adapters

REF#	Description
ZS-2156	Fiber Optic Retractor Adapter For Richard Wolf
ZS-2157	Fiber Optic Retractor Adapter For Storz/Olympus



ZS-2156



ZS-2157

All retractors are available with standard fittings including Storz, Olympus, Wolf and ACMI.

REF#	Description	Handle Length	Blade Width
ZS-884FO	Biggs Face Lift Retractor	9" (22.9 cm)	5.5 cm
ZS-529FO	Biggs Mammoplasty Retractor, Standard	8" (20.3 cm)	5 cm
ZS-530FO	Biggs Mammoplasty Retractor, Narrow	8" (20.3 cm)	3 cm
ZS-895FO	Ferreira Breast Augmentation Retractor	5-1/8" (13 cm)	1" (25 mm) x 6-3/4" (171 mm)
ZS-890FO	Ferreira Face Lift Retractor	4-1/4" (10.8 cm)	7/8" (22 mm) x 4-1/4" (108 mm)



ZS-884FO



ZS-529FO



ZS-530FO



ZS-895FO



ZS-890FO

REF#	Description	Handle Length	Blade Width
ZS-5551FO	Aufricht Retractor	8" (20.3 cm)	7 mm
ZS-490FO	Freeman Flap Retractor	8" (20.3 cm)	1/2" (13 mm)
ZS-491FO	Freeman Flap Retractor	8" (20.3 cm)	1" (25 mm)
ZS-4570FO	Deaver Retractor	8" (20.3 cm)	5/8" (16 mm)
ZS-4571FO	Deaver Retractor	8" (20.3 cm)	1" (25 mm)
ZS-9057FO	Padgett-Deaver Retractor	12" (30.5 cm)	1" (25 mm)
ZS-4270FO	Killian Speculum	5-1/2" (14 cm)	2" (51 mm)



ZS-5551FO

ZS-490FO
ZS-491FO



ZS-4570FO
ZS-4571FO



ZS-9057FO



ZS-4270FO

Biggs Mammoplasty Retractor

- ZS-57001 standard blade, 50 mm
- ZS-57011 standard blade with fiber-optics, 50 mm
- ZS-57021 standard blade with fiber-optics and suction tube, 50 mm
- ZS-57002 narrow blade, 31 mm
- ZS-57012 narrow blade with fiber-optics, 31 mm
- ZS-57022 narrow blade with fiber-optics and suction tube, 31 mm



Converse

- ZS-54105 11.0 cm, nasal retractor, 11x44 mm blade
- ZS-54125 11.0 cm, nasal retractor, 11x44 mm blade, with fiber optics



Aufricht

- ZS-55116 16.0 cm, nasal retractor, 45 mm blade
- ZS-55126 16.0 cm, nasal retractor, 45 mm blade, with fiber optics



Hajek's

- ZS-90301 18.0 cm, cheek retractor



Cronin

- ZS-90416 16.5 cm, cheek retractor



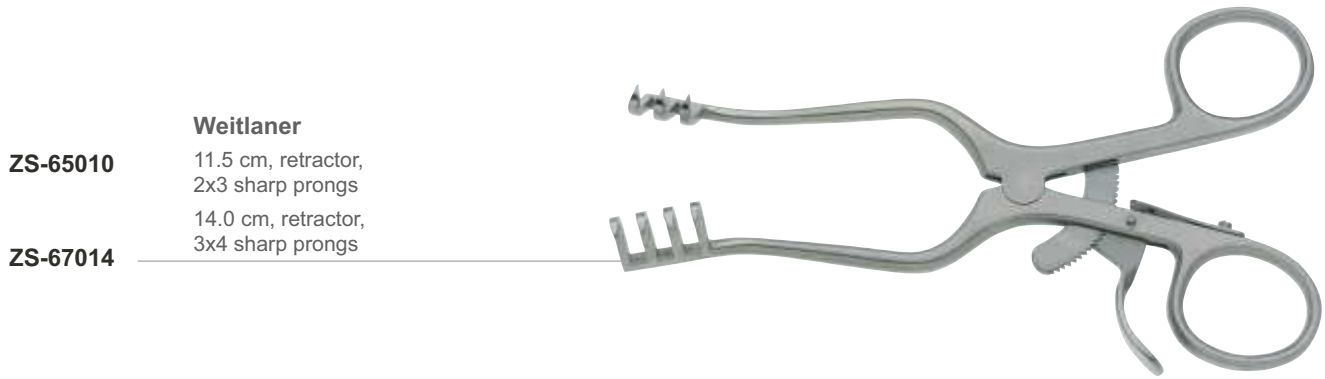

Weitlaner
ZS-65010 11.5 cm, retractor,
2x3 sharp prongs
ZS-67014 14.0 cm, retractor,
3x4 sharp prongs



Swivel double hook
ZS-55508 8.0 cm, sharp, 10 mm



Sheen
ZS-54516 16.0 cm, nasal retractor



Sheen
ZS-54615 15.0 cm, retractor



Cronin
ZS-57215 15.5 cm, lip and nostril retractor



Cottle
ZS-55920 20.0 cm, retractor
with knife guard



Caroline
ZS-56810 11.0 cm, finger retractor

ZS-19516 **Hamra**
16.0 cm, double ended retractor

ZS-55614 **Cottle**
14.0 cm, retractor, double hook, sharp

ZS-55616 **Fomon**
16.0 cm, alar retractor, double hook with ball ends

ZS-55412 **Converse Alar**
10.0 cm, retractor double ended, 10mm / 14mm, blunt

ZS-55511 **Martinez Kilner**
11.5 cm, retractor double hook with thimble, 10mm wide, sharp

ZS-57701 **Fischl**
16.0 cm, "Shoe Horn" retractor

Holtzheimer
self retaining retractor, 4 teeth

ZS-63510 10.0 cm, blunt, straight
ZS-63410 10.0 cm, sharp, straight
ZS-63710 10.0 cm, blunt, curved
ZS-63610 10.0 cm, sharp, curved



ZS-13121 **U.S. Army**
21.0 cm, retractor,
double ended, pair



ZS-25122 **Maxwell Flap**
10.0 cm x 22 mm, four prongs retractor
ZS-25138 10.0 cm x 38 mm, four prongs retractor



ZS-25222 **Freeman Rake**
18.0 cm x 22 mm,
four prongs retractor
ZS-25238 18.0 cm x 38 mm,
four prongs retractor



ZS-24911 **Anderson Bear Claw**
11.0 cm, 3 prongs, sharp
ZS-25011 11.0 cm, 5 prongs, sharp

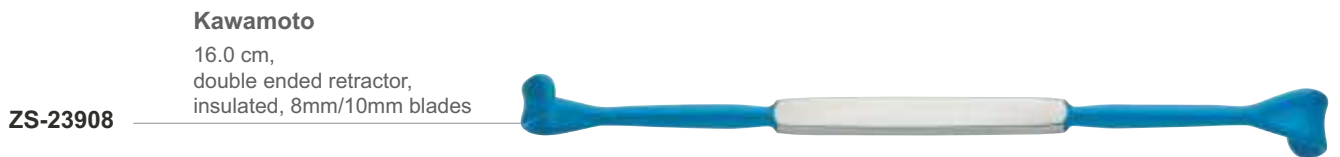

ZS-23908 **Kawamoto**
16.0 cm,
double ended retractor,
insulated, 8mm/10mm blades



ZS-23914 **Kawamoto**
16.0 cm,
double ended retractor,
insulated, 14mm/16mm blades

ZS-56502 **Freeman**
10.0 cm, double skin hook, sharp



ZS-25615 **Yancoskie lift retractor**
15.0 cm, 6 prongs



ZS-25318 **Lift retractor**
18.0 cm, 7 prongs



ZS-17731 **Spatula,**
semi-malleable
31.5 cm, 2.5x15.5 cm blade



ZS-25438 **Gorney Rake**
7.5 cm, retractor with spring, 38mm wide



ZS-37613 **Rollet**
13.0 cm, retractor, delicate,
4 sharp prongs



ZS-26513 **Miller Rake**
13.5 cm, tissue retractor, delicate,
9 sharp prongs



ZS-24214 **Ragnell**
15.0 cm, double ended retractor,
delicate



ZS-24314 **Ragnell-Davis**
14.5 cm,
double ended retractor



ZS-24316 **Kasden**
16.5 cm,
double ended retractor



ZS-16017 **Senn**
17.0 cm,
double ended retractor, sharp

ZS-16117 **Senn**
17.0 cm,
double ended retractor,
blunt



Wise
16.5 cm, orbit retractor,
double ended

ZS-58716



Farr Spring Retractor

14.0 cm x 2.0 cm
14.0 cm x 3.0 cm

ZS-80120
ZS-80121

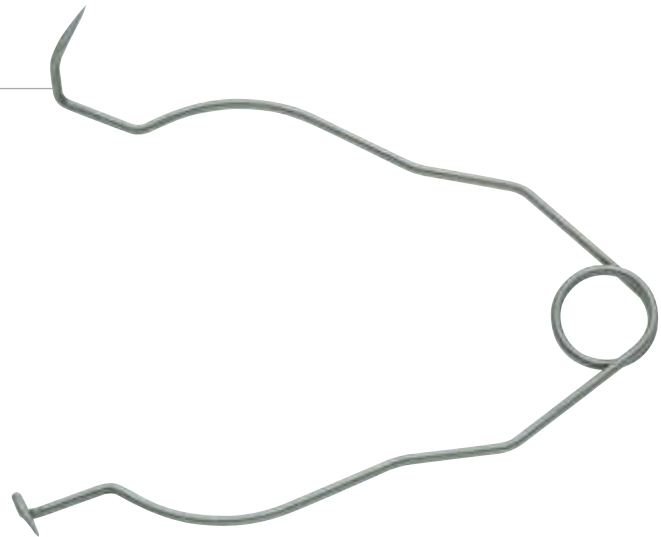

Dingman Mouth Gag complete
16.6 cm frame, 3 tongue blades

ZS-32400

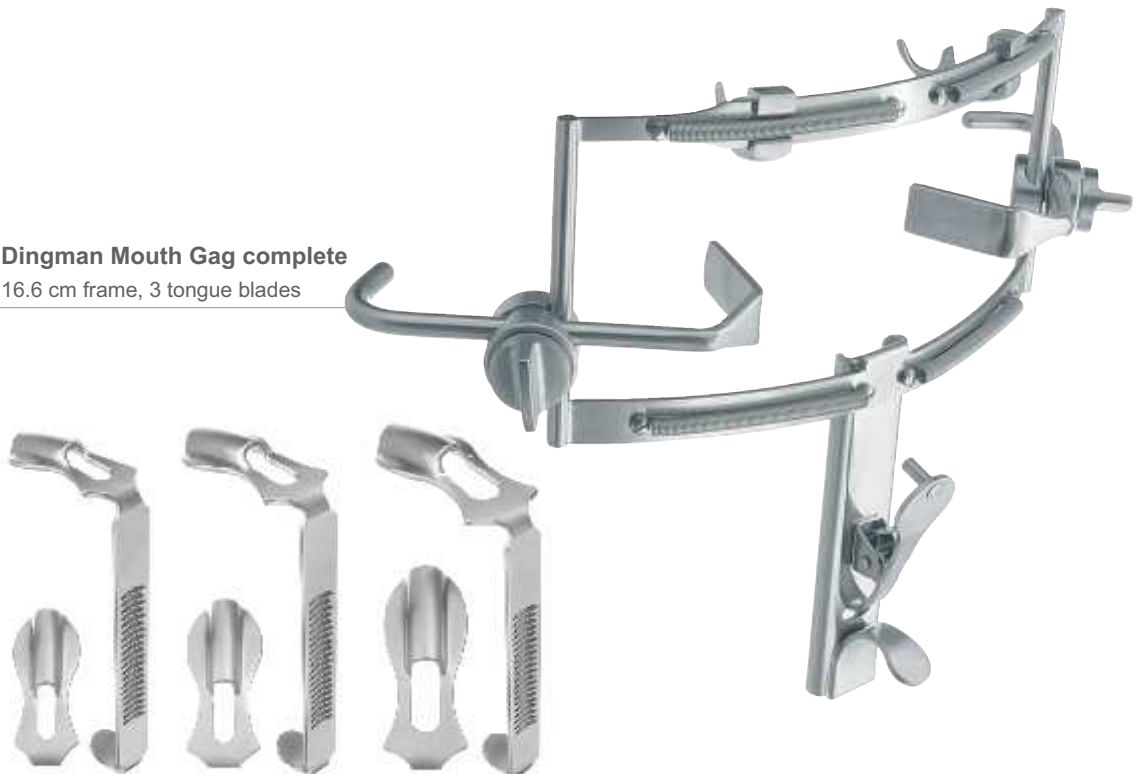



Lead Hand
adult size
child size

ZS-45001
ZS-45002

ZS-30133
ZS-30142

33.0 cm, angled
42.0 cm, angled



ZS-30233

33.0 cm,
angled, malleable

ZS-30242

42.0 cm,
angled, malleable



ZS-30333

33.0 cm,
angled, insulated

ZS-30342

42.0 cm,
angled, insulated



ZS-31133

33.0 cm,
spatulated

ZS-31142

42.0 cm,
spatulated



ZS-31233

33.0 cm,
spatulated, malleable

ZS-31242

42.0 cm, spatulated,
malleable



ZS-31333

33.0 cm,
spatulated, insulated

ZS-31342

42.0 cm, spatulated,
insulated



ZS-31432

32.0 cm,
oval spatulated
blade



ZS-21961 Hockey Stick Breast Dissector, 12-1/4" (31.1 cm) working shaft length, 18-1/8" (46.0 cm) total assembled length, 1-1/8" (28 mm) tip width, lightweight detachable resin handle



ZS-21960 V-Shaped Breast Dissector, 12-1/2" (31.8 cm) working shaft length, 18-1/8" (46.0 cm) total assembled length, 1/2" (13 mm) tip width, lightweight detachable resin handle



ZS-21964 Bullet and Round Tip Breast Dissector, 12-1/4" (31.1 cm) working shaft length w/o tip, 20" (50.8 cm) total assembled length, includes 4 interchangeable tips and one lightweight detachable resin handle



ZS-21965 Breast Dissector Replacement Bullet Tip, Large, 17.2 mm wide x 34.2 mm long, for PM-21964 Breast Dissector

ZS-21966 Breast Dissector Replacement Bullet Tip, Small, 13.9 mm wide x 33.0 mm long, for PM-21964 Breast Dissector

ZS-21967 Breast Dissector Replacement Round Tip, Large, 17.2 mm wide x 29.7 mm long, for PM-21964 Breast Dissector

ZS-21968 Breast Dissector Replacement Round Tip, Small, 13.9 mm wide x 30.7 mm long, for PM-21964 Breast Dissector



ZS-21962 Trocar Breast Tube, 14" (35.6 cm) overall length, Large, 17.3 mm ID, 19.0 mm OD



ZS-21963 Trocar Breast Tube, 13-1/2" (34.3 cm) overall length, Small, 14.0 mm ID, 16.0 mm OD



ZS-21969 Replacement Resin Handle for Transumbilical Breast Augmentation Dissectors (PM-21960, PM-21961 and PM-21964)



ZS-32001	<p>Scalp Dissector 24.0 cm, slightly curved, 12.5 mm wide</p>	
ZS-32011	<p>24.0 cm, slightly curved, 12.5 mm wide, with Ergo Handle</p>	
ZS-32002	<p>Scalp Dissector 24.0 cm, half curved, with angled tip, 12.5 mm wide</p>	
ZS-32012	<p>24.0 cm, half curved, with angled tip, 12.5 mm wide, with Ergo Handle</p>	
ZS-32003	<p>Dissector 24.0 cm, half curved, 7.0 mm wide</p>	
ZS-32013	<p>24.0 cm, half curved, 7.0 mm wide, with Ergo Handle</p>	
ZS-32004	<p>Transoral Dissector 23.5 cm, curved, 7.0 mm wide</p>	
ZS-32014	<p>23.5 cm, curved, 7.0 mm wide, with Ergo Handle</p>	
ZS-32005	<p>Dissector 24.0 cm, straight, 7.0 mm wide</p>	
ZS-32015	<p>24.0 cm, straight, 7.0 mm wide, with Ergo Handle</p>	
ZS-32006	<p>Flap Dissector 24.0 cm, curved, 6.5 mm wide</p>	
ZS-32016	<p>24.0 cm, curved, 6.5 mm wide, with Ergo Handle</p>	
ZS-32007	<p>Frontoglobellar Dissector 26.5 cm, S-shaped</p>	
ZS-32017	<p>26.5 cm, S-shaped, with Ergo Handle</p>	

ZS-32008	Midface Fascia Dissector	
ZS-32018	24.0 cm, S-shaped, with Ergo Handle	
ZS-32009	Flap Dissector	
ZS-32019	22.5 cm, straight, 10 mm wide, with Ergo Handle	
ZS-32101	Periosteal Dissector	
ZS-32111	24.0 cm, S-shaped, 9 mm wide, with Ergo Handle	
ZS-32102	Nerve Dissector	
ZS-32112	24.0 cm, slightly curved, with Ergo Handle	
ZS-32103	Orbital Rim Dissector	
ZS-32113	24.0 cm, half curved, with Ergo Handle	
ZS-32104	Temporal Dissector	
ZS-32114	23.5 cm, straight, with Ergo Handle	
ZS-32105	Periosteal Dissector	
ZS-32115	25.0 cm, curved, with Ergo Handle	



Anderson-Neivert

ZS-46907
ZS-46917
ZS-46927

20.0 cm, straight
20.0 cm, right
20.0 cm, left



Gunter

ZS-46307
ZS-46317
ZS-46327

21.5 cm, straight
21.5 cm, right
21.5 cm, left



Silver

rhinoplastic chisel

ZS-47301
ZS-47302
ZS-47303

18.0 cm, straight
18.0 cm, right
18.0 cm, left



Ristow

ZS-47701
ZS-47702

20.5 cm, right
20.5 cm, left



Rees

handle aluminium anodized

ZS-44802
ZS-44803

20.5 cm, 2 mm
20.5 cm, 3 mm



Sheen angled, Radix Chisel

ZS-44710
ZS-44720

18.0 cm, 10 mm, 10° angle
18.0 cm, 10 mm, 20° angle



Freer Chisel

ZS-45004

16.5 cm, 4 mm, straight



Parkes
16.0 cm, straight

ZS-47518

Cinelli
18.5 cm, 10 mm
18.5 cm, 12 mm
18.5 cm, 14 mm
18.5 cm, 16 mm

ZS-47210
ZS-47212
ZS-47214
ZS-47216

Rubin Type
17.0 cm, 10 mm
17.0 cm, 14 mm
17.0 cm, 16 mm

ZS-46810
ZS-46814
ZS-46816

Parkes Gouge
18.0 cm, 6.5 mm

ZS-47918

Sheehan
16.0 cm, 2 mm
16.0 cm, 3 mm
16.0 cm, 4 mm
16.0 cm, 5 mm
16.0 cm, 6 mm
16.0 cm, 9 mm
16.0 cm, 10 mm

ZS-46702
ZS-46703
ZS-46704
ZS-46705
ZS-46706
ZS-46709
ZS-46710

Converse
18.0 cm, 2 mm
18.0 cm, 3 mm
18.0 cm, 4 mm
18.0 cm, 5 mm
18.0 cm, 6 mm
18.0 cm, 7 mm
18.0 cm, 8 mm
18.0 cm, 9 mm
18.0 cm, 10 mm
18.0 cm, 11 mm
18.0 cm, 12 mm
18.0 cm, 15 mm

ZS-47102
ZS-47103
ZS-47104
ZS-47105
ZS-47106
ZS-47107
ZS-47108
ZS-47109
ZS-47110
ZS-47111
ZS-47112
ZS-47115

ZS-69632
ZS-69702

Mead
17.0 cm, 320 g
pair of interchangeable faces



ZS-69114

Nylon
18.5 cm, head Nylon / Nylon



ZS-69214

Nylon
18.5 cm, head Nylon / Stainless



ZS-68625

Gerzog
18.0 cm, 250 g = 8 oz



ZS-25318 **Gunter**
18.0 cm, serrated, TC



ZS-25520 **Gorney**
18.5 cm, straight



ZS-53800 **Cottle**
cartilage-crusher, including forceps for removal



Joseph Saw

- H146-53219 19.0 cm, left bayonet
- H146-53419 19.0 cm, right bayonet



Curettes

Converse double ended curette

- ZS-76321 21.0 cm, 7.0 x 10.0 and 6.5 x 8.5mm



Fox dermal curette

- ZS-12803 14.0 cm, 3 mm oval
- ZS-12804 14.0 cm, 4 mm oval
- ZS-12805 14.0 cm, 5 mm oval



Septum Forceps

Asch straightening Forceps

- ZS-57123 23.0 cm



Walsham straightening Forceps

- ZS-57223 23.0 cm, straight
- ZS-57323 23.0 cm, left
- ZS-57523 23.0 cm, right



ZS-11201
ZS-11202
ZS-11203

Vienna
14.0 cm, for baby
14.0 cm, for child
14.0 cm, for adult



ZS-12035
ZS-12050
ZS-12075
ZS-12090

Killian
13.0 cm, 35 mm
13.0 cm, 50 mm
13.0 cm, 75 mm
13.0 cm, 90 mm



ZS-12435
ZS-12450
ZS-12475
ZS-12490

Cottle
14.0 cm, 35 mm
14.0 cm, 50 mm
14.0 cm, 75 mm
14.0 cm, 90 mm





- ZS-41645** **Freer**
19.0 cm, tip 4.5 mm, sharp/blunt
- ZS-41665** **Freer**
19.0 cm, tip 6.5 mm, sharp/blunt
- ZS-40418** **McCullough**
18.5 cm
- ZS-50318** **Woodson**
20.0 cm
- ZS-69907** **Obwegeser Periosteal**
18.0 cm, 7 mm
- ZS-69911** **Obwegeser Periosteal**
18.0 cm, 11 mm
- ZS-57719** **Boies**
19.5 cm
- ZS-56600** **Carlin**
15.5 cm, chin implant periosteal elevator
- ZS-58500** **Clodius**
orbital retractor, double ended, 13 mm / 20 mm

Frazier Skin Hook

ZS-21413
ZS-21418

13.0 cm, sharp
18.0 cm, sharp



O'Conner Iris Skin Hook

ZS-20913

12.5 cm, sharp



Converse Skin Hook

ZS-20501
ZS-20503

19.0 cm, small
19.0 cm, large



Joseph Skin Hook

ZS-21601
ZS-21602
ZS-21605
ZS-21607
ZS-21610

16.0 cm, single hook
16.0 cm, 2 mm double hook
16.0 cm, 5 mm double hook
16.0 cm, 7 mm double hook
16.0 cm, 10 mm double hook



Kleinert-Kutz Hook

ZS-20803
ZS-20805
ZS-20807

16.0 cm, 3 mm
16.0 cm, 5 mm
16.0 cm, 7 mm



ZS-55218 **Millard Thimble Hook**
18 mm wide, double hook



ZS-55701 **Cottle Tenaculum**
15.0 cm, Fig. 1
ZS-55702 15.0 cm, Fig. 2
ZS-55703 15.0 cm, Fig. 3



ZS-21201 **Guthrie Double Hook**
12.0 cm, 2.5 mm
ZS-21202 12.0 cm, 3.0 mm



ZS-20413 **Tyrell Skin Hook**
13.0 cm



ZS-56018 **Gillies Skin Hook**
18.0 cm, Fig. 1
ZS-56218 18.0 cm, Fig. 2



ZS-56614 **Barsky Double Skin Hook**
15.0 cm, 5 mm



ZS-31911 Thorpe Precision Caliper
12.5 cm



ZS-58307 Castroviejo Caliper
9.0 cm



ZS-31710 Jameson Caliper
10.0 cm



ZS-31811 Thorpe Caliper, angled
12.0 cm





ZS-10400 **Grossmann**
Areola Marker
4 sizes



ZS-10534 **Freeman**
Areola Marker
34 mm
ZS-10536 36 mm
ZS-10538 38 mm
ZS-10542 42 mm
ZS-10545 45 mm
ZS-10550 50 mm



ZS-11038 **McKissock "keyhole"**
used in conjunction
with Freeman Areola Marker
38 mm
ZS-11042 42 mm
ZS-11045 45 mm



ZS-10738 **Freeman**
38/42 mm diameter
ZS-10742 42/45 mm diameter



ZS-11414 **Ackerman**
Areola Marker
10.0 cm
ZS-11416 11.5 cm

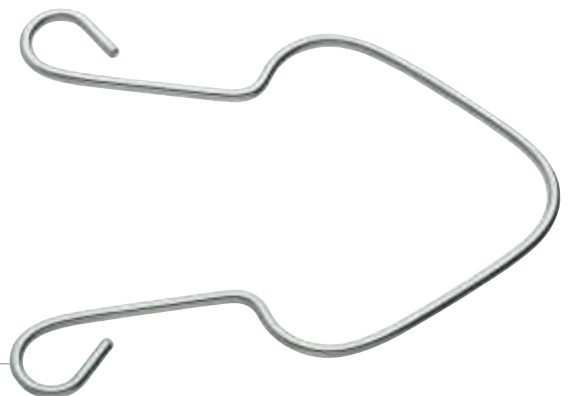

ZS-20216
ZS-20316

D'Assumpcao F/L
16.0 cm
16.0 cm, with ratchet



ZS-20916

Pitanguy Flap Demarcator
16.0 cm, facial



ZS-20714
ZS-20614

Marten Flap
14.5 cm
14.5 cm, with ratchet



Hartmann Mosquito
ZS-21010 10.0 cm, straight
ZS-21110 10.0 cm, curved



Halstead Mosquito
ZS-23012 12.5 cm, straight, 1x2 teeth
ZS-23112 12.5 cm, curved, 1x2 teeth
ZS-22012 12.5 cm, straight
ZS-22112 12.5 cm, curved



Kelly
ZS-24014 14.0 cm, straight
ZS-24114 14.0 cm, curved



Crile
hemostatic forceps
ZS-25014 14.0 cm, straight
ZS-25114 14.0 cm, curved
ZS-26316 16.0 cm, curved



Jones Towel
ZS-10309 9.0 cm



Rochester Pean
hemostatic forceps

- ZS-31014 14.0 cm, straight
- ZS-31016 16.0 cm, straight
- ZS-31020 20.0 cm, straight
- ZS-31116 16.0 cm, curved
- ZS-31118 18.0 cm, curved
- ZS-31120 20.0 cm, curved



Rochester-Ochsner
hemostatic forceps

- ZS-32014 14.0 cm, straight, 1x2 teeth
- ZS-32114 14.0 cm, curved, 1x2 teeth
- ZS-32016 16.0 cm, straight, 1x2 teeth
- ZS-32116 16.0 cm, curved, 1x2 teeth



Adson
hemostatic forceps

- ZS-41018 18.5 cm, straight
- ZS-41118 18.5 cm, curved



Foerster Sponge Holding

- 18.0 cm ZS-17018
- 20.0 cm ZS-17020
- 25.0 cm ZS-17025



Lahey Vulsellum
ZS-52015 15.0 cm
ZS-52020 20.0 cm



Allis
14.0 cm, 4:5 teeth, Allis Baby ZS-10214
15.0 cm, 4:5 teeth ZS-11015
15.0 cm, 5:6 teeth ZS-12015
19.0 cm, 5:6 teeth ZS-12019

Backhaus Towel
ZS-11109 9.0 cm
ZS-11111 11.0 cm
ZS-11113 13.0 cm
ZS-11115 15.0 cm



Lorna Towel
11.0 cm ZS-12111
13.0 cm ZS-12113

Ballenger Swivel

- ZS-39003 20.0 cm, straight, 3 mm blade
- ZS-39004 20.0 cm, straight, 4 mm blade
- ZS-39005 20.0 cm, straight, 5 mm blade
- ZS-39203 20.0 cm, bayonet, 3 mm blade
- ZS-39204 20.0 cm, bayonet, 4 mm blade
- ZS-39205 20.0 cm, bayonet, 5 mm blade



Freer Mucosa Knife

- ZS-37415 15.0 cm, "D" pattern



Silver Dermatome

- ZS-48219 19.0 cm



Watson Dermatome

- ZS-48230 30.0 cm, complete
- ZS-48401 spare blade (1pc.)



Schink

- ZS-55521 31,0 cm / 12 1/4"



Foerster

- ZS-14027 27.0 cm, capsulotomy knife



02-192
STANDARD
No. 3
Solid



02-193
No. 3
Solid



02-194
No. 3
Solid



02-195
No. 3 L
Straight
Solid



02-196
No. 3 L
Angled
Solid

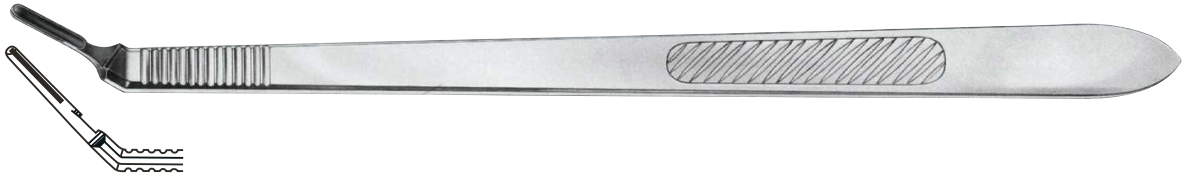

02-197
No. 7
Solid



02-199
Hollow-Round



02-185
STANDARD
No. 4
Solid



02-186
Double Handel
No. 4 + No. 3
Solid



02-187
No. 4 L
Straight
Solid



02-188
No. 4 L
Solid Angled



ZS-15016
ZS-15116

Lempert
16.0 cm, straight
16.0 cm, curved



ZS-20118

Beyer
18.0 cm, curved



ZS-32519 **Jansen Middleton**
nasal cutting forceps
19.5 cm



ZS-21002 **Takahashi Cutting Forceps**
11.5 cm, working length, 2.5x8 mm bite



ZS-28314 **Kleinert-Kutz Forceps**
14.0 cm, straight
ZS-28414 14.0 cm, curved



Ruler

graduated in mm and inches

- ZS-34010 10.0 cm
- ZS-34020 20.0 cm
- ZS-34030 30.0 cm
- ZS-34050 50.0 cm



Barron Suction Tubes

- ZS-10103 13.0 cm, 3 french
- ZS-10105 13.0 cm, 5 french
- ZS-10107 13.0 cm, 7 french



Yankauer Aspiration Tube

27.0 cm, complete
with suction tip
and connector

ZS-15027



Universal Flat Nose Pliers

20.0 cm

ZS-53820



Wire Seizing Forceps

- ZS-53202 18.0 cm, 4 mm
- ZS-53203 18.0 cm, 6 mm



ZS-56814 **Needle Nose Pliers**
14.0 cm, cross-serrated



ZS-53803 **General Purpose Pliers**
18.0 cm



ZS-54717 **Wire/Pin Cutter**
18.0 cm, 1.7 wire, TC
ZS-54522 22.0 cm, 2.5 wire, TC



ZS-54618 **Wire/Pin Cutter**
18.0 cm, TC



Iconoclasts are used in breast augmentation, reduction and lift procedures to facilitate blunt dissection. The iconoclast utilizes the gripping strength of the clinician's hand rather than the spreading strength to help minimize hand fatigue during a procedure.

REF#	Description	Length	Blade
ZS-638	Iconoclast, Large	11-1/2" (29.2 cm)	5-3/4" (14.6 cm)
ZS-639	Iconoclast, Small	8-3/4" (22.2 cm)	3-1/4" (8.3 cm)



ZS-638



ZS-639

Lipo Hand piece

with lever mechanism,
quick lock mechanism

ZS-40010



with thumb control,
quick lock mechanism

ZS-40020



Lipo Hand piece

with thumb control,
luer lock

ZS-40030



Triport

working length Ø

ZS-46320	200 mm	3 mm
ZS-46325	250 mm	3 mm
ZS-46420	200 mm	4 mm
ZS-46425	250 mm	4 mm
ZS-46430	300 mm	4 mm
ZS-46525	250 mm	5 mm
ZS-46530	300 mm	5 mm



Mercedes

working length Ø

ZS-47320	200 mm	3 mm
ZS-47325	250 mm	3 mm
ZS-47420	200 mm	4 mm
ZS-47425	250 mm	4 mm
ZS-47430	300 mm	4 mm
ZS-47525	250 mm	5 mm
ZS-47530	300 mm	5 mm



Spirale

working length Ø

ZS-48320	200 mm	3 mm
ZS-48325	250 mm	3 mm
ZS-48420	200 mm	4 mm
ZS-48425	250 mm	4 mm
ZS-48430	300 mm	4 mm
ZS-48525	250 mm	5 mm
ZS-48530	300 mm	5 mm



Cobra

working length Ø

ZS-43315	150 mm	3 mm
ZS-43320	200 mm	3 mm
ZS-43325	250 mm	3 mm
ZS-43420	200 mm	4 mm
ZS-43425	250 mm	4 mm
ZS-43430	300 mm	4 mm
ZS-43525	250 mm	5 mm
ZS-43530	300 mm	5 mm



Spirale

working length Ø

ZS-44315	150 mm	3 mm
ZS-44320	200 mm	3 mm
ZS-44325	250 mm	3 mm
ZS-44420	200 mm	4 mm
ZS-44425	250 mm	4 mm
ZS-44430	300 mm	4 mm
ZS-44525	250 mm	5 mm
ZS-44530	300 mm	5 mm



Shark

working length Ø

ZS-45315	150 mm	3 mm
ZS-45320	200 mm	3 mm
ZS-45325	250 mm	3 mm
ZS-45420	200 mm	4 mm
ZS-45425	250 mm	4 mm
ZS-45430	300 mm	4 mm
ZS-45525	250 mm	5 mm
ZS-45530	300 mm	5 mm



Triport

working length Ø

ZS-41315	150 mm	3 mm
ZS-41320	200 mm	3 mm
ZS-41325	250 mm	3 mm
ZS-41330	300 mm	3 mm
ZS-41420	200 mm	4 mm
ZS-41425	250 mm	4 mm
ZS-41430	300 mm	4 mm
ZS-41525	250 mm	5 mm
ZS-41530	300 mm	5 mm



Monoport

working length Ø

ZS-42315	150 mm	3 mm
ZS-42320	200 mm	3 mm
ZS-42325	250 mm	3 mm
ZS-42330	300 mm	3 mm
ZS-42420	200 mm	4 mm
ZS-42425	250 mm	4 mm
ZS-42430	300 mm	4 mm
ZS-42525	250 mm	5 mm
ZS-42530	300 mm	5 mm



CONTACT

WEBSITE: WWW.ZSINSTRUMENT.COM

EMAIL: INFO@ZSINSTRUMENT.COM

PH: 92 3480197097

ADDRESS: S.I.E SIALKOT PAKISTAN 51310