

04

2025

# ORTHOPEDIC CATALOGUE

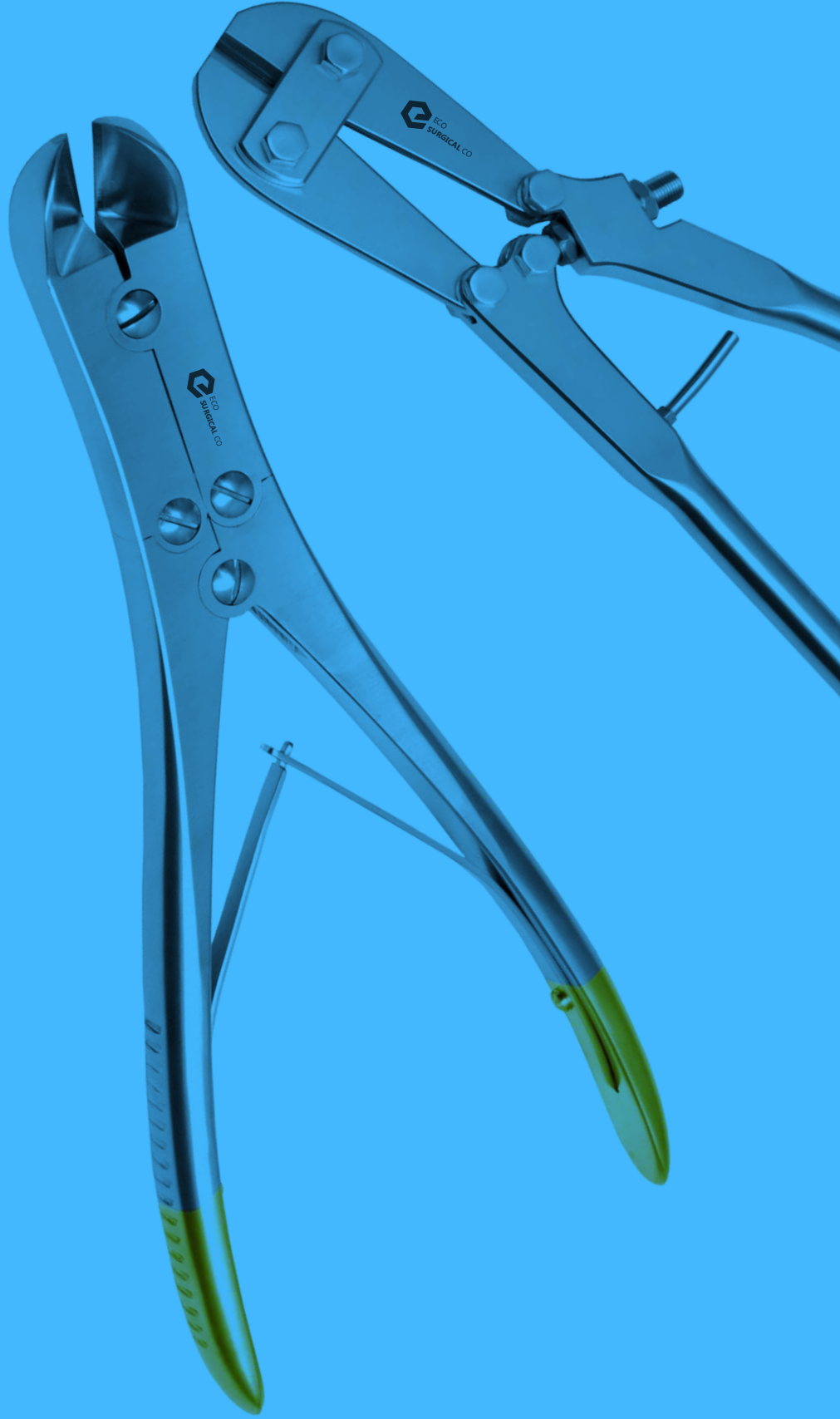

# S01

BONE LEVERS

01-09

# S02

BONE HOOKS  
RETRACTORS

10-16  
17-29

# S03

BONE HOLDING FORCEPS  
PELVIC REDUCTION INSTRUMENTS  
BONE HOLDING CLAMPS

30-40  
41-43  
44-45

# S04

TENDON RETRACTORS  
TENDON & CARTILAGE  
MENISCUS

46-51  
52-53  
54-55

# S05

BONE CURETTES  
HIP REVISION INSTRUMENTS

56-70  
71-76

# S06

PERIOSTEAL ELEVATORS  
& RASPATORIES

77-89

# S07

OSTEOTOMES

90-100

# S08

MALLETS & TAMPS

101-112

# S09

FILES AND RASPS

113-117

# S10

BONE RONGEURS

118-130

# S11

BONE CUTTERS

131-135

# S12

PLASTER INSTRUMENTS

136-145

# S13

AMPUTATION SAW & KNIVES

146-149

# S14

MEASURING INSTRUMENTS

150-153

# S15

PODIATRIC

154-159

# S16

PLIERS & WIRE CUTTERS

160-171

SCISSORS

172-173

LOCKING PLIERS

175-176

WIRE GRIPPING

177

WIRE BENDING

178

WIRE GUIDE

179-180

WIRE TIGHTENING

181

WIRE EXTENSION

182-183

# S17

REAMERS

184

AWLS

185

HAND DRILLS

186-192

HIP REVISION INSTRUMENTS

193

# S18

MISCELLANEOUS

194

SCREWDRIVERS

195-198

PUNCHES

199-200

SCISSORS

201



SECTION  
01

BONE LEVERS & ELEVATORS

Mini Bone Lever  
14cm/5½"  
2.8mm width

ES-690-14



Hohmann Style Mini-Bone Lever  
16cm/6¼"

	Width
ES-693-06	6mm
ES-693-08	8mm



Phalangeal Lever  
14cm/5½"  
5mm width

ES-691-14



Buck-Gramcko Lever  
15cm/6"  
2mm/7.5mm width

ES-690-15



Mini-Cobra Bone Lever  
16cm/6¼"

	Width	Length
ES-693-15	15mm	16cm
ES-693-16	16mm	12cm



McGlamry Metatarsal Lever  
17cm/6½"  
Sharp

	Width
ES-694-10	9mm
ES-694-12	11mm
ES-694-14	13mm
ES-694-16	15mm
ES-694-19	19mm



Hohmann Bone Lever  
22cm/8½" length  
8mm width

ES-695-08



Hohmann Bone Lever  
24cm/9½" length  
18mm width

ES-695-18



Hohmann Bone Lever  
24.5cm/9½" length  
43mm width

ES-695-43



Hohmann Large Bone  
25cm/9¾" length  
70mm width

ES-695-70



Hohmann Bone Lever  
29cm/11½" length  
35mm width

ES-705-35



Hohmann Bone Lever  
27.5cm/10¾" length  
24mm width

ES-707-24



Hohmann Bone Lever  
23.5cm/9" length  
43mm width

ES-703-43



Hohmann Bone Lever  
25.5cm/10" length  
22mm width

ES-703-22



Hohmann Bone Lever  
25cm/9¾" length  
22mm width

ES-709-22



Lange-Hohmann Modif Lever  
26.5cm/10½" length  
30mm width

ES-712-01



Lange-Hohmann Modif Lever  
29cm/11½" length  
33mm width

ES-712-02

Hohmann-Aldinger Lever  
27cm/10¾" length  
24mm width

ES-712-03



Bennett Bone Lever  
24cm/9½" length

	Width
ES-713-43	43mm
ES-713-60	60mm



Blount Bone Lever  
26cm/10¼" length

ES-713-26



Blount Bone Lever  
26cm/10¼" length

ES-717-26



Schumacher-Wagner  
Lever  
34.5cm/14" length  
37mm width

ES-712-04



Schumacher Lever  
29cm/11½" length  
35mm width

ES-712-05

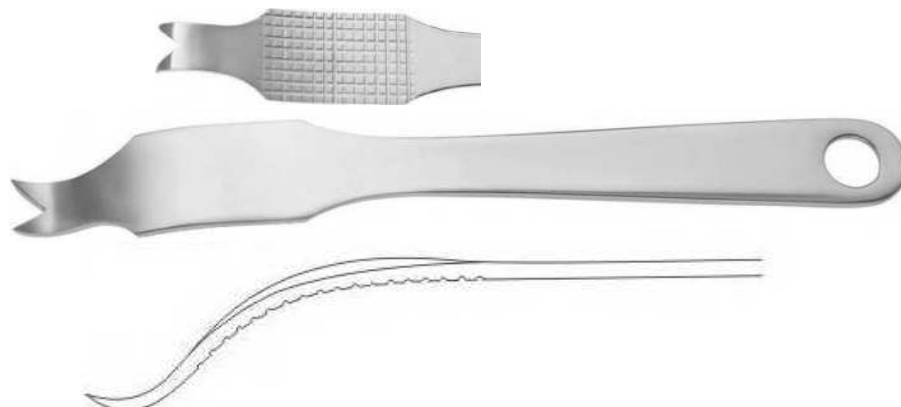

Wagner Bone Lever  
22cm/8½"  
17mm width



ES-719-06

Chandler Bone Lever  
16cm/6¼"

	Width	Length
ES-719-08	13mm	18cm
ES-719-09	19mm	20cm
ES-719-10	25mm	23cm
ES-719-11	30mm	25cm

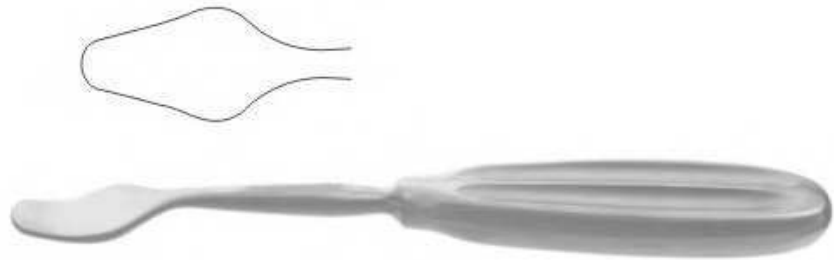

Verbrugge -Muller Bone Lever

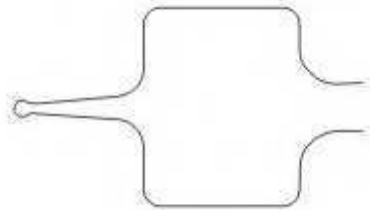

25.5cm/10" length  
65mm width  
ES-719-02

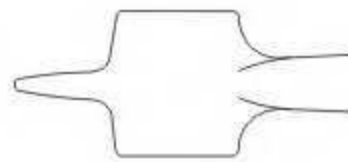

24cm/9½" length  
42mm width  
ES-719-01

Taylor Bone Lever  
16.5cm/6½"

	Width
ES-694-10	100 x 30mm
ES-694-12	70 x 30mm





Long Curved Hohmann Inferior Hip Elevator  
40cm/16" length  
22mm width

ES3022-40



Modified Hohmann Elevator  
90° angled

	Width
ES7750 -10	10mm
ES7750 -18	18mm
ES7750 -25	25mm
ES7750 -43	43mm
ES7750 -70	70mm

Modified Cobra Aufrang Elevator  
33cm/13" long blade  
30mm x 100mm

ES7742-10



Shallow Bone Elevator  
25cm/9<sup>3</sup>/<sub>4</sub>" length

ES7755-25



Concave Moor Elevator  
33cm/13" long blade

ES7742-20



Murphy Bone Skid Elevator  
23cm/9" length  
For dislocation of the femoral head  
Double ended



ES0589-23



Murphy Insulated  
Bone Skid Elevator  
33cm/13" length  
Double ended

ES3035-33

Infero-Posterior Acetabular Capsule Retractor

35cm/14" length

Right  
ES7772-10

Left  
ES7772-20



PCL Retractor  
25cm/10" length  
To straddle the cruciate ligament  
4mm wide prongs  
21mm wide tips

ES7761-10

Wide Prong PCL Retractor  
25cm/10" length  
To straddle the cruciate ligament  
5mm wide prongs  
23mm wide tips

ES7762-10

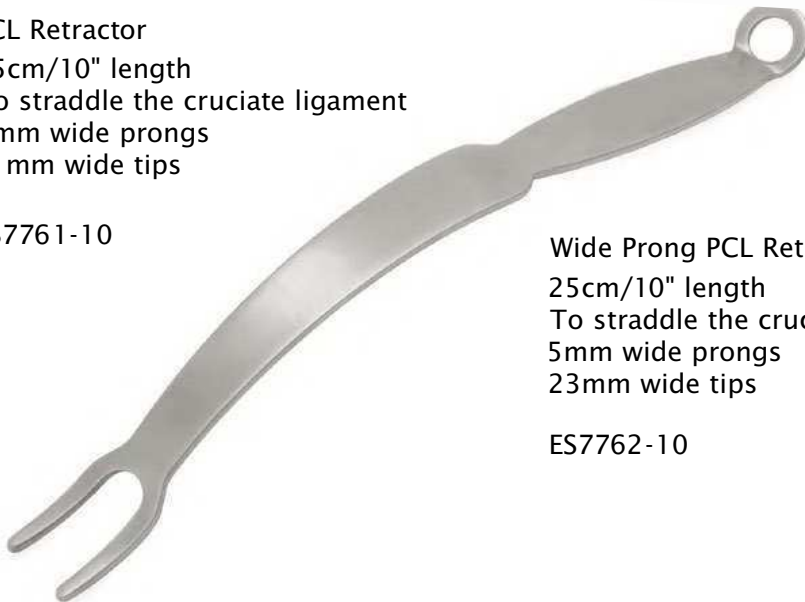

Trethowan Bone Lever  
21.5cm/8½" length

ES-715-21



Lanes Bone Lever  
25.5cm/10" length

ES-715-25



Fagge Bone Lever  
27.5cm/10¾" length

ES-716-27



Bristow Periosteal Lever  
23cm/9" length  
Curved sharp  
10mm width

ES-718-23



Femoral Dislocation Lever  
31cm/12½" length  
26mm width

ES-719-31



Muller Femoral Retractor  
35cm/13½" length  
28mm width

ES-719-31



For retraction of the femoral neck



## BONE HOOKS & RETRACTORS

Bone Hook Sharp  
24.5cm/9<sup>3</sup>/<sub>4</sub> " length  
Sharp

ES9050-24



Blunt Hook  
20cm/8" length

ES9051-20



Wroblenski Dislocating Hook  
25cm/10" length  
For hooking around the neck of the Femur

ES9055-25



McMinn Dislocating Hook  
25cm/10" length  
Blunt hook with Tufnol handle

ES9057-25



Frazier  
13cm/5" length  
Dura Hook

ES-108-13 Sharp  
ES-109-13 Blunt



Graefe  
12.5cm/4¾" length  
Skin Hook

ES-110-13 Sharp  
ES-111-13 Blunt

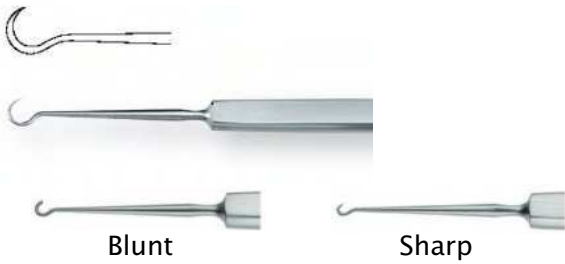

O'Connor  
12cm/4¾" length  
12cm/4¾" length

ES-112-12



Cushing  
14cm/5½" length  
Fine Wound Retractor

ES-115-14



Kilner  
15cm/6" length  
Fine Wound Retractor

ES-116-15



Kilner (Catspaw)  
15cm/6" length  
Fine Wound Retractor

ES-117-15



Jaeger  
13cm/5" length  
Fine Wound Hook



ES-121-13 Small  
ES-122-13 Large



Small



Large

Cottle  
15cm/6" length  
Tenaculum Hook



ES-1ES-15 120°  
ES-125-15 180°



120° retrograde curved



180° retrograde curved

Mannerfelt  
15.5cm/6" length  
Hook Sharp



ES-130-15



Mannerfelt  
15.5cm/6" length  
Small Curve



2Prongs  
ES-132-15 Sharp  
ES-133-15 Blunt



Blunt



Sharp

3Prongs  
ES-136-15 Sharp  
ES-137-13 Blunt

Mannerfelt  
15.5cm/6" length  
Long Curve



2Prongs  
ES-140-15 Sharp  
ES-141-15 Blunt



Blunt



Sharp

3Prongs  
ES-144-15 Sharp  
ES-145-13 Blunt



Joseph  
16cm/6¼" length  
Hooklet, Sharp

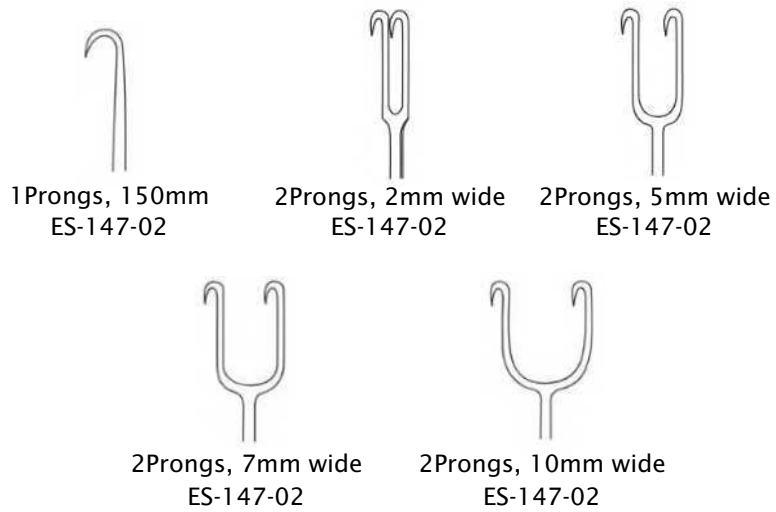

Freer  
15cm/6¼" length  
Skin Hook, Double  
2.5mm wide



ES-149-15 Sharp  
ES-150-15 Blunt

Guthrie  
16cm/6¼" length  
Hook, Sharp



ES-151-16 Fig.1  
ES-152-16 Fig.2



Lahey  
12cm/4¾" length  
Wound Retractor Sharp

ES-154-12 2 Hooks  
ES-155-12 3 Hooks



**Cottle**

14cm/5½" length  
Hooklet



- ES-156-14 2 Sharp Prongs
- ES-157-14 Ball End Prong, Left
- ES-158-14 Ball End Prong, Right

**Cottle Neivert**

22cm/8¾" length  
Double-Ended Retractor

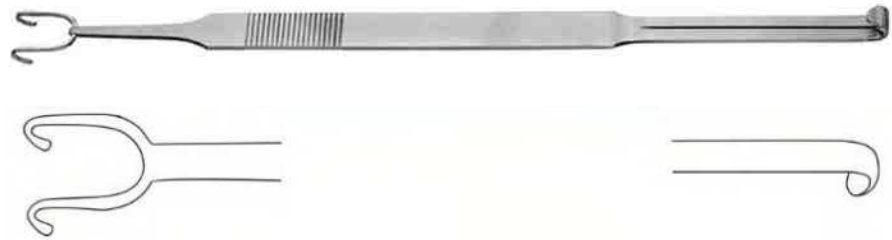

ES-160-22

**Penn-Humby**

11.5cm/4½" length  
Double Skin Hook, Sharp



ES-162-12

**Barsky**

15cm/6" length  
Fine Wound Retractor, Detachable



- ES-155-15 Single Prong
- ES-155-15 Double Prong

**Gillies**

18cm/7" length  
Fine Wound Retractor, Sharp



- ES-166-18 Fig.1
- ES-167-18 Fig.2

**RZ**

17.5cm/6¾" length  
Square Round Hook



- ES-168-17 Blunt
- ES-169-17 Sharp

**Fomon**  
16cm/6¼" length  
Hooklet



ES-171-16

**Fomon**  
13cm/6¼" length  
Hooklet, Insulated



ES-172-16

**Mannerfelt (Mod.)**  
15.5cm/6" length  
Forked Hooked, retrograde curved



ES-172-16

ES-172-16

**Mannerfelt**  
17.5cm/6¾" length  
Square Handle, Fork Retractor



**2 Prongs**  
ES-175-15 15mm  
ES-175-23 23mm

**Rake (Flexible)**  
16.5cm/6½" length

**2Prongs**  
ES-176-16 Sharp  
ES-177-16 Blunt

**3Prongs**  
ES-178-16 Sharp  
ES-179-16 Blunt

**4Prongs**  
ES-180-16 Sharp  
ES-181-16 Blunt



Volkman  
21.5cm/8½" length



Sharp



ES-171-16



ES-172-16



ES-173-16



ES-174-16



ES-175-16

Blunt



ES-176-16



ES-177-16



ES-178-16



ES-179-16



ES-180-16

Semi Sharp



ES-181-16



ES-182-16



ES-183-16



ES-184-16



ES-185-16

Kocher  
22cm/8¾" length  
Semi sharp teeth



Sharp



ES-171-18



ES-172-18



ES-173-18



ES-174-18



ES-175-18

Blunt



ES-176-18



ES-177-18



ES-178-18



ES-179-18



ES-180-18

Semi Sharp



ES-181-18



ES-182-18



ES-183-18



ES-184-18



ES-185-18

Meyerding Retractor



	Blade size	Length
ES-206-22	50mm x 16mm	23cm/9"
ES-206-23	70mm x 25mm	23cm/9"
ES-206-25	90mm x 50mm	25.5cm/10"

23cm/9" 23cm/9" 25.5cm/10"

Langenbeck Retractor  
21.5cm/8½" length  
Ring Handle



	Blade size	
ES-210-06	22mm x 6mm	Small
ES-210-13	45mm x 13mm	Medium
ES-210-25	65mm x 25mm	Large
ES-210-20	90mm x 20mm	Extra large

Langenbeck Retractor  
21.5cm/8½" length  
Solid Handle

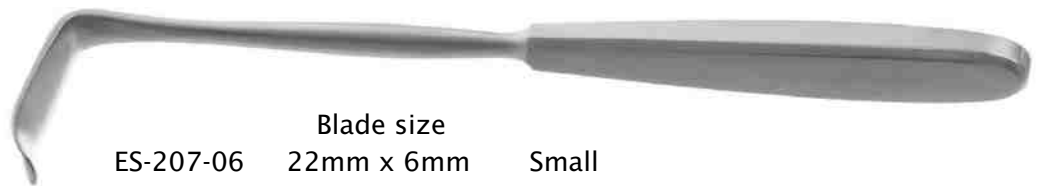

	Blade size	
ES-207-06	22mm x 6mm	Small
ES-207-13	45mm x 13mm	Medium
ES-207-25	65mm x 25mm	Large
ES-207-20	90mm x 20mm	Extra large

McCulloch Nerve Root Retractor  
12.5cm/5" length  
6mm Tip

ES-207-55



Kocher  
Reusable, 60x20mm  
23cm/6¾" length  
ES-3ES-20



21.5cm/8½" length  
25x 06mm  
ES-317-01

21.5cm/8½" length  
41 x 11mm  
ES-317-05

Koerte  
21.5cm/8½" length  
Retractor, 8 Prongs

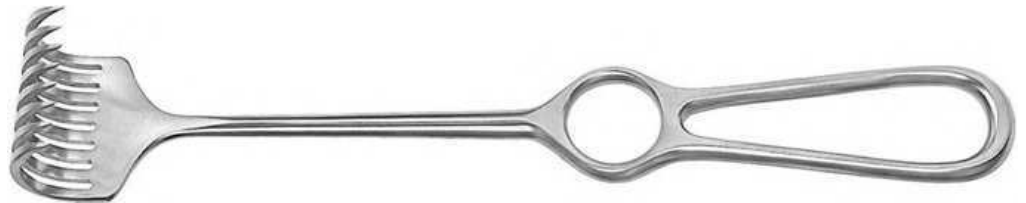

ES-207-40 40mm x 30mm Sharp  
ES-207-41 40mm x 30mm Blunt

Koerte-Wagner  
28cm/11" length  
Semi Sharp  
8 Prongs, 25x40mm



ES-208-28

Israel  
25cm/10" length



4 Prongs, 40x40mm  
ES-209-01



6 Prongs, 50x60mm  
ES-209-03



5 Prongs, 45x50mm  
ES-209-02



6 Prongs, 70x70mm  
ES-209-04

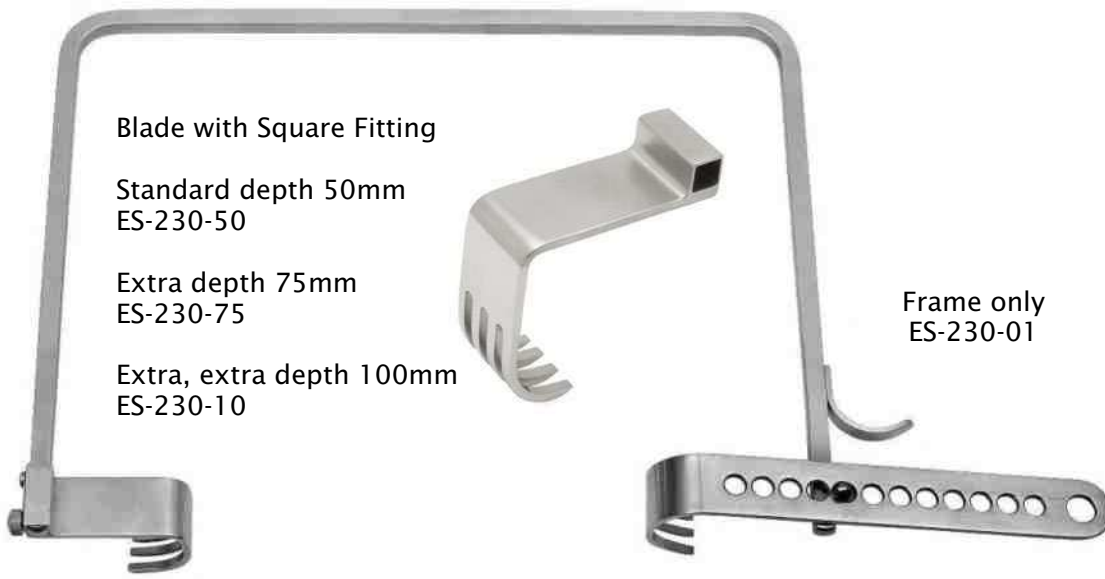

Blade with Square Fitting

Standard depth 50mm  
ES-230-50

Extra depth 75mm  
ES-230-75

Extra, extra depth 100mm  
ES-230-10

Frame only  
ES-230-01

Blade with Round Fitting



Standard depth 40mm  
ES-231-40

Extra depth 75mm  
ES-231-75

Extra, extra depth 100mm  
ES-231-10

ES-230-00 Complete Set - Basic  
Consisting of:  
1x Frame  
1x Weight & chain  
1x Square fitting blade - 50mm depth  
1x Round fitting blade - 40mm depth

ES-230-00 Complete Set - Extended  
Consisting of:  
1x Frame  
1x Weight & chain  
3x Square fitting blades: 3x Round fitting blades:  
50mm depth 40mm depth  
75mm depth 75mm depth  
100mm depth 100mm depth



Weight & chain  
ES-230-07





Double Bent Hohmann Retractors  
Single Prong  
Blade width 15mm

11.25" length  
Blade and tip length 3.5"

ES-266-11 (A)

10.50" length  
Blade and tip length 2.5"

ES-267-10 (B)



Double Bent Hohmann Retractors  
Single & Double Prong, Long  
Blade width 15mm

12.50" length  
Blade and tip length 3"  
ES-268-12 (A)

12.50" length  
Blade and tip length 3"  
ES-269-12 (B)

12.50" length  
Blade and tip length 3"  
ES-270-12 (C)

13.75" length  
Blade and tip length 5"  
ES-271-13 (D)

12.50" length  
Blade and tip length 3"  
ES-271-13 (E)



(C) EXTRA GRIP TIP  
Serrated Blade with extra grip,  
helps to stabilize the retractor  
around the bone.

Double Bent Hohmann Retractors  
Single Prong, Extra Long  
Blade width 15mm

18" length  
Blade and tip length 5"  
ES-273-18 (A)

16.25" length  
Blade and tip length 3"  
ES-274-16 (B)



APC Hip Retractor Series

14" length  
Blade width 22mm Single Prong  
ES-276-14

(A)

14" length  
Blade width 24mm Double Prong, Standard  
ES-278-14

(B)

14" length  
Double Prong, wide  
ES-280-14

(C)

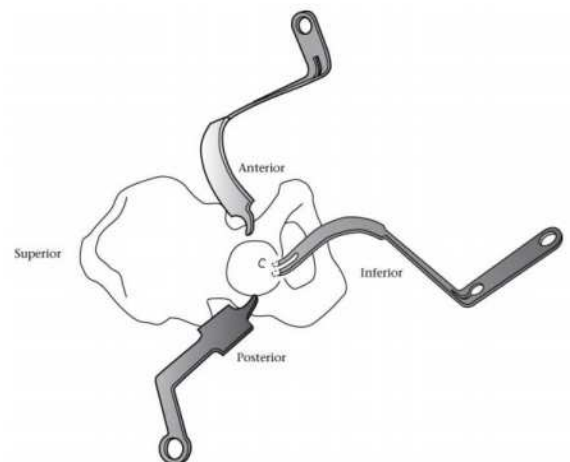
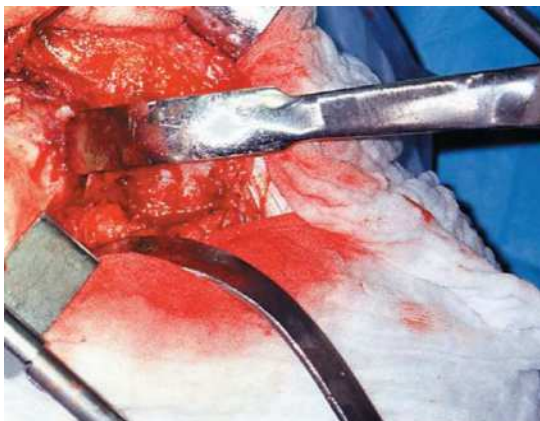

Goligher Retractor  
Abdominal Self-Retaining Retractor



Frame only  
ES-235-01

2 Central Blades

90mm deep x 90mm wide  
ES-235-90 (A)

55mm deep x 90mm wide  
ES-235-90 (B)

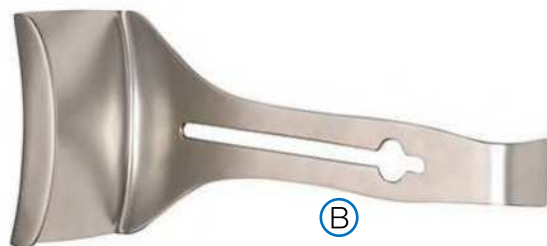

ES-236-90 Complete Set - Basic

Consisting of:

- 1x Frame
- 2x Set of Lateral Blades (ES-236-90), (ES-236-50)
- 2x Central blades (ES-235-90), (ES-235-55)

2 Sets of Lateral Blades

90mm deep x 50mm wide  
ES-236-90 (C)

50mm deep x 30mm wide  
ES-236-50 (D)



Wests S/R Retractor  
14cm/5½" length  
3 x4 Sharp prongs

ES-236-14

Weitlaner S/R Retractor  
14cm/5½" length  
3 x4 Blunt prongs

ES-237-14

Weitlaner S/R Retractor  
14cm/5½" length  
3x4 Semi Sharp prongs

ES-238-14



Travers S/R Retractor  
20cm/8" length  
4 x 5 Blunt prongs

ES-240-20



Norfolk and Norwich S/R Retractor  
22cm//8¾" length  
4x5 Blunt prongs

ES-740-22



Gelpi Laminectomy Retractor  
Sharp prongs

	Length	Prong depth
ES-244-18	18.5cm/7¼"	30mm
ES-244-19	19.5cm/7¾"	50mm
ES581GN	30cm/11¾"	70mm
ES582GN	30cm/11¾"	100mm



Mollison S/R Retractor  
15.5cm/6" length  
4x4 Sharp prongs

ES-754-15



Mollison S/R Retractor  
14cm/5½" length, Curved  
2x2 Sharp prongs

ES-754-16



**Charnley Vertical Retractor**

24.5cm/9½" length  
3 x 4 Sharp prongs  
Blade depth 22mm

ES4007-24



**Cones Self Retaining Retractor**

3x4 Prongs  
Jointed arms



Blunt Prongs	Length	Depth	Sharp Prongs	Length	Depth
ES4064- 13	13cm/5"	15mm	ES4063- 13	13cm/5"	15mm
ES4066- 16	16cm/6½"	15mm	ES4065-16	16cm/6½"	15mm
ES4068- 20	20cm/8"	20mm	ES4067-20	20cm/8"	20mm
ES4070- 24	24cm/9½"	25mm	ES4069-24	24cm/9½"	25mm

**Harvey Jackson Self Retaining Retractor**

30.5cm/12" length  
Blade depth 45mm  
3X Sharp prongs

ES401

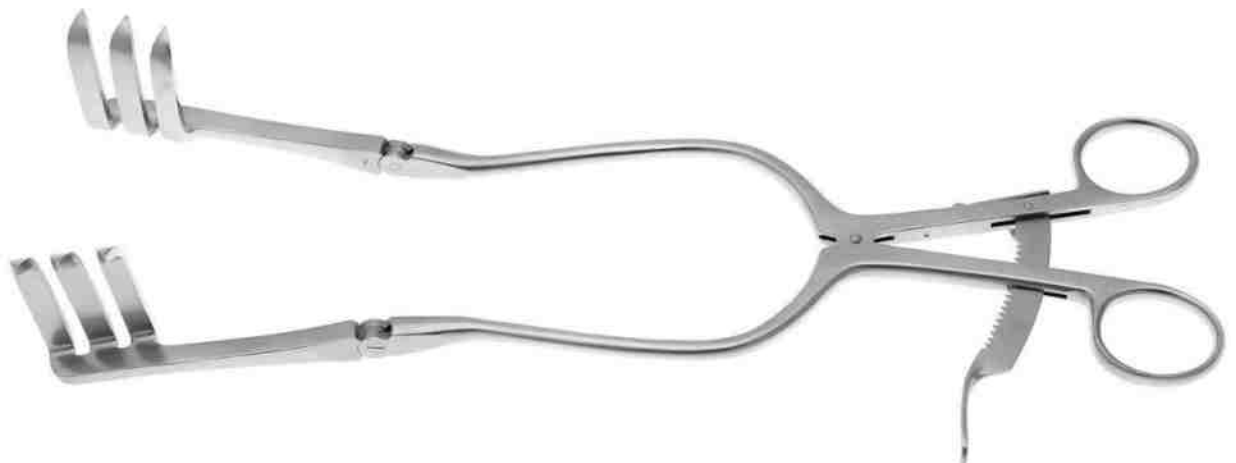

**Charnley Horizontal Hip Retractor**

28cm/11" length  
Blade depth 18mm  
Hinged joint  
7" opening

ES4006-28

To retract the detached trochanter headwards, and the femur towards the feet



**Hardinge Horizontal Retractor**

Blade depth 18mm  
Hinged joint

ES4007-28



**Charnley Pin Retractor**

Complete set with:  
T-handle introducer  
Pair of pins with chains

ES1100-00

ES11ES-00 T-handle only



ES1102-00 Pair of pins with chain only

Viper Hinged Scoliosis Retractor  
30cm/11¾" length  
Sharp

Depth Prongs

ES724 8-38H	40mm
ES7248-40H	70mm
ES7248-50H	100mm

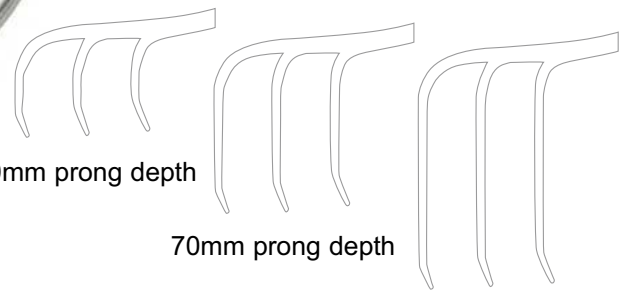
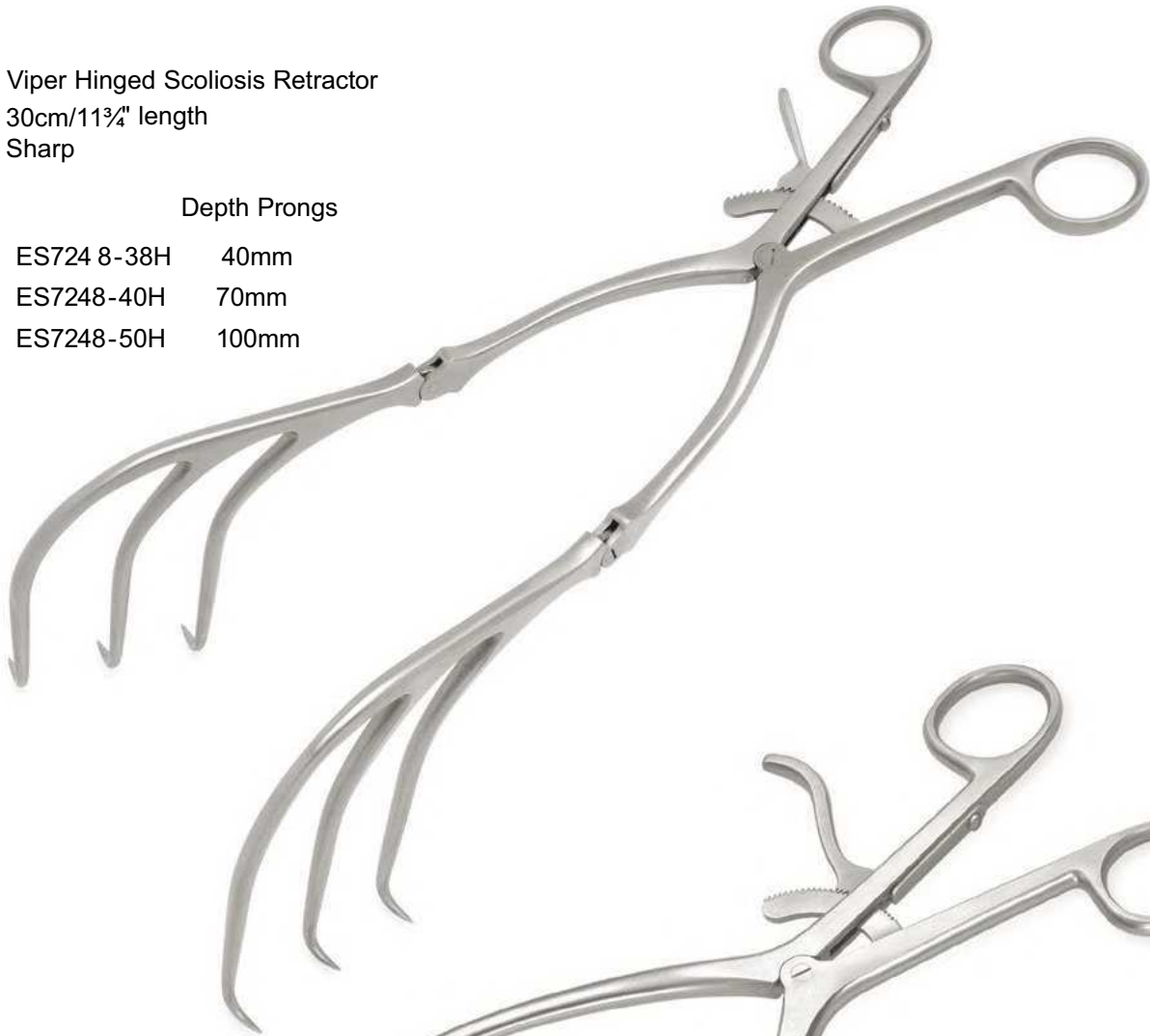

40mm prong depth

70mm prong depth

100mm prong depth

Viper Scoliosis Retractor  
30cm/11¾" length  
Sharp prongs

Depth Prongs

ES724 8-38	40mm
ES724 8-40	70mm
ES724 8-50	100mm





SECTION  
03

BONE HOLDING FORCEPS & CLAMPS

Langenbeck Bone Holding Forceps  
20cm/8" length

ES-808-20

5mm



Frosch Bone Holding Forceps  
18cm/7" length

Toothed/serrated jaws

ES-806-18



St. Thomas Bone Holding Forceps  
18cm/7" length  
Screw joint

ES-805-18



Fergusson Bone Holding Forceps  
21 cm/8¼" length  
Screw joint

ES-804-21



Langenbeck Bone Holding Forceps  
21 cm/8¼" length

ES-802-21



Trochanter Holding Forceps  
21 cm/9" length  
ES-803-21



Hey Groves Bone Holding Forceps  
Screw joints  
Serrated jaws



	Length	
ES-834-27	21cm/9"	Small
ES-834-30	27cm/10¾"	Medium
ES-834-21	30.5cm/12"	Large

Verbrugge Bone Holding Forceps  
17.5cm/9" length  
ES-837-17

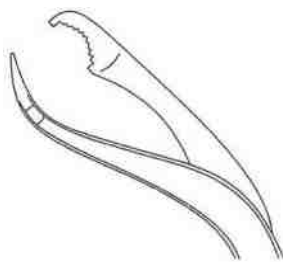

Verbrugge Bone Holding Forceps

	Length	
ES-835-03	27cm/10¾"	Large
ES-835-02	26cm/10¼"	Medium
ES-835-01	25cm/10"	Small



Verbrugge  
Self-Centering Forceps with thread fixation



2.5mm



ES-829-15  
15cm/6" length

6.5mm



ES-829-19  
19cm/7½" length

9.5mm



ES-829-24  
24cm/9½" length

10mm



ES-829-26  
26cm/10¼" length

11mm



ES-829-28  
28cm/11" length

Semb  
19cm/7½" length  
Lateral Curved, with ratchet

ES-828-19

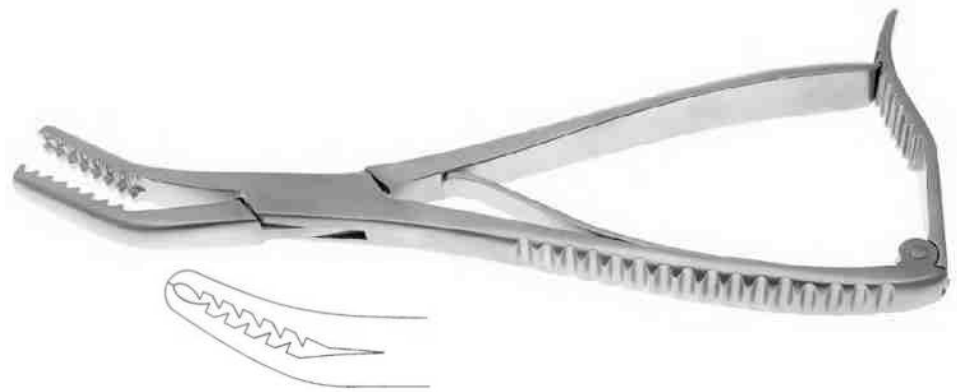

Semb  
19cm/7½" length  
Angled to side

ES-829-19



Lane  
With Ratchet

ES-832-33 Length 33cm/13"  
ES-832-45 Length 45cm/17¾"

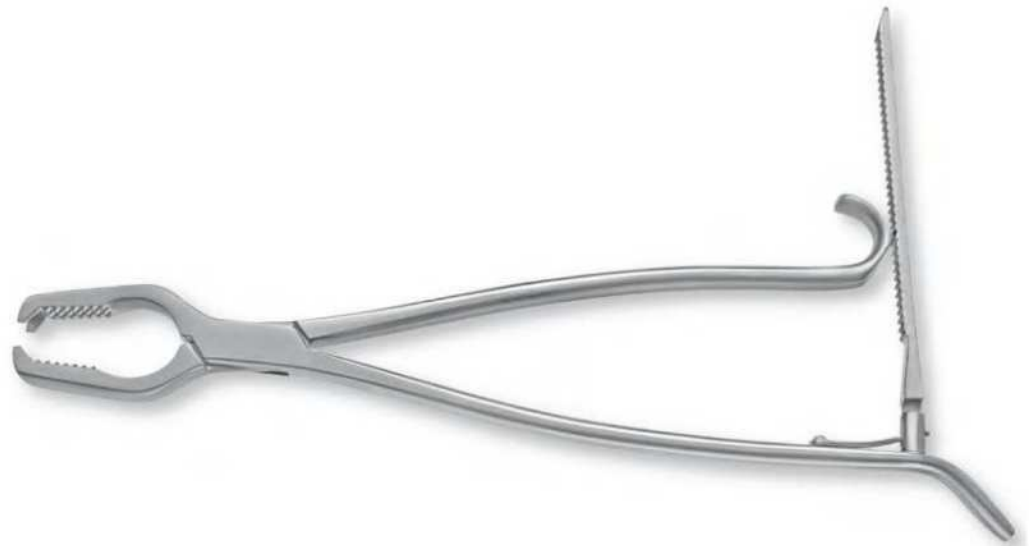

Lane  
Without Ratchet

ES-830-33 Length 33cm/13"  
ES-830-45 Length 45cm/17¾"



Kern  
Without ratchet

	Length
ES-810-21	15cm/6"
ES-810-17	17cm/6¾"
ES-810-15	21cm/8¼"



Kern  
With Ratchet

	Length
ES-812-15	15cm/6"
ES-812-17	17cm/6¾"
ES-812-21	21cm/8¼"



Lambotte  
With movable jaw

	Length
ES-817-21	21cm/8¼"
ES-817-26	26cm/10¼"
ES-817-33	33cm/13"



Lambotte  
With movable jaw

	Length
ES-819-19	19cm/7½"
ES-819-23	23cm/6¾"
ES-819-26	26cm/10¼"



Farabeuf-Lambotte  
26cm/10¼" length

ES-822-26



Farabeuf-Lambotte  
26cm/10¼" length

ES-823-26



Ferabeuf

Length  
ES-825-26 26cm/10¼"  
ES-825-23 23cm/6¾"



Lambotte  
With movable jaw

Length  
ES-824-30 30cm/12"  
ES-824-27 27cm/10¾"  
ES-824-22 22cm/8¾"



Ulrich  
Straight



Fig.1

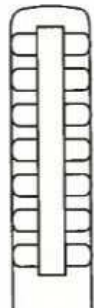

Fig.2

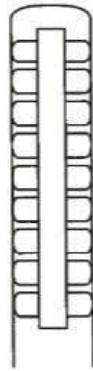

Fig.3

	Length	
ES-826-28	28cm/11"	Fig.3
ES-826-25	25cm/9¾"	Fig.2
ES-826-23	23cm/6¾"	Fig.1

Ulrich  
Laterally Angled



Fig.1

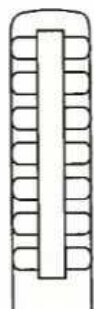

Fig.2

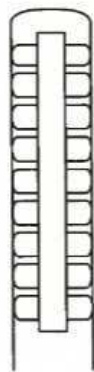
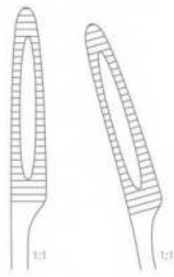

Fig.3

	Length	
ES-827-23	23cm/6¾"	Fig.1
ES-827-25	25cm/9¾"	Fig.2
ES-827-28	28cm/11"	Fig.3



Sequestrum  
20cm/8" length



ES-776-20 ES-777-20



Patella  
18cm/7" length

ES-774-18



Cartilage  
14cm/7" length  
Curved

ES-784-14

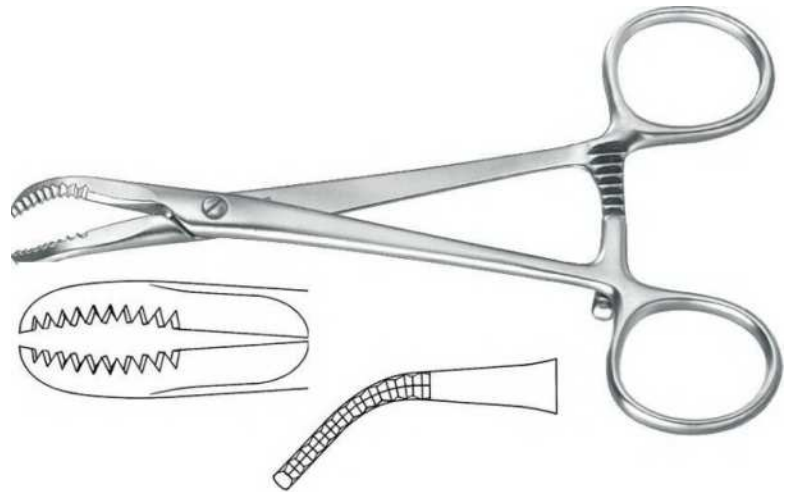

Van Buren  
23cm/9" length

ES-778-23



Reposition Forceps  
9.5cm/3¾" length

ES-800-09



Reposition Forceps  
13.5cm/5¼" length

ES-801-13  
For maxillary reposition



Steinhauser Reposition Forceps  
13.5cm/5¼" length

ES-793-13

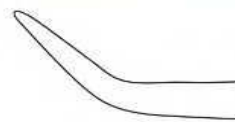

Bone Holding Forceps  
12cm/4¾" length

ES-796-12

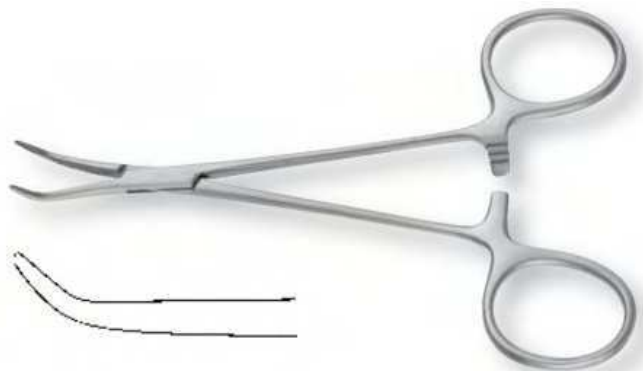

Reposition Forceps

12cm/4¾" length  
Bone Fragment Clamp

ES-791-12



Bone Holding Forceps  
14.5cm/5¾" length  
With guide for K-wire

ES-797-11 1.1mm  
ES-797-13 1.3mm  
ES-797-16 1.6mm



Stagbeetle Reposition Forceps  
12 cm/4¾" length  
Curved, Fine Tips

ES-798-12

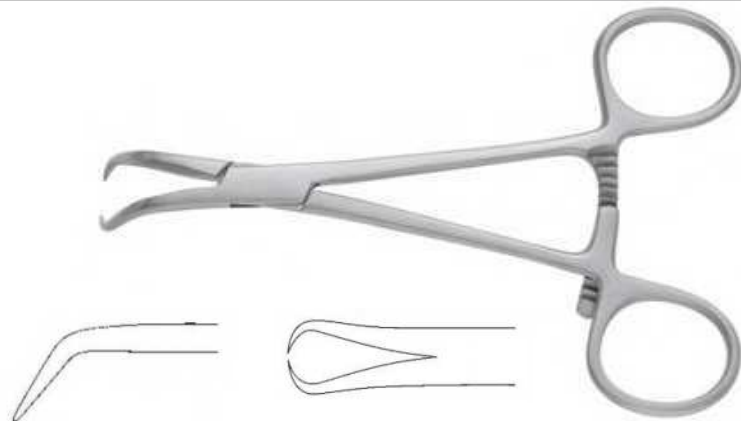

Reil Reduction Forceps  
20cm/8" length

ES-770-19

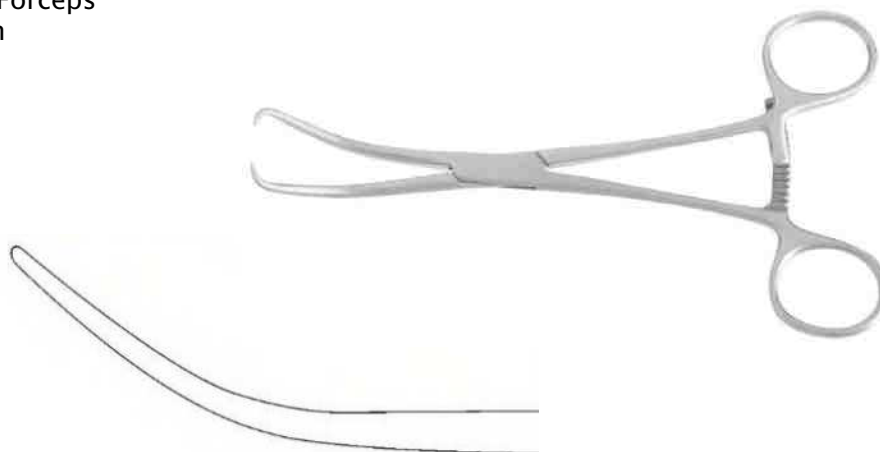

Reposition Forceps  
20cm/8" length

ES-770-20



Meyer

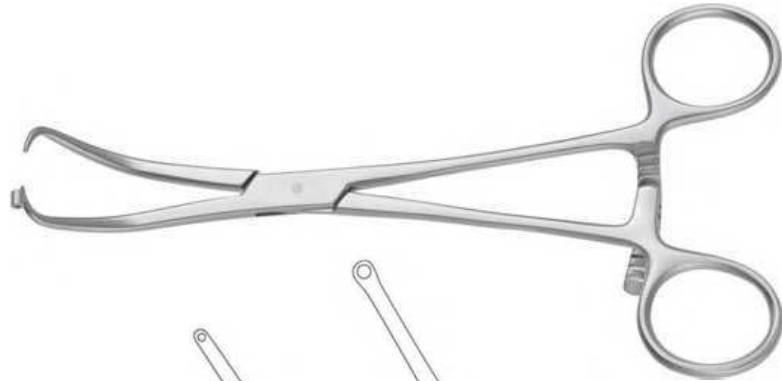

For K-wire Length

ES-772-17	1.0mm	17cm//6¾"
ES-772-20	2.0mm	20.5cm/8"

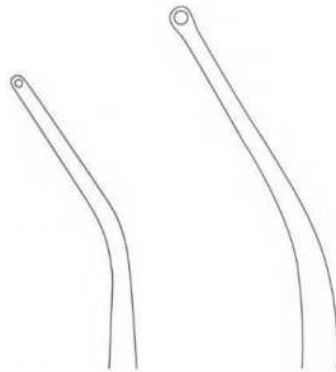

Bankart  
17cm/6¾" length  
Perforating Forceps

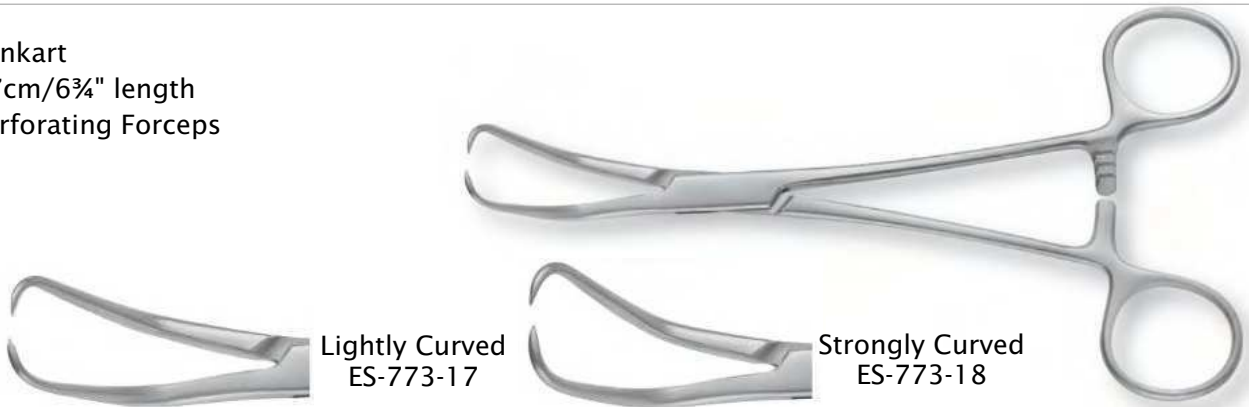

Lightly Curved  
ES-773-17

Strongly Curved  
ES-773-18

Lewin  
17.5cm/6¾" length  
Serrated, Slightly Curved

ES-792-17



Pelvic Reduction Forceps  
19cm/7½" length  
Angled, small  
Pointed ball tips  
Speed lock

ES-839-01



Pelvic Reduction Forceps  
24.5cm/9½" length  
Angled, large  
Pointed ball tips  
Speed lock

ES-839-02



Pelvic Reduction Forceps  
25cm/10" length  
Straight, large  
Pointed ball tips  
Speed lock

ES-839-03



Pelvic Reduction Forceps  
40.5cm/16½" length  
Pointed ball tips  
Speed lock

ES-839-06



Pelvic Reduction Forceps  
34.5cm/14" length  
With quick lock

ES-839-07



Ball Spike  
30.5cm/9½" length

ES-839-08



Pelvic Reduction Forceps  
41cm/16" length  
Pointed ball tips  
Speed lock

ES-839-05



Pelvic Reduction Forceps  
40cm/16" length  
3 pointed ball tips  
Speed lock

ES-839-04



Lowmann  
Bone Holding Clamp  
1x1 Teeth



	Length
ES-861-13	13cm/5"
ES-861-18	18.5cm/7¼"
ES-861-20	20cm/8"

Lowmann  
Bone Holding Clamp  
1x2 Teeth



	Length
ES-177-18	18cm/7"
ES-177-20	20cm/8"
ES-177-22	22cm/8¾"
ES-177-12	12cm/4¾"

Lambart Lowmann  
Bone Holding Clamp  
2x2 Teeth



	Length
ES-179-18	18cm/7"
ES-179-20	20cm/8"
ES-179-22	22cm/8¾"



Lowmann-Hoglund  
Bone Holding Clamp, Rotatable  
2x2 Teeth



	Length
ES-178-18	18cm/7"
ES-178-20	20cm/8"
ES-178-22	22cm/8¾"

Gerster  
Traction Bar

9cm/3½" length

ES-178-09





SECTION

04

TENDON GRASPING FORCEPS

Smillie  
14cm/5½" length

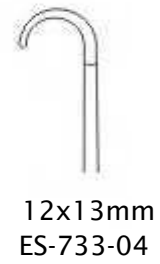
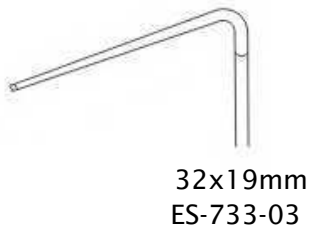

Larsen  
Grasping Forceps  
10cm/4" length



Herz  
Grasping Forceps  
15.5cm/6" length

ES-764-01  
ES-764-02

Serration  
Fine  
Coarse

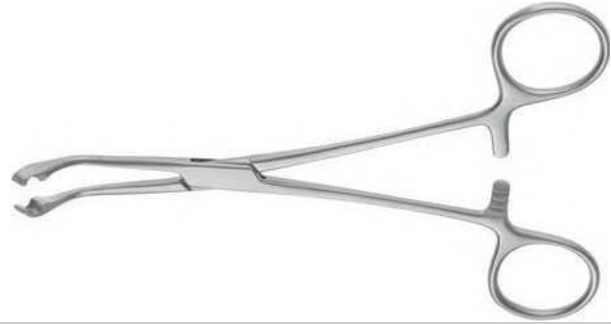

Halsted-Mosquito  
15cm/6" length  
Grasping Forceps



Englert  
4x5 Atraumatic Teeth  
14.5cm/5¾" length

ES-761-15



Ombredanne (Iselin)  
16cm/6¼" length  
4x5 Teeth

ES-870-16



Tendon Interlacing  
15cm/6" length

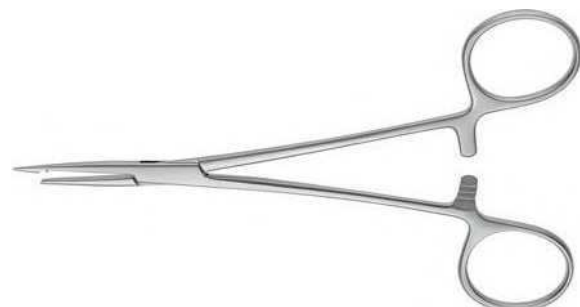

Tendon Seizing Forceps  
With 3 Pins  
13cm/5" length

ES-766-13



Steinmann  
Seizing Forceps  
16cm/6¼" length

ES-758-16

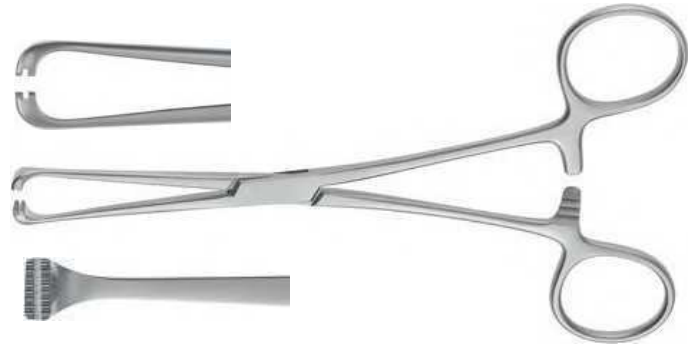

Carroll  
11cm/4½" length  
Tendon Forceps, Curved

ES-765-11



Hoer  
Tendon Grasping Forceps  
12cm/4¾" length  
1x2 teeth

ES-765-11



Anderson  
Brand Tendon Retriever, Light Model  
20.5cm/8" length

ES-759-20



Brand  
Tendon Seizing Forceps

	Length
ES-760-15	15cm/6"
ES-760-19	19cm/7½"
ES-760-24	24cm/9½"



Brand  
Tendon Seizing Forceps,  
Curved

ES-761-25 length  
25cm/10"



Tendon Tunnelling Forceps  
20.5cm/8" length

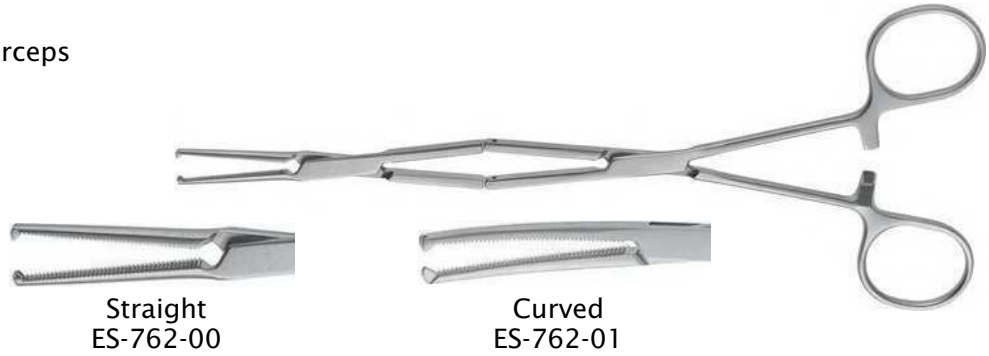

Straight  
ES-762-00

Curved  
ES-762-01

Kleinert-Kutz  
Tendon Seizing Forceps,  
1x2 Teeth  
Flexible, 1x8mm serrated Jaws  
20cm/8" length

ES-767-20

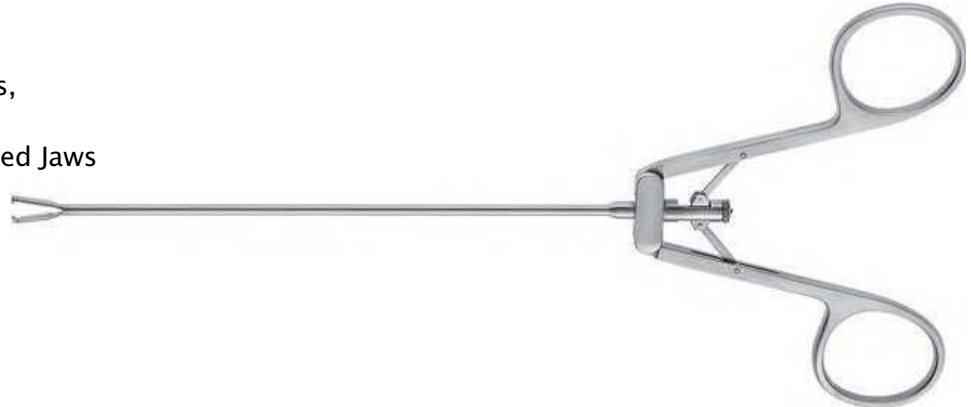

Bunnell  
Probe, Malleable  
23cm/9" length

ES-754-23







Dietrich  
Tendon Fixation Needle, 1.7mm  
45mm/1¾" length

ES-755-45



Bunnell  
Tendon Stripper  
15cm/6" length



ES-744-01	2.5mm	Fig.1	
ES-744-02	3.0mm	Fig.2	
ES-744-03	4.0mm	Fig.3	
ES-744-04	5.0mm	Fig.4	
ES-744-05	6.5mm	Fig.5	

Tendon Tunnel Instrument  
With obturating screw  
33.5cm/133/4" length

ES-748-00



Screw Only  
ES-748-01

Tendon Stripper  
28cm/11" length

ES-752-28



Fischer  
Tendon Stripper, Blunt  
Ferozell Handle  
31cm/1272" length

ES-750-31

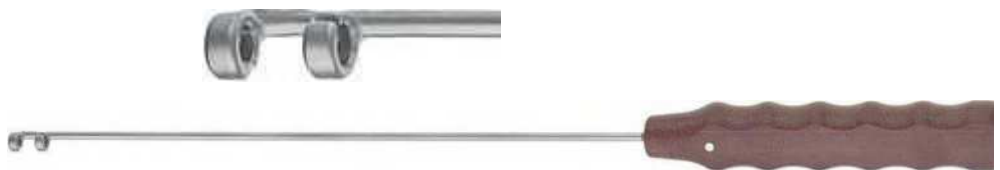

Tendon Stripper  
23cm/9" length



		
4mm ES-746-40	4.5mm ES-746-45	5.5mm ES-746-55

**Bunnell  
Tendon Stripper**



3mm inner			4mm inner		
	with slot	Length		with slot	Length
ES-870-28	ES-871-28	28.5cm/11"	ES-874-28	ES-875-28	28.5cm/11"
ES-870-35	ES-871-35	35cm/133/4	ES-874-35	ES-875-35	35cm/133/4
ES-870-60	ES-871-60	60cm/24"	ES-874-60	ES-875-60	60cm/24"

5mm inner			6mm inner		
	with slot	Length		with slot	Length
ES-878-28	ES-879-28	28.5cm/11"	ES-880-28	ES-881-28	28.5cm/11"
ES-878-35	ES-879-35	35cm/1334	ES-880-35	ES-881-35	35cm/1334
ES-878-60	ES-879-60	60cm/24"	ES-880-60	ES-881-60	60cm/24"

**Paul  
Tendon Retractor, Blunt  
3 Prongs  
12.5cm/43/4" length  
ES-886-12**



**Klapp  
Tendon Retractor, Blunt  
3 Prongs  
17.5cm/7" length**



2 Prongs  
ES-888-02



3 Prongs  
ES-888-03



4 Prongs  
ES-888-04

**Strandell-Stille  
Tendon Retractor  
15x6mm  
19cm/71/2" length**



Toothed  
ES-890-19



Blunt  
ES-891-19



Stevens  
Tenotomy Scissors

Sharp

Straight	Curved	Length
ES-900-10	ES-901-10	10.5cm/4 1/4"
ES-901-11	ES-901-11	11.5cm/4 1/2"

Blunt

Straight	Curved	Length
ES-903-10	ES-904-10	10.5cm/4 1/4"
ES-904-11	ES-904-11	11.5cm/4 1/2"



Martin  
Cartilage Scissors  
Curved  
20cm/8" length

ES-906-20



Martin  
Cartilage Scissors  
SuperCut  
20cm/8" length

ES-907-20



Resano  
Capsule Scissors, Angled  
Sharp/Blunt  
25cm/9 1/2" length

ES-908-25



Martin  
Cartilage Holding Forceps  
19cm/7 1/2" length  
ES-788-19



Bircher-Ganske  
Cartilage Holding  
Forceps  
20cm/8" length



Bircher-Ganske  
Cartilage Holding Forceps  
20cm/8" length  
ES-783-20



Dingmann  
Cartilage Holding Forceps  
19cm/7 1/2" length  
ES-785-19



Dingmann Mod.  
19cm/7 1/2" length  
ES-787-19



Walton  
Cartilage Forceps  
Slightly curved with pins  
18.5cm/7 1/2" length  
ES-789-18

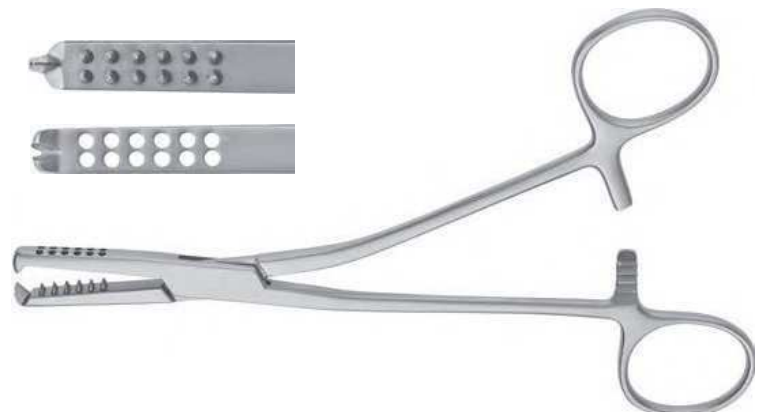

Downing  
Cartilage Knife  
25.5cm/10" length  
ES-790-25



Maniscotome  
Double Edge  
18cm/7" length



Straight  
ES-735-18

Slightly Curved  
ES-736-18

Neff  
Maniscotome  
22cm/83/4" length  
ES-906-20



Curved Right  
ES-737-22

Curved Left  
ES-739-22

Bircher  
Maniscotome  
19cm/71/2" length



Straight  
ES-725-19



Curved  
ES-738-19

Salenius  
Maniscotome  
22cm/83/4" length



Right Side  
ES-740-22



Left Side  
ES-741-22

Smille  
Maniscotome, Straight  
17cm/63/4" length

ES-730-17



Smille  
Maniscotome, with guards  
17cm/63/4" length

Right  
ES-731-17

Left  
ES-7ES-17



Lowe-Breck  
Maniscotome  
25cm/10" length

ES-734-25



Preston  
Maniscus Ligament Flavum Forceps  
Serrated Jaws, 1x2 Teeth  
19cm/71/2" length

ES-728-19

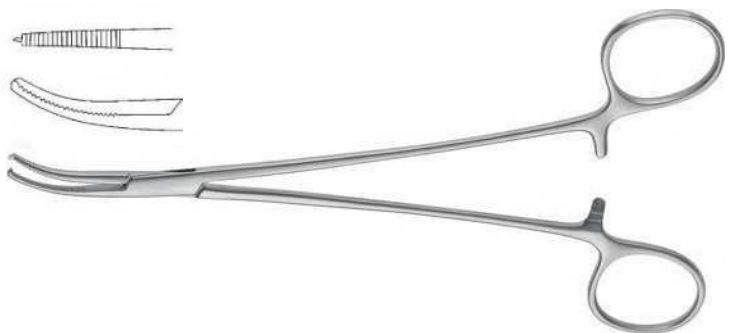

Bircher  
Maniscus Grasping Forceps  
20cm/73/4" length

ES-729-20





SECTION  
05

BONE CURETTES

Williger Curette  
13.5cm/5 1/2" length  
Double curette



○ ○  
Fig. 00 - 0  
2.5/3.0mm  
ES-550-00

○ ○  
Fig. 1 - 2  
3.5/4.2mm  
ES-550-12

○ ○  
Fig. 1 - 2  
3.5/4.2mm  
ES-550-12

Martini Curette  
13.5cm/5 1/2" length  
Double curette



○ ○  
Fig. 00 - 0  
2.6/3.1mm  
ES-552-00

○ ○  
Fig. 0 - 1  
3.1/4.2mm  
ES-552-01

○ ○  
Fig. 1 - 2  
4.2/4.8mm  
ES-552-12

Jansen Curette  
16cm/6 1/4" length  
Double curette



○ ○  
3.0/4.0mm  
ES-556-16

Jansen Curette  
21cm/8 1/4" length  
Double curette



○ ○  
6.0/7.0mm  
ES-560-21

Jansen Curette  
15cm/6" length  
Double curette



○ ○  
3.0/4.0mm  
ES-557-15

Volkman Curette  
22cm/83/4" length  
Double ended



	Size	
ES-561-01	Small	2.5x4/5x8mm
ES-561-02	Medium	4x6/6x10mm
ES-561-03	Large	5x8/7x14mm

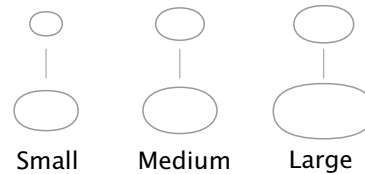

Volkman Curette  
Double curette

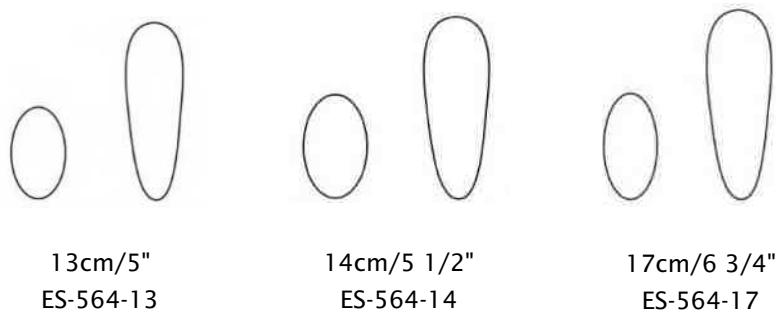

13cm/5"  
ES-564-13

14cm/5 1/2"  
ES-564-14

17cm/6 3/4"  
ES-564-17

Volkman Curette  
Double curette

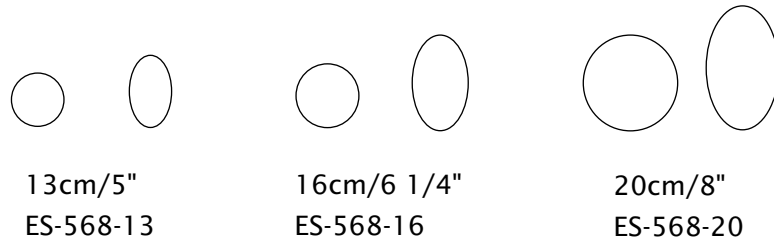

13cm/5"  
ES-568-13

16cm/6 1/4"  
ES-568-16

20cm/8"  
ES-568-20

Jacobson Curette  
14cm/5 1/2" length  
Double curette



ES-558-14

Hemingway Curette  
16.5cm/6 1/2" length  
Double curette

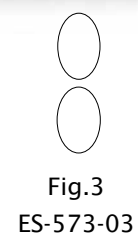
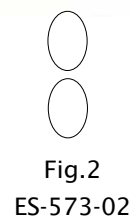
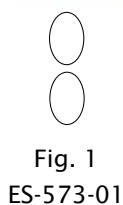

House  
15.5cm/6" length  
Straight  
1.4x1.8mm / 2x2.5mm



ES-570-15

House  
15.5cm/6" length  
Angled, 45°  
1.4x1.8mm / 2x2.5mm



ES-571-15

Lucas  
16.5cm/6 1/2" length



ES-571-15



Fig. 1  
ES-574-01

Fig.2  
ES-574-02

Fig.3  
ES-574-03



Barth Curette  
18cm/7" length  
Double curette



ES-569-18



**Meyerhoefer  
Chalazion Curette**  
13cm/5 1/4" length



- Fig. 000/0.5mm  
ES-575-30
- Fig. 00/1.0mm  
ES-575-20
- Fig. 0/1.5mm  
ES-575-10
- Fig. 1/1.8mm  
ES-575-01
- Fig. 2/2.0mm  
ES-575-02
- Fig. 3/2.5mm  
ES-575-03
- Fig. 4/3.5mm  
ES-575-04
- Fig. 5/4.0mm  
ES-575-05
- Fig. 6/4.5mm  
ES-575-06

**Meyerhoefer  
Curette**  
14cm/5 1/2" length



- Fig.0 /2.0mm  
ES-576-10
- Fig. 1/2.5mm  
ES-576-01
- Fig. 2/3.0mm  
ES-576-02
- Fig. 3/3.5mm  
ES-576-03
- Fig. 4/5.0mm  
ES-576-04

**Mannrefelt  
Curette**  
15cm/6" length







4mm  
ES-577-40



7mm  
ES-577-70



9mm  
ES-577-90

**Williger Curette**  
16cm/6 1/4" length  
Double Curette







Fig.00  
ES-572-01



Fig.0  
ES-572-02



Fig. 1  
ES-572-03

Luxation Lever  
31cm/12 1/4" length  
Tufnol Handle  
25mm wide

ES-430-25



Bone Curette  
Tufnol handle

Large cup 27mm Ø  
ES-432-32  
32cm/12 3/4" length

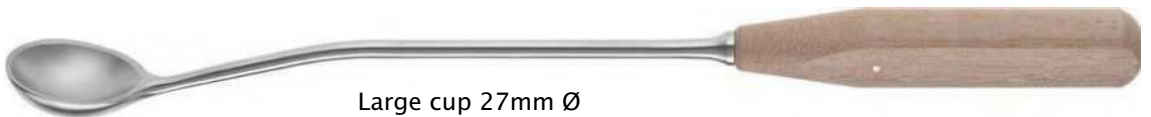

Medium cup 13mm Ø  
ES-432-27  
27cm/10 3/4" length



Small cup 9mm Ø  
ES-432-24  
24cm/9 1/2" length



Toothed Bone Curette  
27cm/10 3/4" length  
Sharp spoon with teeth  
Tufnol handle

Small cup 9mm Ø  
ES-435-09

Medium cup 15mm Ø  
ES-435-15



Toothed Bone Curette  
27cm/10 3/4" length  
Sharp spoon with teeth  
Double Angled, 9mm  
Tufnol handle

ES-438-27



Kraemer Curette  
25cm/10" length  
Ring Curette  
Sharpened, Double Sided

	Size
ES-440-04	4mm
ES-440-05	5mm
ES-440-06	6mm



Cone  
27cm/93/4" length  
Ring Curette

Straight	Angled	Size
ES-443-03	ES-442-03	3.0mm Fig.3
ES-443-02	ES-442-02	6.0mm Fig.2
ES-443-01	ES-442-01	8.0mm Fig. 1



Straight



Angled

Caspar  
22cm/83/4" length  
Bone Scoop, Curved, Toothed  
Tufnol handle

	Size
ES-446-04	4mm
ES-446-05	5mm
ES-446-06	6mm



Charnley Bone Curette  
37cm/15" length  
T-handle

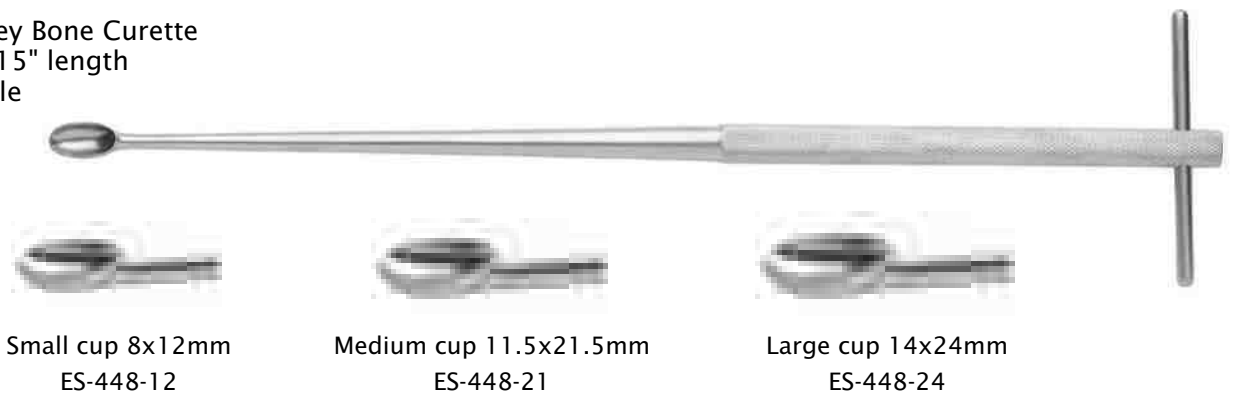

Charnley Ring Curette  
37cm/15" length Serrated cutting edge  
Double sided T-handle

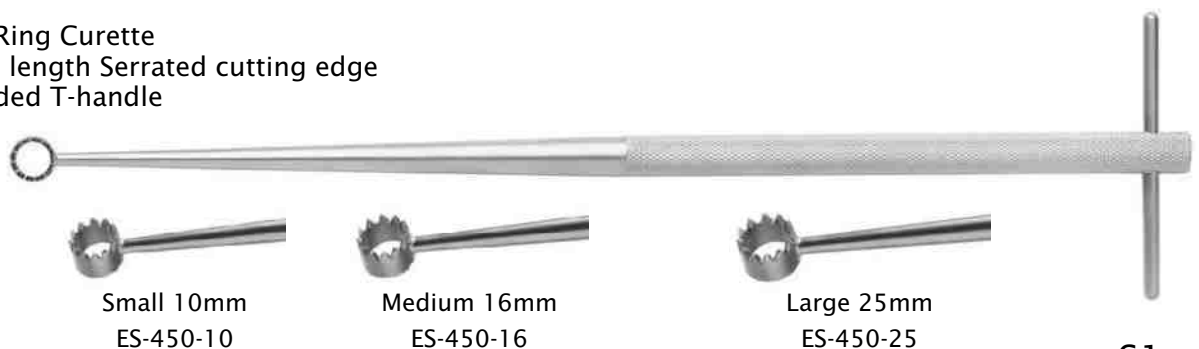

Volkman Curette  
28cm/11" length  
Handle from Artificial wood

Volkman Curette  
17cm/634" length  
Handle from artificial wood

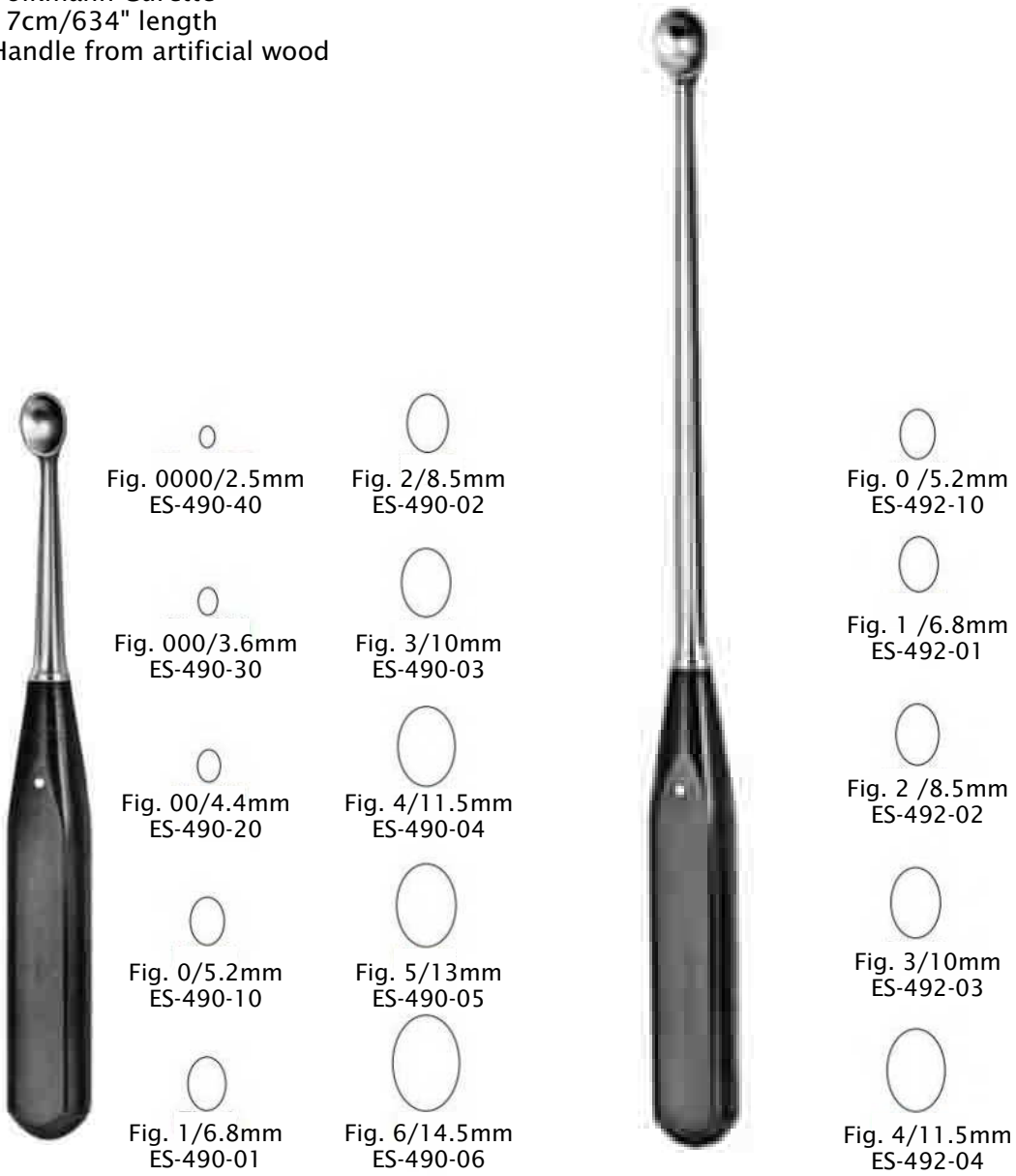

Caspar Curette  
22cm/83/4" length  
Handle from artificial wood  
Straight

Caspar Curette  
22cm/83/4" length  
Handle from Artificial wood  
Angled



○  
Fig. 000  
3.6mm  
ES-456-30

○  
Fig. 00  
4.4mm  
ES-456-20

○  
Fig. 0  
5.2mm  
ES-456-10



○  
Fig. 000  
3.6mm  
ES-457-30

○  
Fig. 00  
4.4mm  
ES-457-20

○  
Fig. 0  
5.2mm  
ES-457-10

Volkmann Curette  
17cm/63/4" length

Schede Curette  
17cm/634" length



Fig. 0000/2.5mm  
ES-502-40

Fig. 000/3.6mm  
ES-502-30

Fig. 00/4.4mm  
ES-502-20

Fig. 0/5.2mm  
ES-502-10

Fig. 1/6.8mm  
ES-503-01

Fig. 2/8.5mm  
ES-503-02

Fig. 3/10mm  
ES-503-03

Fig. 4/11.5mm  
ES-503-04

Fig. 5/13mm  
ES-503-05

Fig. 6 /14.5mm  
ES-503-06

Fig. 000/3.6mm  
ES-500-30

Fig. 00/4.4mm  
ES-500-20

Fig. 0/5.2mm  
ES-500-10

Fig. 1/6.8mm  
ES-501-01

Fig. 2/8.5mm  
ES-501-02

Fig. 3/10mm  
ES-501-03

Fig. 4/11.5mm  
ES-501-04

**Brunns Curette**  
17cm/63/4" length

**Spratt Curette**  
17cm/63/4" length



○	○	○	○
Fig. 0000/2.8mm ES-504-40	Fig. 2/6mm ES-505-02	Fig. 0000/2.5mm ES-506-40	Fig. 2/4.8mm ES-507-02
○	○	○	○
Fig. 000/3.3mm ES-504-30	Fig. 3/7.2mm ES-505-03	Fig. 000/2.8mm ES-506-30	Fig. 3/5.6mm ES-507-03
○	○	○	○
Fig. 00/3.9mm ES-504-20	Fig. 4/8.2mm ES-505-04	Fig. 00/3.3mm ES-506 20	Fig. 4/6.1mm ES-507-04
○	○	○	○
Fig. 0/4.7mm ES-504-10	Fig. 5/9.8mm ES-505-05	Fig. 0/3.7mm ES-506-10	Fig. 5/6.7mm ES-507-05
○	○	○	○
Fig. 1/5.3mm ES-505-01	Fig. 6/12mm ES-505-06	Fig. 1/4.3mm ES-507-01	

**Brns Curette**  
27cm/1034" length  
With Tufnol Handle

**Brns Curette**  
23cm/9" length



○  
Fig. 000/3.2mm  
ES-587-30

○  
Fig. 000/3.2mm  
ES-584-30

○  
Fig. 00/3.4mm  
ES-587-20

○  
Fig. 00/3.4mm  
ES-584-20

○  
Fig. 0/3.7mm  
ES-587-10

○  
Fig. 0/3.7mm  
ES-584-10

○  
Fig. 1/4.7mm  
ES-587-01

○  
Fig. 1/4.7mm  
ES-584-01

○  
Fig. 2/5.7mm  
ES-587-02

○  
Fig. 2/5.7mm  
ES-584-02

○  
Fig. 3/7mm  
ES-587-03

○  
Fig. 3/7mm  
ES-584-03

○  
Fig. 4/7.9mm  
ES-587-04

○  
Fig. 4/7.9mm  
ES-584-04

○  
Fig. 5/8.9mm  
ES-587-05

○  
Fig. 5/8.9mm  
ES-584-05

○  
Fig. 6/10.2mm  
ES-587-06

○  
Fig. 6/10.2mm  
ES-584-06



Uffenorde Curette  
17cm/6" length

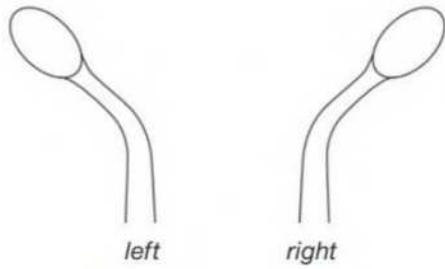

ES-599-01

ES-599-02

Left

Right



Siebenmann Curette  
16cm/6 1/4" length

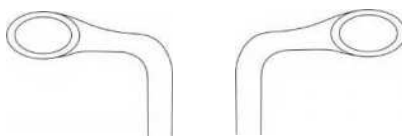

ES-599-01

ES-599-02



Williger Curette  
17.5cm/63/4" length



- |                             |                             |
|-----------------------------|-----------------------------|
| ○                           | ○                           |
| Fig. 00 /2.5mm<br>ES-510-20 | Fig. 00 /2.5mm<br>ES-512-20 |
| ○                           | ○                           |
| Fig. 0 /3.2mm<br>ES-510-10  | Fig. 0 /3.2mm<br>ES-512-10  |
| ○                           | ○                           |
| Fig. 1 /4mm<br>ES-512-01    | Fig. 1 /4mm<br>ES-512-01    |
| ○                           | ○                           |
| Fig. 2 /5.7mm<br>ES-512-02  | Fig. 2 /5.7mm<br>ES-512-02  |



















Halle Curette  
21cm/81/4" length



- |                            |
|----------------------------|
| ○                          |
| Fig. 1 /4.8mm<br>ES-548-01 |
| ○                          |
| Fig. 2 /5.8mm<br>ES-548-02 |
| ○                          |
| Fig. 3 /6.8mm<br>ES-548-03 |







Mod. USA Curette  
16cm/6 1/4" length



Straight	Left	Right
 Fig. 1 ES-542-01	 Fig. 1 ES-543-01	 Fig. 1 ES-545-01
 Fig. 2 ES-542-02	 Fig. 2 ES-543-02	 Fig. 2 ES-545-02
 Fig. 3 ES-542-03	 Fig. 3 ES-543-03	 Fig. 3 ES-545-03
 Fig. 4 ES-542-04	 Fig. 4 ES-543-04	 Fig. 4 ES-545-04
 Fig. 5 ES-542-05	 Fig. 5 ES-543-05	 Fig. 5 ES-545-05
 Fig. 6 ES-542-06	 Fig. 6 ES-543-06	 Fig. 6 ES-545-06









Simon Curette  
24cm/9 1/2" length



 Fig. 1 ES-540-01
 Fig. 2 ES-540-02
 Fig. 3 ES-540-03
 Fig. 4 ES-540-04
 Fig. 5 ES-540-05
 Fig. 6 ES-540-06









Hatfield Curette  
28cm/11" length



-   
ES-534-00  
3.0 x 5.0 mm
-   
ES-534-01  
3.5 x 5.5 mm
-   
ES-534-02  
4.5 x 6.4 mm
-   
ES-534-03  
5.0 x 8.0 mm
-   
ES-534-04  
5.0 x 8.0 mm
-   
ES-534-05  
7.0 x 11.0 mm
-   
ES-534-06  
8.5 x 12.5 mm
-   
ES-534-07  
9.5 x 14.5 mm
-   
ES-534-08  
10.5 x 16.8 mm









Hatfield Curette  
23cm/9" length



-   
ES-536-00  
3.0 x 5.0 mm
-   
ES-536-01  
3.5 x 5.5 mm
-   
ES-536-02  
4.5 x 6.4 mm
-   
ES-536-03  
5.0 x 8.0 mm
-   
ES-536-04  
6.0 x 9.0 mm
-   
ES-536-05  
7.0 x 11.0 mm
-   
ES-536-06  
8.5 x 12.5 mm
-   
ES-536-07  
9.5 x 14.5 mm
-   
ES-536-08  
10.5 x 16.8 mm

Cobb Curette  
28cm/11" length











-   
ES-538-00  
4.06 x 5.08 mm
-   
ES-538-01  
5.08 x 6.35 mm
-   
ES-538-02  
6.10 x 7.62mm
-   
ES-538-03  
7.11 x 8.89 mm
-   
ES-538-04  
8.13 x 10.16 mm
-   
ES-538-05  
9.14 x 11.43 mm
-   
ES-538-06  
10.16 x 12.70 mm
-   
ES-538-07  
11.18 x 13.97 mm
-   
ES-538-08  
12.19 x 15.24 mm

Volkman Curette  
25cm/10" length





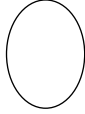

Straight jaw





				
Fig. 0000	Fig. 000	Fig. 00	Fig. 0	Fig. 1
ES-530-40	ES-530-30	ES-530-20	ES-530-10	ES-530-01

				
Fig. 2	Fig.3	Fig. 4	Fig. 5	Fig. 6
ES-530-02	ES-530-03	ES-530-04	ES-530-05	ES-530-06



Angled Jaw



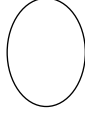







				
Fig. 0000	Fig. 000	Fig. 00	Fig. 0	Fig. 1
ES-531-40	ES-531-30	ES-531-20	ES-531-10	ES-531-01

				
Fig.3	Fig. 2	Fig. 4	Fig. 5	Fig. 6
ES-531-03	ES-531-02	ES-531-04	ES-531-05	ES-531-06

Volkman-Bruns Curette  
23cm/9" length













Straight jaw

				
Fig. 0000	Fig. 000	Fig. 00	Fig. O	Fig. 1
ES-532-40	ES-532-30	ES-532-20	ES-532-10	ES-532-01
3.0mm	3.3mm	3.9mm	4.7mm	5.3mm
				
Fig. 2	Fig.3	Fig. 4	Fig. 5	Fig. 6
ES-532-02	ES-532-03	ES-532-04	ES-532-05	ES-532-06
6.0mm	6.8mm	8.3mm	9.8mm	11.7mm



Angled Jaw

				
Fig. 0000	Fig. 000	Fig. 00	Fig. O	Fig. 1
ES-533-40	ES-533-30	ES-533-20	ES-533-10	ES-533-01
3.0mm	3.3mm	3.9mm	4.7mm	5.3mm
				
Fig. 2	Fig.3	Fig. 4	Fig. 5	Fig. 6
ES-533-02	ES-533-03	ES-533-04	ES-533-05	ES-533-06
6.0mm	6.8mm	8.3mm	9.8mm	11.7mm

Cloward Hibbs Spratt Curette  
Spinal Fusion  
22.5cm/9" length



Straight jaw

Fig. 000	Fig. 00	Fig. 0	Fig. 1	Fig. 2
ES-518-00	ES-519-00	ES-520-00	ES-522-01	ES-522-02
2x4mm	2.5x4.5mm	2.75x5.0mm	3x5.50mm	3.25x6mm

Fig. 3	Fig. 4	Fig. 5	Fig. 6
ES-522-03	ES-522-04	ES-522-05	ES-522-06
4x7mm	6x9.50mm	7x14mm	9x17mm



Angled Jaw

Fig. 000	Fig. 00	Fig. 0	Fig. 1	Fig. 2
ES-521-00	ES-523-00	ES-525-00	ES-525-01	ES-525-02
2x4mm	2.5x4.5mm	2.75x5.0mm	3x5.50mm	3.25x6mm

Fig. 3	Fig. 4	Fig. 5	Fig. 6
ES-525-03	ES-525-04	ES-525-05	ES-525-06
4x7mm	6x9.50mm	7x14mm	9x17mm

Scoville Curette  
25cm/10" length  
Bone Curette, 4mm

Daubenspeck Curette  
20cm/8" length

Bushe Curette  
25cm/10" length  
Bone Curette, 4mm

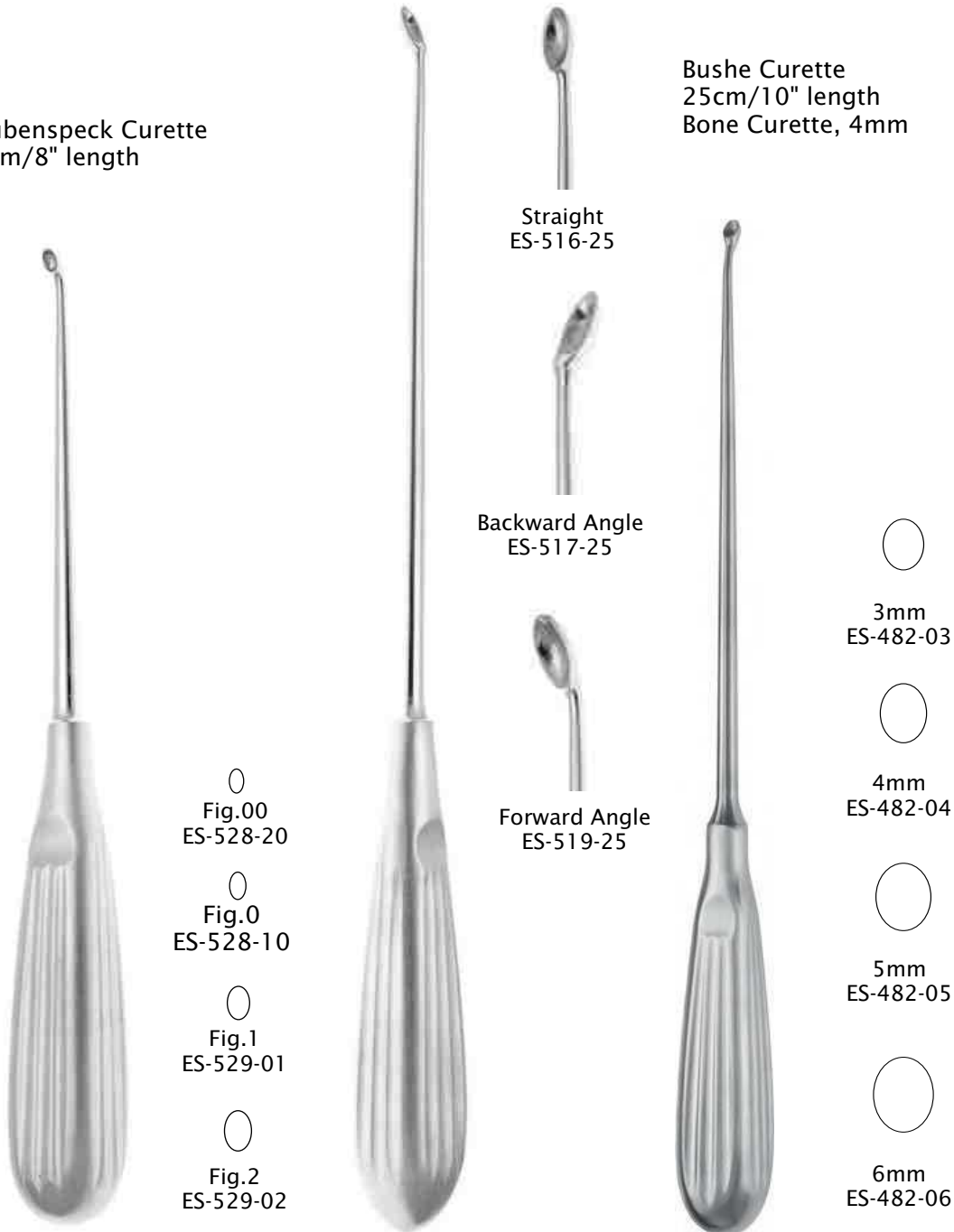



Zielke Curette  
Intervertebral  
Tufnol Handle



Straight		Length
Small	Large	
ES-490-21	ES-491-21	21cm/81/4"
ES-490-35	ES-491-35	35cm/133/4"
Angled		Length
Straight	Curved	
ES-492-25	ES-492-25	25cm/10"

Caspar Curette



  
27cm/103/4"  
ES-495-03  
3.0mm

  
27cm/103/4"  
ES-495-04  
4.0mm

  
25cm/10"  
ES-496-04  
4.0mm

  
25cm/10"  
ES-496-05  
5.0mm



SECTION

06

PERIOSTEAL ELEVATORS  
& RASPATORIES

**Adson Periosteal Elevator**  
17cm/63/4" length

	Width
A ES-650-17	9mm
B ES-651-17	4mm
C ES-652-17	6mm
D ES-653-17	7mm



**Alexander Periosteotome, 12mm**  
20cm/81/4" length

ES-634-20



**Lambotte Raspatory**  
21cm/81/4" length

	Width
ES-650-10	10mm
ES-650-15	15mm
ES-650-20	20mm
ES-650-25	25mm



**Farabeuf Rugine Elevator**  
15cm/6" length

Straight	Curved
ES-598-15	ES-599-15
12mm	12mm



\*illustrated

**Farabeuf Rugine Elevator with Hollow Handle**  
16cm/61/4" length

Straight	Curved
ES-658-16	ES-659-16
12mm	12mm



\*illustrated

Mcglamry  
21 cm/8 1/4" length

	Width
ES-626-09	9mm
ES-626-11	11mm
ES-626-15	15mm
ES-626-17	17mm



Crego  
Elevator, 7mm  
20cm/8" length

ES-618-20



Farabeuf-Collin  
Periosteal Raspatory  
15.5cm/6 1/4" length

Straight*	Curved
ES-582-15 11mm	ES-583-15 11mm



\* illustrated

Kraemer  
Raspatory, 10mm  
Round Blade  
18.5cm/7 1/4" length

ES-584-01



Kraemer  
Raspatory, 10mm  
Straight Blade  
18.5cm/7 1/4" length

ES-584-02



Martin Langenbeck

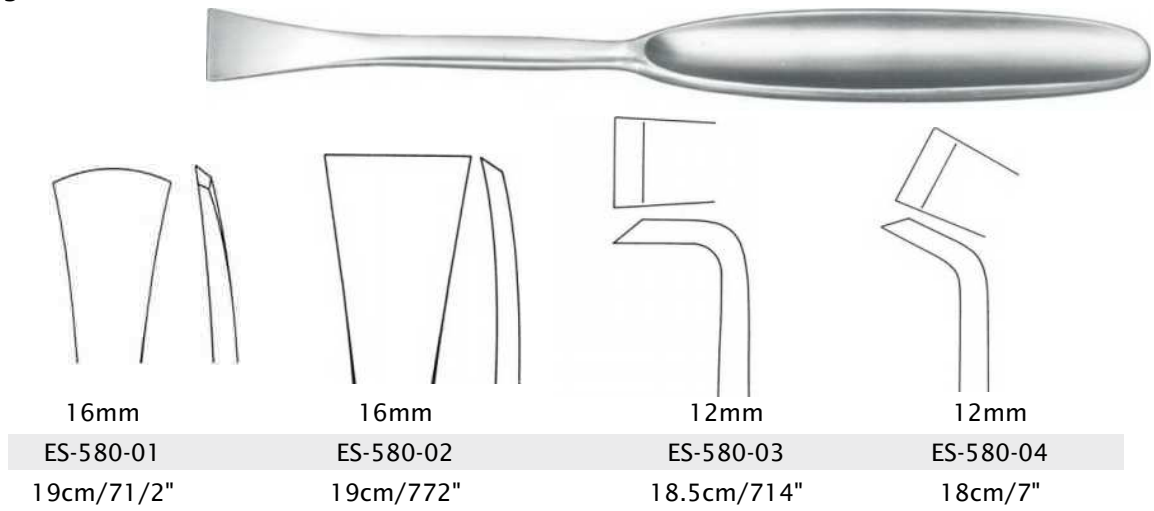

Martin Hoen



Martin Cushing



Martin Cushing  
17cm/63/4" length  
Raspatory, 8mm

ES-580-30

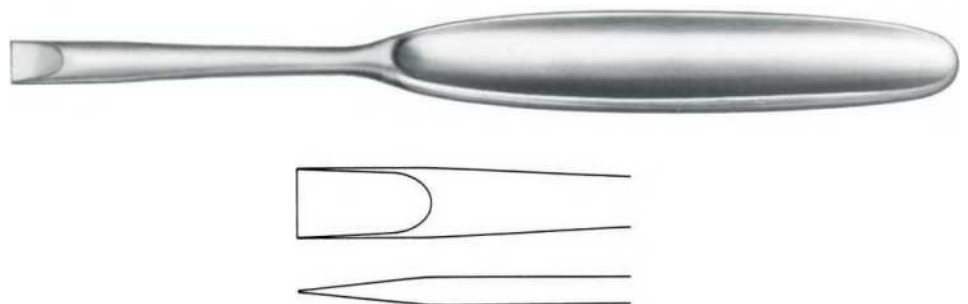

16cm/61/4" length

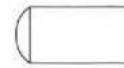

5mm  
ES-595-05

6mm  
ES-595-06

7mm  
ES-595-07

Vickers  
17cm/63/4" length

ES-677-17

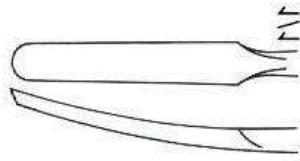

Vickers  
17cm/63/4" length

ES-679-17

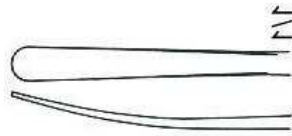

Cohen  
Double sided  
24cm/91/2" length

ES-688-24



McDonald  
Double sided  
19cm/71/2" length

ES-689-19



Alderdyce  
Double Sided  
21 cm/81/4" length

ES-687-21



Doyen  
Rib Raspatory  
17cm//6¾" length



Children,Left  
ES-619-17



Children,Right  
ES-620-17



Adult,Left  
ES-623-17



Adult, Right  
ES-625-17

Semb  
Raspatory with a hollow handle



Fig. 1

ES-632-01

17.5cm/7"

ES-630-01

18.5cm/7 1/4"



Fig. 2

ES-632-02

21cm/8 1/4"

ES-630-02

23cm/9"



Fig. 3

ES-632-03

17.5cm/7"

ES-630-03

18.5cm/7 1/4"



Fig. 4

ES-632-04

21cm/8 1/4"

ES-630-04

23cm/9"



Fig. 5

ES-632-05

20.5cm/8"

ES-630-05

21.5cm/8 1/2"



Langenbeck Elevator  
19cm/7 1/2" length

	Width
ES-657-01	8mm
ES-657-02	10mm



Martin-Langenbeck Elevator

	Length	Width
ES-667-01	17cm/6 3/4"	5mm
ES-667-02	17cm/6 3/4"	7mm
ES-667-03	20cm/8"	8mm
ES-667-04	20cm/8"	10mm



Williger (Blunt)

	Length
ES-661-17	17cm/6 3/4"
ES-663-16	16cm/6 1/4"



Cobb Elevator

	Length	Width
ES-670-01	28cm/11"	9.5mm
ES-670-02	28cm/11"	13mm
ES-670-03	28cm/11"	19mm
ES-670-04	28cm/11"	25mm
ES-670-05	28cm/11"	32mm



Sebilaeu  
17.5cm/7" length

ES-675-17	5mm
-----------	-----



Quervain  
20cm/8" length

ES-650-17      Width  
6mm



Cairns  
17.5cm/63/4" length  
Bone Flap Elevator

ES-654-16      Width  
5mm  
ES-655-16      7mm



Langenbeck Elevator  
23cm/9" length  
Curved, 11mm

ES-673-23



Sedillot Raspatory  
21 cm/81/4" length  
Sharp, 15mm

ES-597-21



Raspatory  
14cm/5½" length

ES-631-01



Raspatory  
14cm/5½" length

ES--631-02



Langenbeck  
18cm/7" length  
Periosteal Elevator, 14mm

ES-591-18



Langenbeck  
19cm/7½" length  
Raspatory, 16mm

ES-593-19



Jansen  
16.5cm/6½" length  
Periosteal Elevator

ES-593-16



Schneider  
17.5cm/7" length  
Raspatory, 13mm

ES-581-17



Schneider-Sauerbruch  
19cm/7½" length  
Raspatory, 13mm

ES-581-19



Williger Raspatory  
13cm/5" length



ES-637-13      Width  
5mm

Williger Raspatory  
16cm/6¼" length  
Bone Flap Elevator



ES-637-16      Width  
5mm

Matson  
22cm/8¾" length

ES-636-22

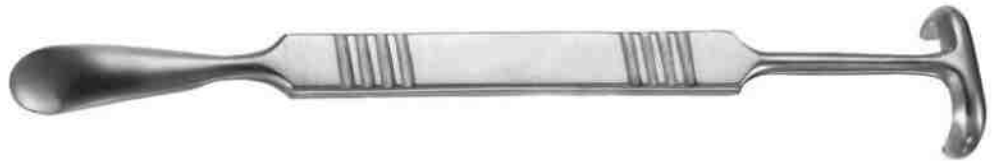

Pennybacker Periosteal Elevator  
16cm/6¼" length  
Curved sharp

ES-654-16      Width  
5mm  
ES-655-16      Width  
7mm



Raspatory  
17cm/6¾" length

ES-637-06      Width  
6mm  
ES-637-08      Width  
8mm



Wagner  
Raspatory  
With Tufnol Handle  
33cm/13" length

Cobb  
Elevator, slightly curved  
25cm/10" length

Hip Raspatory, 21 mm  
With Tufnol Handle  
27.5cm/10 3/4" length

ES-587-27



13mm  
ES-585-13

17mm  
ES-589-17

19mm  
ES-585-19

25mm  
ES-585-25



8mm  
ES-589-08

10mm  
ES-585-10



Raspatory, 6mm  
With Tufnol Handle  
18cm/7" length

ES-604-18



Raspatory, 3mm  
With Tufnol Handle  
18cm/7" length

ES-607-18



Raspatory, 6mm  
With Tufnol Handle  
18cm/7" length

ES-605-18



Raspatory, 6mm  
With Tufnol Handle  
18cm/7" length

ES-603-18



Raspatory, 13mm  
With Tufnol Handle  
18.5cm/7 1/4" length

ES-606-18



Raspatory, 14mm  
With Tufnol Handle  
20cm/8" length

ES-600-20



Raspatory, 14mm  
With Tufnol Handle  
19cm/7 1/2" length

ES-607-19



Raspatory, 13mm  
With Tufnol Handle  
23cm/9" length

ES-608-18





SECTION  
07

OSTEOTOMES & GOUGES



**Bone Chisel**  
13.5cm/5 1/2" length

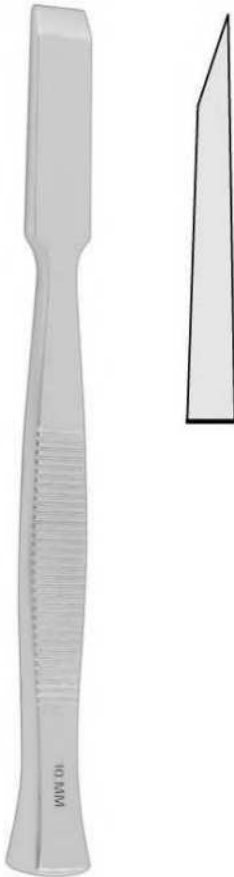

**Bone Osteotome**  
13.5cm/5 1/2" length

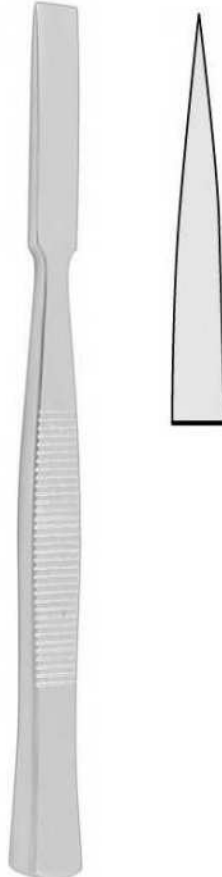

**Bone Gouge**  
13.5cm/5 1/2" length

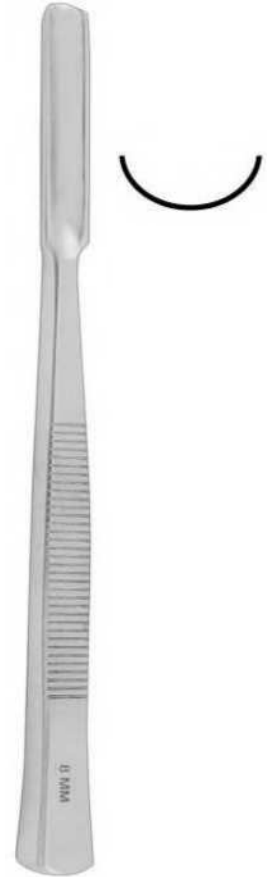

	Width
ES-272-08	8mm
ES-272-10	10mm
ES-272-12	12mm
ES-272-14	14mm
ES-272-16	16mm

	Width
ES-271-08	8mm
ES-271-10	10mm
ES-271-12	12mm
ES-271-14	14mm
ES-271-16	16mm

	Width
ES-270-08	8mm
ES-270-10	10mm
ES-270-12	12mm
ES-270-14	14mm
ES-270-16	16mm



**Hoke**  
16cm/6 1/4" length



Straight		Width	Curved		Width
ES-350-03		3mm	ES-351-03		3mm
ES-350-05		5mm	ES-351-05		5mm
ES-350-06		6mm	ES-351-06		6mm
ES-350-08		8mm	ES-351-08		8mm
ES-350-09		9mm	ES-351-09		9mm

**Mini-Lambotte Osteotome**  
12.5cm/4 3/4" length

	Width	Set of 8 sizes: 2mm to 15mm
ES-340-02	2mm	
ES-340-03	3mm	
ES-340-04	4mm	
ES-340-06	6mm	
ES-340-08	8mm	
ES-340-10	10mm	
ES-340-12	12mm	
ES-340-15	15mm	

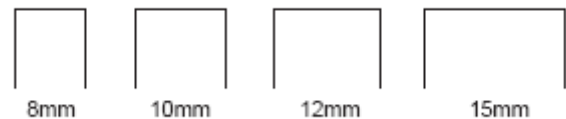
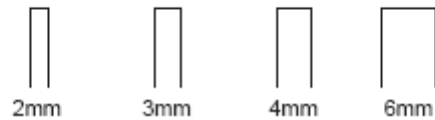

**Mini-Lambotte Osteotome**  
17cm/6 3/4" length

	Width	Set of 8 sizes: 2mm to 15mm
ES-342-02	2mm	
ES-342-03	3mm	
ES-342-04	4mm	
ES-342-06	6mm	
ES-342-08	8mm	
ES-342-10	10mm	
ES-342-12	12mm	
ES-342-15	15mm	

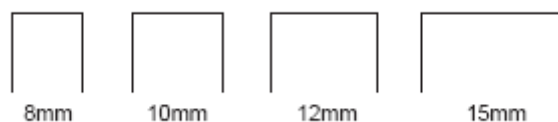
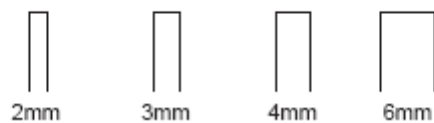

Lambotte Osteotome  
24cm/9 1/2" length

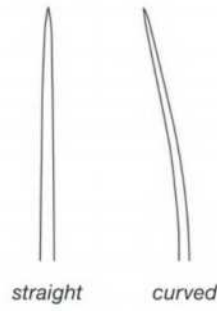

Straight	Width	Curved	Width
ES-346-04	4mm	ES-347-04	4mm
ES-346-06	6mm	ES-347-06	6mm
ES-346-08	8mm	ES-347-08	8mm
ES-346-10	10mm	ES-347-10	10mm
ES-346-13	13mm	ES-347-13	13mm
ES-346-15	15mm	ES-347-15	15mm
ES-346-18	18mm	ES-347-18	18mm
ES-346-20	20mm	ES-347-20	20mm
ES-346-25	25mm	ES-347-25	25mm
ES-346-30	30mm	ES-347-30	30mm
ES-346-38	38mm	ES-347-38	38mm
ES-346-44	44mm	ES-347-44	44mm
ES-346-50	50mm	ES-347-50	50mm

Smith Petersen Osteotome  
20cm/8" length

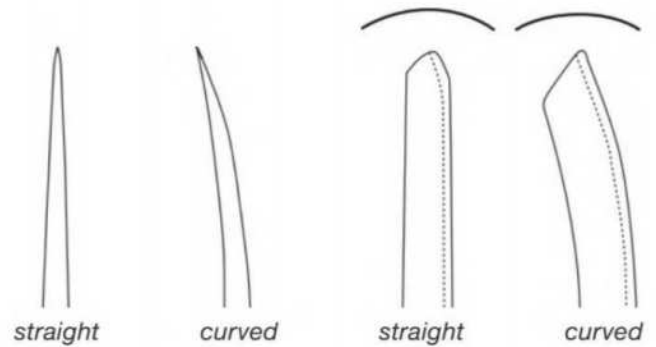

Width	Osteotomes		Gouges	
06mm	ES-321-06	ES-320-06	ES-322-06	ES-323-06
09mm	ES-321-09	ES-320-09	ES-322-09	ES-323-09
13mm	ES-321-13	ES-320-13	ES-322-13	ES-323-13
16mm	ES-321-16	ES-320-16	ES-322-16	ES-323-16
19mm	ES-321-19	ES-320-19	ES-322-19	ES-323-19
25mm	ES-321-25	ES-320-25	ES-322-25	ES-323-25
32mm	ES-321-32	ES-320-32	ES-322-32	ES-323-32

Partsch  
13.5cm/5 1/2" length



Width	Chisels	Gouges
2mm	ES-275-02	ES-279-02
3mm	ES-275-03	ES-279-03
4mm	ES-275-04	ES-279-04
5mm	ES-275-05	ES-279-05
6mm	ES-275-06	ES-279-06

Partsch  
17cm/6 3/4" length



Width	Chisels	Gouges
2mm	ES-276-02	ES-280-02
3mm	ES-276-03	ES-280-03
4mm	ES-276-04	ES-280-04
5mm	ES-276-05	ES-280-05
6mm	ES-276-06	ES-280-06

Alexander  
18cm/8" length



Width	Chisels	Gouges
04mm	ES-284-04	ES-285-04
06mm	ES-284-06	ES-285-06
08mm	ES-284-08	ES-285-08
10mm	ES-284-10	ES-285-10
12mm	ES-284-12	ES-285-12
12mm	ES-284-14	ES-285-14

Stille  
20cm/8" length

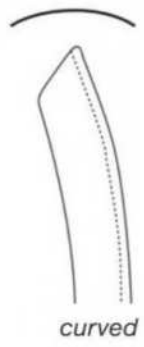
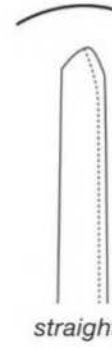
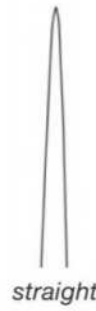
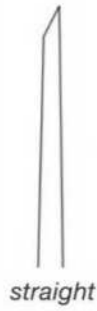

Width	Chisels	Osteotomes			Gouges	
10mm	ES-293-10	ES-294-10	ES-295-10	ES-296-10	ES-297-10	
15mm	ES-293-15	ES-294-15	ES-295-15	ES-296-15	ES-297-15	
20mm	ES-293-20	ES-294-20	ES-295-20	ES-296-20	ES-297-20	
25mm	ES-293-25	ES-294-25	ES-295-25	ES-296-25	ES-297-25	
30mm	ES-293-30	ES-294-30	ES-295-30	ES-296-30	ES-297-30	

Hibbs Osteotome with thin blade  
24cm/9 1/2" length

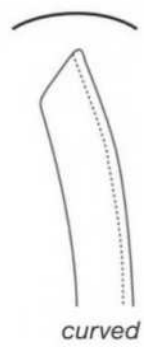
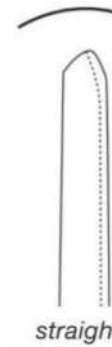
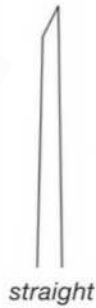

Width	Chisels	Osteotomes			Gouges	
06mm	ES-333-06	ES-334-06	ES-335-06	ES-336-06	ES-337-06	
13mm	ES-333-13	ES-334-13	ES-335-13	ES-336-13	ES-337-13	
19mm	ES-333-19	ES-334-19	ES-335-19	ES-336-19	ES-337-19	
25mm	ES-333-25	ES-334-25	ES-335-25	ES-336-25	ES-337-25	
32mm	ES-333-32	ES-334-32	ES-335-32	ES-336-32	ES-337-32	

Cottle Osteotome  
18.5cm/7 1/4" length



	Width
ES-348-02	2mm
ES-348-04	4mm
ES-348-06	6mm
ES-348-09	9mm
ES-348-12	12mm

Lexer  
25cm/93/4" length  
Tufnol handle



Straight	Width	Angled	Width
ES-300-05	5mm	ES-302-05	5mm
ES-300-10	10mm	ES-302-10	10mm
ES-300-15	15mm	ES-302-15	15mm

Lexer Osteotome  
22cm/83/4" length  
Tufnol handle



Width	Osteotomes	Gouges
07mm	ES-304-07	ES-305-07
10mm	ES-304-10	ES-305-10
15mm	ES-304-15	ES-305-15
20mm	ES-304-20	ES-305-20
25mm	ES-304-25	ES-305-25
30mm	ES-304-30	ES-305-30

Dahmen Osteotome  
30cm/12" length  
Tufnol handle

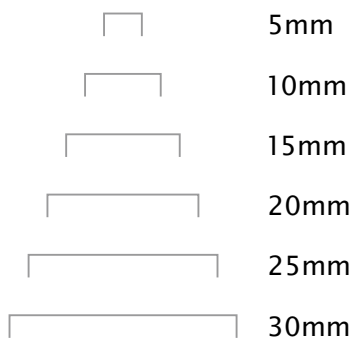

	Straight	Width	Angled	Width
	ES-318-05	5mm	ES-317-05	5mm
	ES-318-10	10mm	ES-317-10	10mm
	ES-318-15	15mm	ES-317-15	15mm
	ES-318-20	20mm	ES-317-20	20mm
	ES-318-25	25mm	ES-317-25	25mm
	ES-318-30	30mm	ES-317-30	30mm

Lexer  
27.5cm/103/4" length  
Tufnol handle



Osteotome	Width
ES-306-10	10mm
ES-306-15	15mm

Gouge	Width
ES-307-10	10mm
ES-307-15	15mm

Cobb  
28cm/11" length  
Tufnol handle

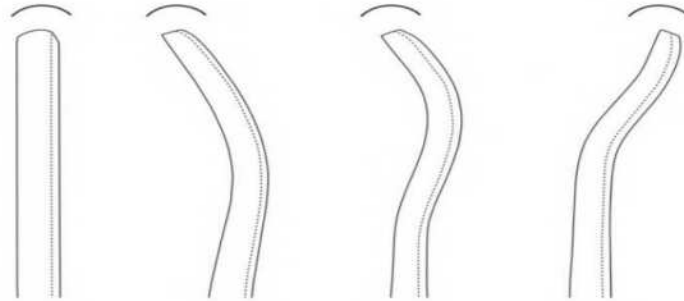

ES-310-01

ES-310-02

ES-310-03

ES-310-04

Cobb  
24cm/9 1/2" length  
Hexagon handle  
gouge, 4mm

ES-342-24



Cobb  
28cm/11" length  
Osteotome

ES-342-28



Box Chisel  
29cm/11 7/2" length  
For preparation of the proximal femur  
31mm width x 6mm

ES-343-29





Mini-Lexer Osteotome  
18cm/7" length  
Tufnol handle

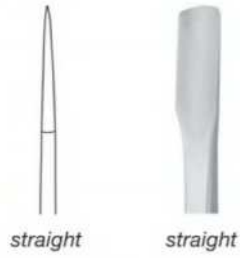

Width	Osteotomes	Gouges
04mm	ES-302-04	ES-303-04
06mm	ES-302-06	ES-303-06
08mm	ES-302-08	ES-303-08
10mm	ES-302-10	ES-303-10
12mm	ES-302-12	ES-303-12

Chisel with Interchangeable Blades  
20cm/8" length  
Tufnol handle  
Very thin blades

ES-345-20  
Complete set with 4 blades & key



5mm

Chisels ES-344-05



10mm

ES-344-10



16mm

ES-344-16



25mm

ES-344-25



5mm

Gouges ES-345-05



10mm

ES-345-10



16mm

ES-345-16



25mm

ES-345-25

Wrench  
9cm/3 7/8" length  
ES-345-00

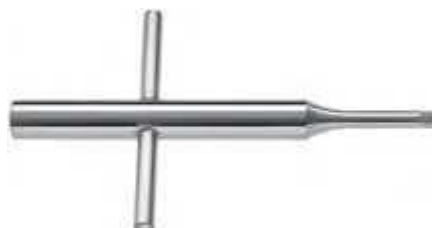

Chisel, Straight  
24.5cm/9 1/2" length  
20mm  
Tufnol handle

ES-312-24



Chisel, Curved  
26.5cm/10 1/2" length  
16mm  
Tufnol handle

ES-315-26



Osteotome  
20cm/8" length  
Tufnol handle

ES-317-20



Zielke  
23cm/9" length  
Tufnol handle



Gouge	Width
ES-315-05	5mm
ES-315-09	9mm

Splitting Gouge, 9mm  
22cm/83/4" length  
Tufnol handle

ES-343-22



Pelvic Osteotome  
30cm/12" length  
Tufnol handle  
Angled shaft

15mm width  
ES-344-15

20mm width  
ES-344-20



Lexer  
28.5cm/113/4" length  
Tufnol handle

Gouge	Width
ES-316-07	7 mm
ES-316-10	10mm



Capener Lamina Gouge  
23cm/9" length  
Cranked shaft

	Width
ES-349-06	6mm
ES-349-08	8mm
ES-349-11	11mm
ES-349-16	16mm





SECTION  
08

MALLETS & TAMPS

Toffee Mallet  
19cm/7½" length  
Head size 22mm Ø  
Weight 165g/6oz

Sc5808-21



Ultra Fine Mallet  
17cm/6¾" length  
Head size 20mm Ø  
Weight 145g/5oz

ES5823-17



Heath Mallet  
19cm/7" length  
Stainless steel head  
Head size 40mm Ø  
Weight 1020g/36oz

ES5809-19



Mallet with Tufnol Handle  
23cm/9" length

Small head size 30mm Ø  
Weight 350g/12oz

ES5803-23

Medium head size 35mm Ø  
Weight 550g/20oz

ES5804-23

Large head size 40mm Ø  
Weight 700g/25oz

ES5805-23



London Splint Mallet  
18cm/7" length  
Head size 30mm Ø  
Weight 450g/16.2oz

ES-409-18



Ombredanne Mallet  
24cm/9 1/2" length  
Head size 40mm Ø  
Weight 550g/20oz

ES-404-24



Mallet with Tufnol Handle  
26cm/10 1/4" length  
Lead filled head  
Weight 400g/14oz

ES-458-26



26cm/10 1/4" length  
Head size 42mm Ø

Plastic, Lead Filled  
Weight 250g/8oz  
ES-456-01

Ferrozell, Without Lead  
Weight 400g/14oz  
ES-456-02



Doyen Mallet  
21 Cm/8 1/4" Length

Small Head Size 25mm Ø  
Weight 120g/4 1/2oz  
ES-408-01



Medium Head Size 30mm Ø  
Weight 180g/6 1/2oz  
ES-408-02

Large Head Size 35mm Ø  
Weight 260g/9oz  
ES-408-03



Small



Medium



Large

Collin Mallet  
20cm/8" Length  
Head Size 30mm Ø  
Weight 220g/7 3/4oz

ES-410-20



Lucae Mallet  
19cm/7 1/2" Length

Head Size 19mm Ø  
Weight 230g/8oz  
ES-409-01



Head Size 25mm Ø  
Weight 260g/9oz  
ES-409-02



19mm



25mm

Cottle Mallet  
19cm/7 1/2" Length  
Head Size 30mm Ø  
Weight 240g/8 1/2oz

ES-430-19

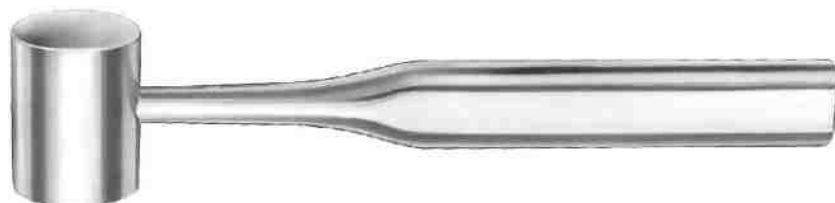

Bergmann Mallet  
23cm/9" length  
Head size 30mm Ø  
Weight 300g/1034OZ

ES-402-23



Bergmann Mallet  
24cm/9 1/2" length  
Head size 45mm Ø  
Weight 300g/1034OZ

ES-400-24



Williger Mallet  
16.5cm/6 1/2" length  
Stainless steel head  
Head size 20mm Ø  
Weight 140g/5oz

ES-416-16



Williger Mallet (Lead Filled)  
24cm/9 1/2" length

Small head size 26mm Ø  
Weight 300g/10 1/2OZ  
ES-406-01

Medium head size 28mm Ø  
Weight 340g/12oz  
ES-406-02

Large head size 30mm Ø  
Weight 400g/14oz  
ES-406-03



Small



Medium



Large



Hajek Mallet  
22cm/872" length  
Head size 27mm  
Weight 140g/5oz

ES-440-22



Mead Mallet  
17cm/634" length

with interchangeable  
(ferrozell faces)  
Head size 26mm Ø (solid)  
Weight 320g/1174oz  
ES-450-17

Head size 26mm Ø  
(ferrozell faces)  
Weight 320g/114OZ  
ES-451 17



Mallet  
26.5cm/672" length

Head size 30mm Ø  
Weight 450g/16oz  
ES-421-26

Head size 50mm Ø  
Weight 900g/32oz  
ES-422-26



Cloward Mallet

23cm/9" length  
Head size 19mm Ø  
Weight 215g  
ES-423-01

19cm/71/2" length  
Head size 25mm Ø  
Weight 220g  
ES-423-02



Thiess Mallet  
16.5cm/6 1/2" length  
Head size 20mm Ø  
Weight 140g/5oz



Lead Filled  
ES-444-16

Brass/ Solid Filled  
ES-445-16

Bergmann Mallet  
26cm/10 1/4" length  
Head size 30mm Ø  
Weight 510g/18oz



ES-448-26

24cm/9 1/2" length  
Stainless steel head  
Head size 30mm/42mm Ø  
Weight 530g/19oz



ES-446-24

18cm/7" length  
With two interchangeable  
Head size 26mm Ø  
Weight 140g/5oz



ES-442-18

ES-442-00

Partsch  
18cm/7" length  
Head size 22mm Ø  
Weight 200g/7oz

ES-454-18



Wagner  
23.5cm/9 1/2" length  
Head size 35mm Ø  
Weight 140g/5oz

ES-461-23



Spare Faces, Pair  
ES-461-00



Repercussion Free  
26cm/10 1/4" length  
Head size 30mm Ø  
Weight 675g/233/40Z

ES-460-26



With Ferrozell Handle  
26cm/10 1/4" length  
Head size 42mm/30mm Ø  
Weight 530g/19oz

ES-462-26



26cm/10 1/4" length  
Steel, Solid

Head size 30mm Ø  
Weight 450g/16oz  
ES-470-01

Head size 50mm Ø  
Weight 900g/32oz  
ES-470-02



With ferrozell faces  
22.5cm/9" length  
Head size 37mm Ø  
Steel, Solid  
Weight 370g/13oz

ES-466-22



Spare Faces, Pair  
ES-467-00



Gerzog  
19cm/7 1/2" length  
Head size 30mm Ø  
Weight 300g/103/4OZ

ES-476-19



For Hand Surgery  
20cm/8" length  
Head size  
18x18mm /7mm Ø  
Weight 80g/23/4OZ

ES-465-20



Steinbach  
24cm/9 1/2" length  
Head size 80x60mm Ø  
Weight 400g/14 1/4OZ

ES-432-24



Gardner Mallet  
14cm/5 1/2" length  
Weight 280g/9340Z

ES-474-14



**Bruenings  
Bone Temper  
16cm/6 1/4" length**



	∅
ES-481-03	3mm
ES-481-05	5mm
ES-481-07	7mm
ES-481-09	9mm

**Passow  
Bone Temper  
12cm/4 3/4" length**



	
2.5mm ∅ ES-482-25	3.5mm ∅ ES-482-35

**Bone Temper  
15cm/6" length  
Round Handle**



	∅		∅
ES-649-01	1mm	ES-649-05	5mm
ES-649-02	2mm	ES-649-06	6mm
ES-649-03	3mm	ES-649-08	8mm
ES-649-04	4mm	ES-649-10	10mm

**Bone Temper  
15.5cm/6" length  
Round Handle**



	∅		∅
ES-648-02	2mm	ES-648-06	6mm
ES-648-03	3mm	ES-648-08	8mm
ES-648-04	4mm	ES-648-10	10mm
ES-648-05	5mm		

**Bone Temper  
15.5cm/6" length**



ES-485-15



10mm

Bone Temper  
With ferrozell handle



Straight, Serrated

- ES-483-01 25.5cm/10"
- ES-483-02 28cm/11"
- ES-483-03 31.5cm/12"



Straight, Smooth

- ES-483-04 25.5cm/10"
- ES-483-05 28cm/11"
- ES-483-06 31.5cm/12"



Curved, Smooth



Straight, Serrated

Curved, Smooth

- ES-483-07 25.5cm/10"
- ES-483-08 28cm/11"
- ES-483-09 31.5cm/12"

Bone Temper  
28cm/11" length  
Round 17x7mm,  
Straight  
With ferrozell handle



ES-484-28



Bone Temper  
With ferrozell handle  
35cm/133/4" length



19x14mm  
ES-485-14

15x10mm  
ES-485-10

Cement Temper  
Double Ended 7mm/3mm  
23cm/9" length



ES-486-23

Caspar  
Bone Temper  
with synthetic handle  
20cm/8" length

	Width
ES-487-12	12mm
ES-487-14	14mm
ES-487-16	16mm



Caspar  
Bone Temper  
with synthetic handle  
20cm/8" length

	Width
ES-487-03	3mm
ES-487-05	5mm
ES-487-08	8mm



Sypert  
Bone Temper  
With ferrozell handle  
29cm/11 1/2" length



  
3x8mm  
ES-489-08

  
4x10mm  
ES-489-10

  
5x15mm  
ES-489-15

  
6x20mm  
ES-489-20





SECTION  
09

FILES & RASPS

**Fomon**  
21cm/874" length  
TC Rasp, 7x40mm  
Double Ended



- ES-637-12 Fig. 1/Fig.2
- ES-637-34 Fig. 3/Fig.4
- ES-637-56 Fig.5/Fig.6
- ES-637-78 Fig.7/Fig. 8
- ES-637-90 Fig.9/Fig. 10

**Parkes**  
21 cm/814" length  
TC Rasp, 8x39mm  
Straight



- |           |        |           |         |
|-----------|--------|-----------|---------|
| ES-638-01 | Fig. 1 | ES-638-06 | Fig.6   |
| ES-638-02 | Fig.2  | ES-638-07 | Fig. 7  |
| ES-638-03 | Fig.3  | ES-638-08 | Fig. 8  |
| ES-638-04 | Fig.4  | ES-638-09 | Fig. 9  |
| ES-638-05 | Fig.5  | ES-638-10 | Fig. 10 |

**Maltz**  
16.5cm/61/2" length  
TC Rasp



- ES-639-02 Fig.2
- ES-639-03 Fig.3
- ES-639-04 Fig.4
- ES-639-05 Fig.5
- ES-639-06 Fig.6

**Aufricht**  
20cm/73/4" length  
Rasp 7x25mm  
Fine, Curved  
Diamond Jaws



ES-641-20

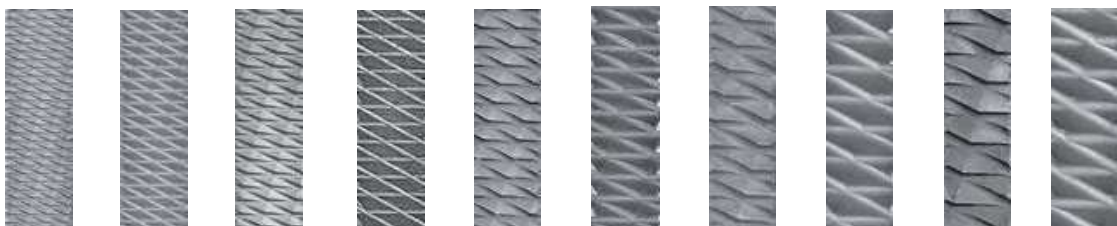
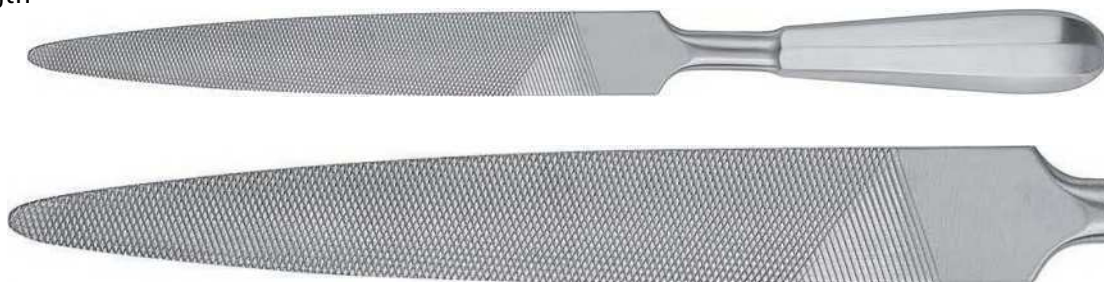

Fig. 1 0.8    Fig.2 1.1    Fig.3 1.3    Fig.4 1.6    Fig.5 1.8    Fig.6 2.0    Fig. 7 2.4    Fig. 8 2.6    Fig.9 2.8    Fig. 10 3.0

Bone File with hollow handle  
Semi Round  
28cm/11" length

ES-640-28



Bone File, Bayonet Shaped  
24.5cm/9 1/2" length

ES-642-24



Bone File/ Rasp  
22cm/8 3/4" length

ES-644-22



Fomon  
21cm/81/4" length  
TC Rasp, 7x40mm  
Double Ended

ES-643-21

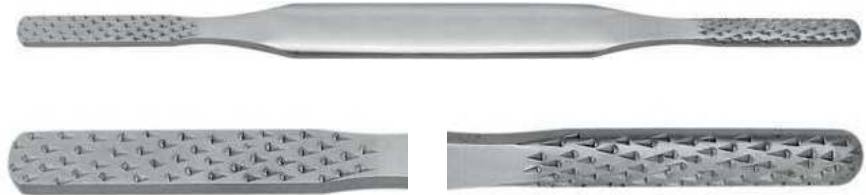

Fomon  
20cm/73/4" length  
Rasp 7x25mm  
Fine, Curved  
Diamond Jaws

ES-645-20



Fomon  
21cm/81/4" length  
TC Rasp, 7x40mm  
Double Ended

ES-646-21



Kleinert-Kutz  
22cm/83/4" length  
Rasp, 4Sides  
Double Ended

ES-647-22

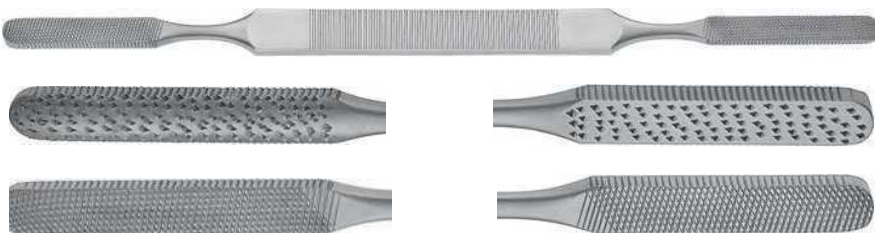

Miller  
21cm/81/4" length  
90° Cross Serrated  
Cut on down stroke



- ES-649-01 Fig. 1 8mm/5mm
- ES-649-02 Fig. 2 6mm/4mm
- ES-649-03 Fig. 3 6mm/5mm



Putti  
30cm/113/4" length  
Bone File  
ES-650-30



Putti  
27cm/103/4" length  
Bone File  
ES-651-27



Gallaher  
17cm/634" length  
Rasp with ring  
Coarse  
ES-653-17



Aufricht  
22cm/83/4" length  
Rasp, 90° Cross Serrated

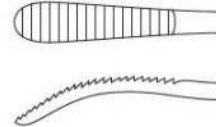
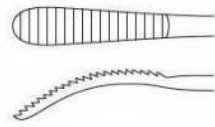

ES-654-22

ES-655-22

Joseph  
16.5cm/61/2" length  
Rasp, Cross Serrated



ES-656-16    Fine  
ES-657-16    Coarse

Lewis  
17.5cm/7" length  
Rasp, Set to cut  
On down stroke

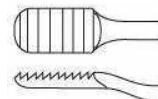
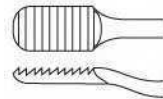

Fine 1  
ES-658-17

Coarse  
ES-659-17

Maltz  
8cm/7" length  
Rasp, Straight



Backward Cutting	Forward Cutting
ES-651-18 1	ES-652-18
ES-661-18/TC	ES-662-18/TC

Maltz (Cottle)  
21 cm/81/4" length  
Rasp, Backward cutting



ES-664-21





SECTION

10

BONE RONGEURS

**Kleinert-Kutz Bone Nibbler**  
14cm/5 1/2" length  
Curved

2mm Bite  
ES-842-02



**Lempert Bone Nibbler**  
19cm/7 1/2" length  
Single action

3mm Bite  
ES-864-19



3mm Bite  
ES-865-19



**Lempert Bone Nibbler**  
16cm/6 1/4" length  
Single action

3mm Bite  
ES-864-16



3mm Bite  
ES-865-16



**Adsons Bone Nibbler**  
20cm/8" length  
Single action

7mm Bite  
ES-878-20



7mm Bite  
ES-879-20





Stellbrink  
17cm/63/4" length  
Light Curved

ES-841-01



Stellbrink  
Synovectomy Rongeur  
16.5cm/61/2" length  
Strong Curved

ES-841-02



Mini-Friedmann  
12cm/43/4" length  
Delicate jaw, 1.1mm

ES-843-12



Defourmental  
19cm/71/2" length

ES-874-19



Friedmann  
14cm/5 1/2" length

ES-845-14



Friedmann-Mini  
15cm/6" length  
90° Curved

ES-846-01

14cm/5 1/2" length  
90° Curved

ES-846-02



Hakansson  
17cm/6 3/4" length

ES-850-17



Cleveland  
14cm/5 1/2" length

ES-851-14

17cm/6 3/4" length  
ES-853-17



Mead  
16.5cm/6 1/2" length  
Round Jaw

ES-855-16  
16.5cm/6 1/2" length

Square Jaw  
ES-856-16



Beyer  
18cm/7" length  
ES-857-18

17cm/6 3/4" length  
2mm  
ES-858-02

17cm/6 3/4" length  
3mm  
ES-858-03



Hartmann  
18.5cm/7 1/4" length

ES-859-18



Luer  
15cm/6" length



ES-875-15

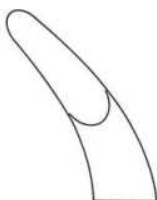

ES-876-15

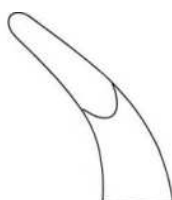

ES-877-15



Luer  
18cm/7" length  
13x8mm wide jaw



ES-872-18



ES-873-18



Jansen  
Curved double action  
18cm/7" length /4mm Bite



Straight  
ES-860-18



Light Curve  
ES-861-18



Strong Curve  
ES-863-18



Blumenthal



Curved  
15cm/6" length  
ES-866-15



45°  
14.5cm/53/4" length  
ES-867-14



90°  
14cm/51/2" length  
ES-869-14



Universal  
13.5cm/5 1/4" length

ES-870-13



Olivecrona  
20cm/8" length  
5mm wide jaw

ES-871-20

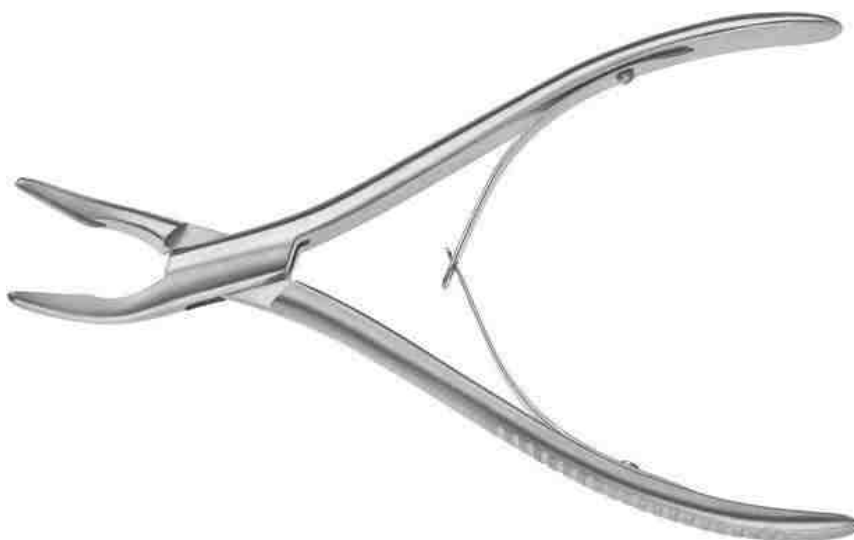

Bane  
18cm/7" length

ES-892-01

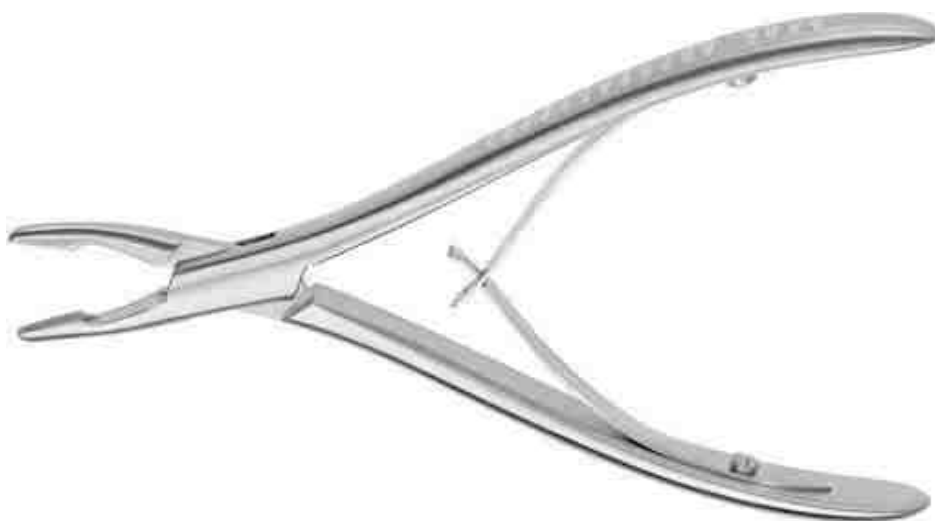

Guleke  
20.5cm/8" length

ES-892-05



Jansen  
19cm/7 1/2" length  
4mm wide jaw

ES-892-04



Wilms  
20cm/8" length  
4mm wide jaw

ES-892-07



Trotter  
20cm/8" length  
7mm wide jaw

ES-892-08



**Bohler Bone Nibbler**  
Curved double action  
15cm/6"

Straight	Curved	Bite Size
ES-880-15	ES-881-15	3mm
ES-880-02	ES-881-02	2mm



straight curved



**Marquardt Bone Nibbler**  
20cm/8" length  
Curved double action

3mm Bite  
ES1002-20



**Beyer Bone Nibbler**  
Curved double action  
18cm/7"

4mm Bite  
ES1002-18



**Jansen Bone Nibbler**  
Curved double action  
18cm/7"

5mm Bite  
Es1003-18

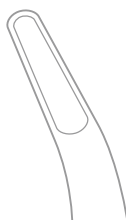

Mayfield  
Curved, 4mm  
17cm/63/4"

ES-887-17



Ruskin  
19cm/71/2" length

Straight  
ES-890-18

Curved  
ES-891-18

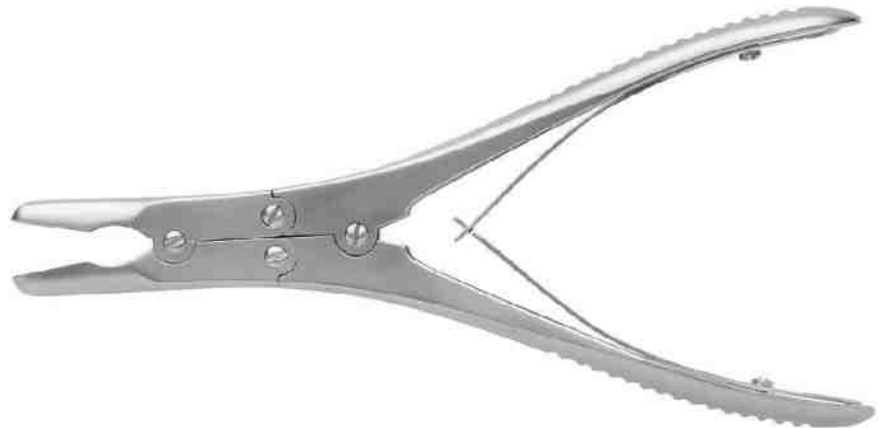

Ruskin  
23cm/9" length

Straight, 5mm  
ES-890-23

Curved, 5mm  
ES-891-23



Kleinert-Kutz  
15cm/6" length



ES-897-01



ES-897-02





Smith-Peterson Bone Nibbler  
24cm/9 1/2" length  
Double action

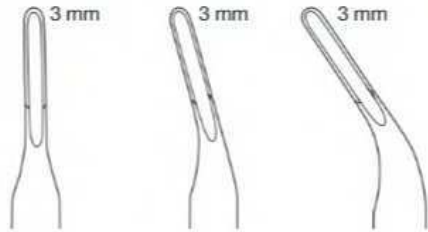

straight      slightly curved      curved

ES-902-01      ES-902-02      ES-902-03



Ruskin-Mini  
15cm/6" length

Straight, 2mm  
ES-898-02

Curved, 2mm  
ES-899-02

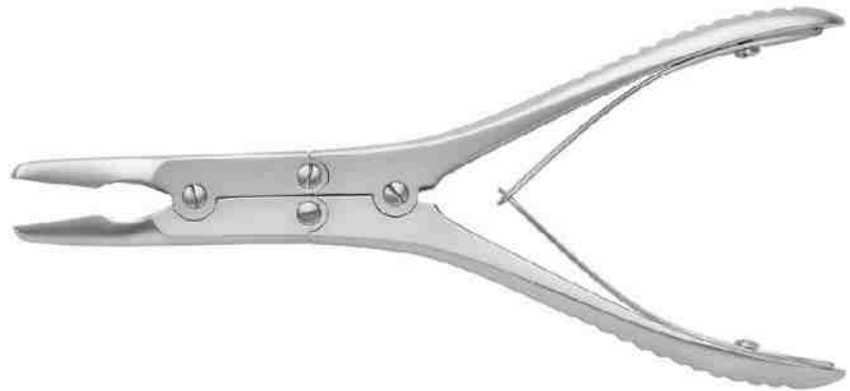

Ruskin-Mini  
15cm/6" length

Straight, 3mm  
ES-898-15

Curved, 3mm  
ES-899-15



Rz Cera-Cut Rongeur  
More durable  
Longer Resistance

ES-900-15



Leksell Bone Nibbler  
24cm/9½" length  
Double action angled



Angled Jaw	Bite Size
ES101 8-24	3mm
ES101 9-24	5mm
ES1020-24	8mm

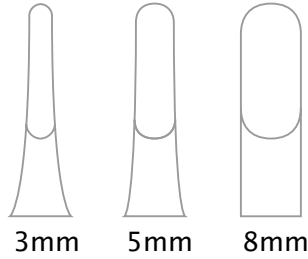

Stille-Luer Bone Nibbler  
22cm/8¾" length  
Double action

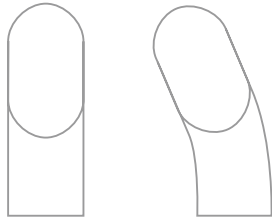

Straight 10mm Bite ES1006-22	Curved 10mm Bite ES1007-22
------------------------------------	----------------------------------



'Mr Blobby' Stille-Luer Bone Nibbler  
26cm/10¼" length  
Double action

Straight 17mm Bite ES1008-26	Curved 17mm Bite ES1009-26
------------------------------------	----------------------------------

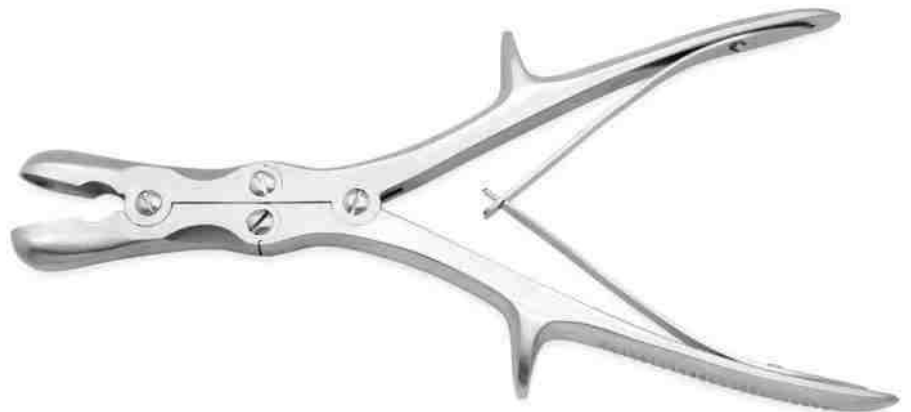

Sauerbruch  
30cm/12"length



Straight, Angular  
ES-930-30

Straight, Round  
ES-932-30

Sypert  
35cm/14" length



Code	Bite Size
ES-936-08	8mm
ES-936-05	5mm
ES-936-03	3mm

Dale  
35cm/14" length



Code	Bite Size
ES-937-08	8mm
ES-937-03	3mm

Scaphoid Spreader - Fine Pattern

14cm/5½" length

1 x 2 prongs

6mm  
ES131-14



Scaphoid Spreader - Standard Pattern

14cm/5½" length

6mm  
ES134 -14



Baby Inge Bone Spreader

18cm/7" length

7mm  
Toothed



ES134 -18

7mm  
Smooth



ES134-18S

7mm  
Cross Serrated



ES134-18X

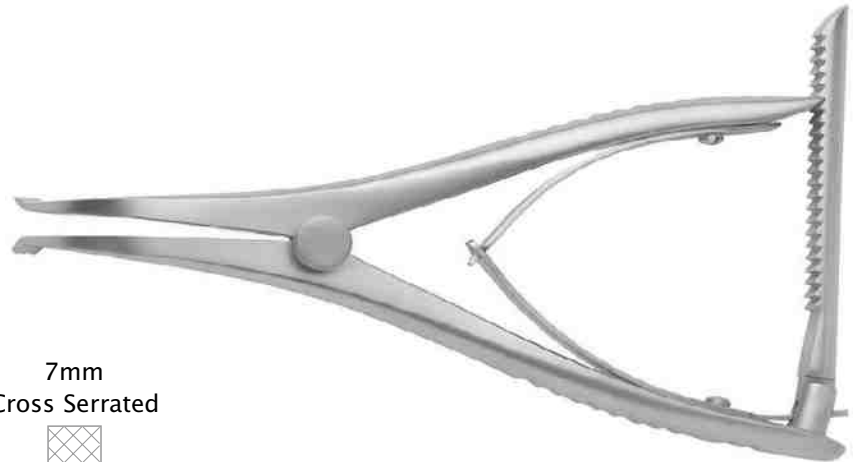

Scaglietti Lamina Spreader

28cm/11" length

With speed lock

ES2009-28

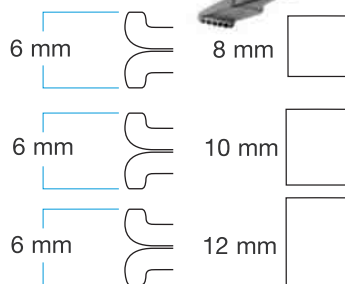

130



BONE CUTTERS

Bohler Bone Cutters  
15cm/6" length  
Double action

Straight  
ES-960-15

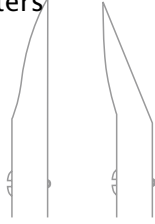

Angled  
ES-961-15



McIndoe Bone Cutters  
18cm/7" length  
Double action  
Angled jaws

ES-957-17



Ruskin-Liston Bone Cutters  
19cm/7 1/2" length  
Double action

Straight  
ES-978-23



Angled  
ES-979-23



Stille-Liston Bone Cutters  
27cm/10 3/4" length  
Double action

Straight  
ES-978-27

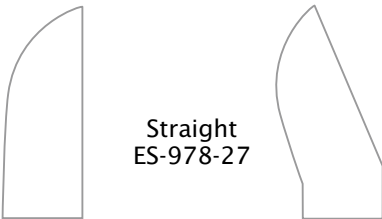

Angled  
ES-979-27

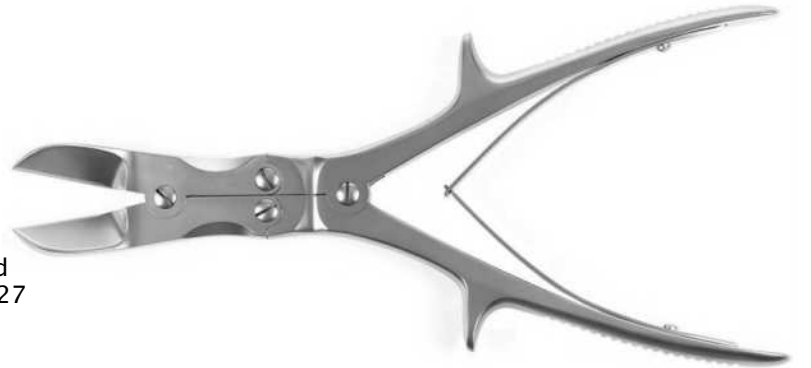

Liston Key Horsley Bone Cutters  
27cm/10 3/4" length  
Double action  
Angled

ES-976-27



Ruskin-Liston Bone Cutters  
18cm/7" length  
Double action



Straight  
ES-954-18



Angled  
ES-955-18

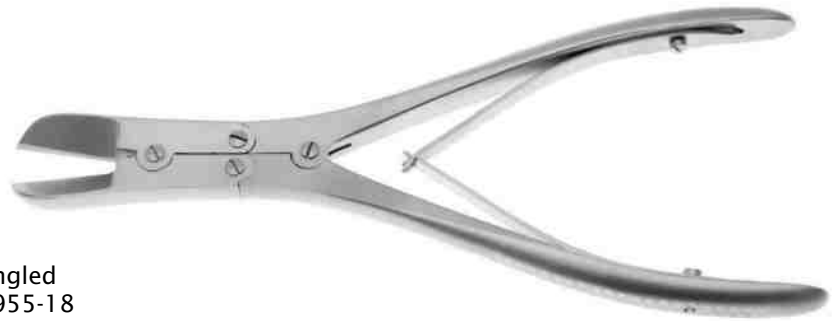

Kleinert-Kutz  
15cm/6" length

Straight  
ES-952-15

Angled  
ES-953-15



Markwalder  
20cm/8" length

ES-943-20



Liston



Straight	Curved	Length
ES-946-14	ES-947-14	14cm/5 1/2"
ES-846-17	ES-947-17	17cm/6 3/4"
ES-946-19	ES-947-19	19cm/7 1/2"
ES-946-22	ES-947-22	22cm/8 3/4"

Cleveland  
15cm/6" length

ES-951-15



Cleveland  
17cm/6 3/4" length

ES-951-17



Cleveland Gardner  
16cm/6 1/4" length

ES-941-16





Littauer-Liston  
15cm/6" length

Straight  
ES-948-15



Cutter  
12cm/43/4" length

ES-965-12



Cottle Kazanjian  
19cm/7 1/2" length

Straight  
ES-940-19



Walton-Liston  
15cm/6" length



Straight  
ES-962-15



Angled  
ES-963-15



Semb  
24cm/9 1/2" length

ES-973-24

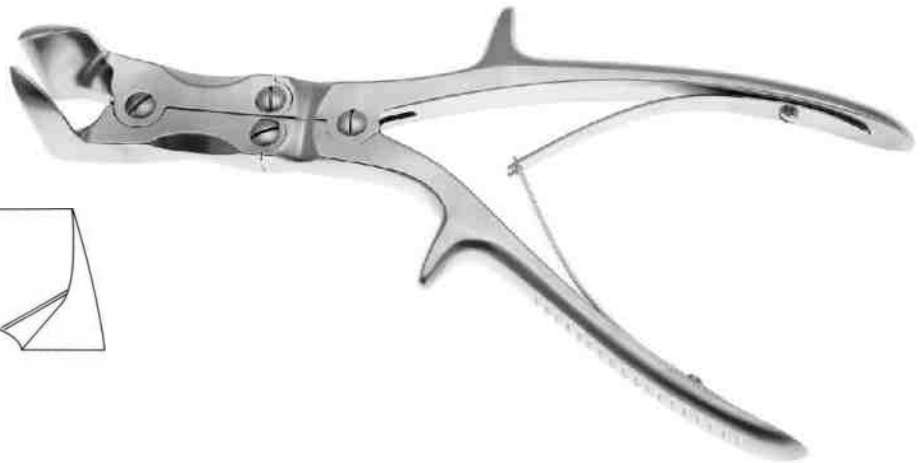
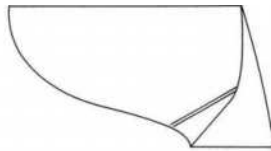

Liston-Key-Horsley Bone Cutters  
27cm/10 3/4" length  
Double action  
Angled



ES-972-27





SECTION

12

PLASTER CAST SPREADERS  
& SCISSORS

Lister  
Bandage Scissors

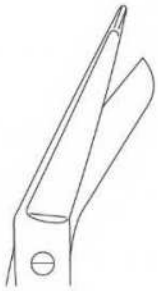

11cm/4 1/2" length  
ES-712-11

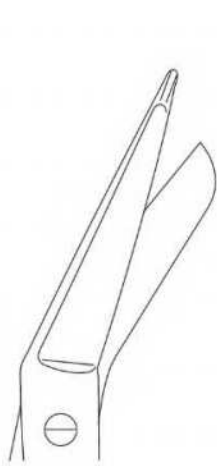

9cm/7 1/2" length  
ES-712-09

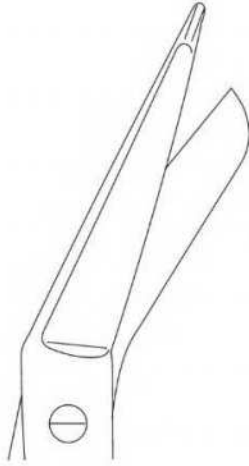

14cm/5 1/2" length  
ES-712-14

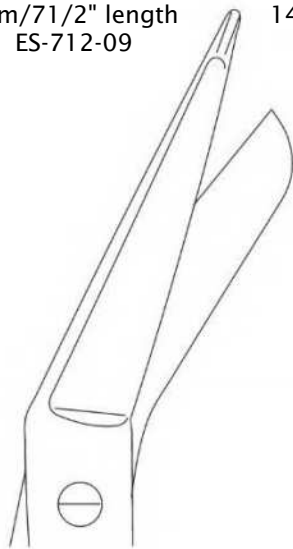

18cm/7" length  
ES-712-18

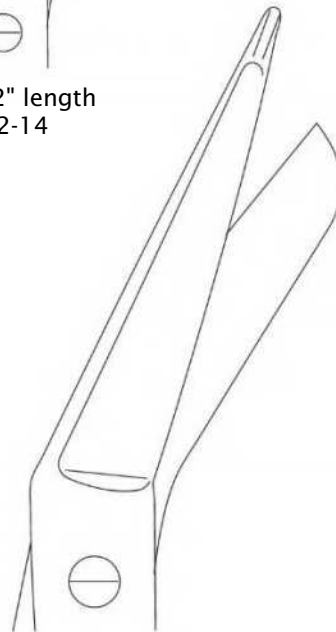

20cm/8" length  
ES-712-20

Lister  
Bandage Scissors  
18cm/7" length

ES-718-18 TC  
ES-719-18 Super-Cut



Lister  
Bandage Scissors  
Large Bow

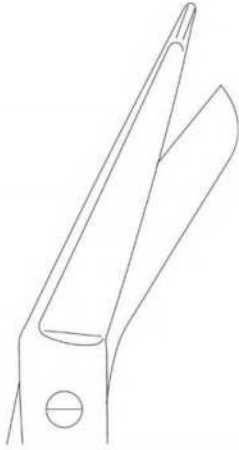

ES-715-18  
ES-715-20

Length  
18.5cm/7 3/4"  
20cm/8"

Lister-Excentric  
Bandage Scissors  
Serrated

ES-716-16  
ES-716-19

Length  
16cm/6 1/4"  
19cm/7 1/4"



Esmarch  
Plaster Scissors

ES-718-20  
ES-718-22

Length  
20cm/8"  
22cm/8 3/4"



Bergmann  
Plaster Scissors  
23cm/9" length

ES-721-23



Sevlin  
Cloth and Plaster Scissors  
Serrated  
23cm/9" length

ES-722-23



Cloth Scissors  
Serrated  
20cm/8" length

ES-721-20



Smith (Med. USA)  
Bandage Scissors

Length  
ES-726-18 18cm/7"  
ES-726-23 23cm/9"



Lorenz  
bandage Scissors, Curved  
23cm/49" length

ES-728-23



Bruns  
Plaster Scissors  
24cm/9 1/2" length

ES-730-24 Serrated  
ES-731-24 Smooth



Knowles  
Bandage Scissors  
14cm/5 1/2" length

ES-732-14 Straight  
ES-7ES-14 Angled



Knowles  
Bandage Scissors, Knee angled shaft  
14cm/5 1/2" length

ES-734-14



Universal  
Plaster and Cloth Scissors  
With Protection Cup  
With Plastic Rings, Auto Clavable



Additional Available  
Ring Colors



15.5cm/6" length

ES-206-15	Blue
ES-207-15	Orange
ES-208-15	Red
ES-209-15	Black
ES-210-15	Green
ES-211-15	yellow

18.75cm/7 1/2" length

ES-206-18	Blue
ES-207-18	Red
ES-208-18	Orange
ES-209-18	Black
ES-210-18	Green
ES-211-18	yellow



Universal  
Plaster and Cloth Scissors  
With Protection Splint  
With Plastic Rings, Auto Cleavable  
14cm/5 1/2" length



Additional Available  
Ring Color



- ES-740-01 Pink
- ES-740-02 Blue Pink



Mini-Stille  
Plaster Cast Scissors  
18cm/7" length

ES-742-18



Stille  
Plaster Cast Scissors  
24cm/9 1/2" length

ES-743-24



Stille  
Plaster Cast Scissors



23cm/9" length  
ES-744-23



26cm/1074" length  
ES-744-26



37cm/1412" length  
ES-744-37

Spare Blade	For
ES-745-01	ES-744-23
ES-745-02	ES-744-26
ES-745-03	ES-744-37

Lorenz  
Plaster Cast Spreader  
Single Hand Model  
23cm/9" length

ES-747-23



Henning  
Plaster Spreader  
28cm/11" length

ES-748-28



Beeson  
Plaster Spreader  
30cm/12" length

ES-749-30



Hermann  
Plaster Spreader  
48cm/19" length

ES-750-48



Wold-Boehler  
Plaster Cast Breaker

Length  
ES-751-18 18cm/7"  
ES-751-24 24cm/9 1/2"



Hopkin  
Plaster Knife  
20cm/8" length

ES-752-20



Esmarch  
Plaster Knife  
18cm/7" length

ES-753-18



Reiner  
Plaster Knife  
18.5cm/7 1/4" length

ES-754-18



Bergmann  
Plaster Cast Saw  
24cm/9 7/8" length

ES-755-24



Engel  
Plaster Saw  
15cm/6" length

ES-756-15





SECTION

13

AMPUTATION SAW  
& KNIVES

**Cottle  
Amputating Knife**



	Blade Length
ES-765-13	13cm/5"
ES-765-16	16cm/6 1/4"
ES-765-19	19cm/7 1/2"
ES-765-22	22cm/8 3/4"
ES-765-28	28cm/11"

**Catlin  
Amputating Knife  
Double Cutting**



	Blade Length
ES-766-16	16cm/6 1/4"
ES-766-19	19cm/7 1/2"
ES-766-22	22cm/8 3/4"

**Phalangeal Knife  
30cm/12" length**



ES-768-30

**Interosseous Knife  
11cm/7" working length**



ES-769-11



**Walb  
Organ Knife  
With wooden handles**



	Blade Length
ES-771-11	11cm/7"
ES-771-14	14cm/9 1/2"
ES-771-17	17cm/9 2/2"

Helferich B  
Amputation Saw  
39cm/15 1/2" length

ES-775-39



Spare Blade

- |           |     |
|-----------|-----|
| ES-775-04 | 4mm |
| ES-775-06 | 6mm |
| ES-775-08 | 8mm |

Charriere  
Amputation Saw



Length

- |           |              |
|-----------|--------------|
| ES-112-27 | 27cm/10 1/2" |
| ES-112-30 | 30cm/12"     |

Satterlee  
Amputation Saw  
31cm/12 1/4" length

ES-122-31



Langenbeck  
Metacarpal Saw  
23cm/9" length.

ES-110-23





Charriere  
Amputation Saw  
35cm/14" length

ES-100-35



Spare Blade

- ES-100-12 12mm
- ES-100-15 15mm
- ES-100-18 18mm

Rust  
Amputation Saw  
39cm/15 1/4" length

ES-784-39



Spare Blade

- ES-784-01 12mm
- ES-784-02 15mm
- ES-784-03 18mm

Percy  
Amputating Retractor  
With Removable Handle

ES-838-30



Percy  
Amputating Retractor  
With Stowable Handle

ES-838-50





SECTION

14

MEASURING INSTRUMENTS  
CALIPERS & SCALES

**Stainless Steel Measuring Ruler**  
Ruler with mm  
and inch marking

Code	Length
EM-RU-04	15cm/6"
EM-RU-08	30cm/12"



**Depth Gauge**



		Measuring depth
ES-700-00	Mini	up to 40mm
ES-704-00	Small	up to 70mm
ES-708-00	Large	up to 110mm

**Measuring Caliper**  
25cm/10" length  
Measuring range 0-50mm

ES-789-25



**Moeltgen  
Goniometer**

ES-260-01



Direct Reading Depth Gauge  
23cm length  
Measuring depth up to 40mm

ES-790-23



Castroviejo  
Caliper  
Measuring range 0-20mm  
With locking screw  
90mm

ES-304-06



Castroviejo  
Caliper  
Measuring range 0-20mm  
With locking screw  
90mm

ES-304-06



Carrol  
Finger Goniometer  
25cm/10" length

ES-214-14



Caspar  
Caliper for measuring bone craft  
Scale in mm, max 180mm  
Inside/Outside measuring, faces & depth

ES-792-18

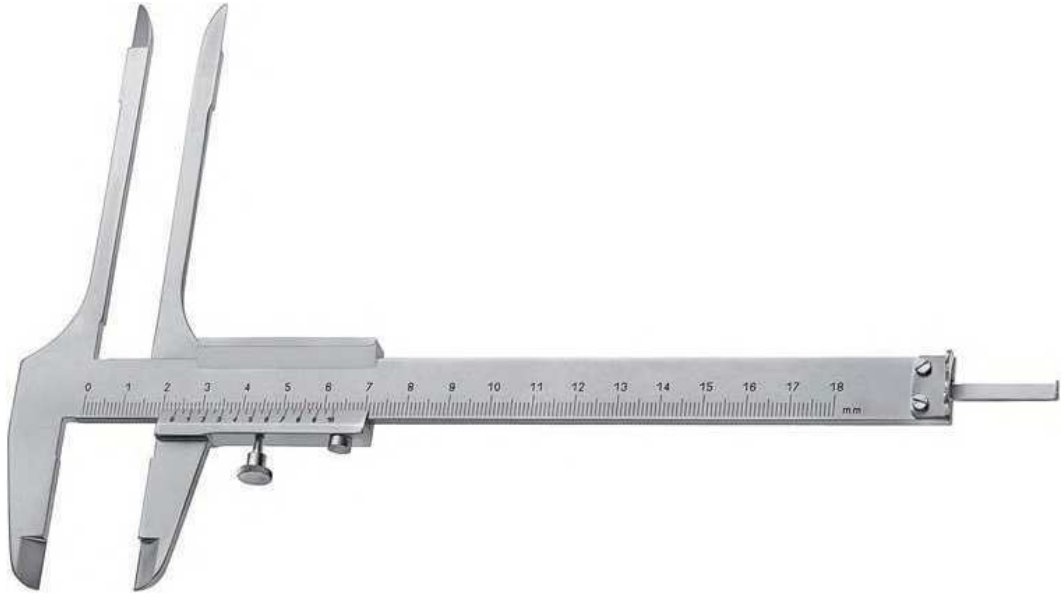

Neuro Caliper  
Scale in mm, max  
180mm

ES-793-18

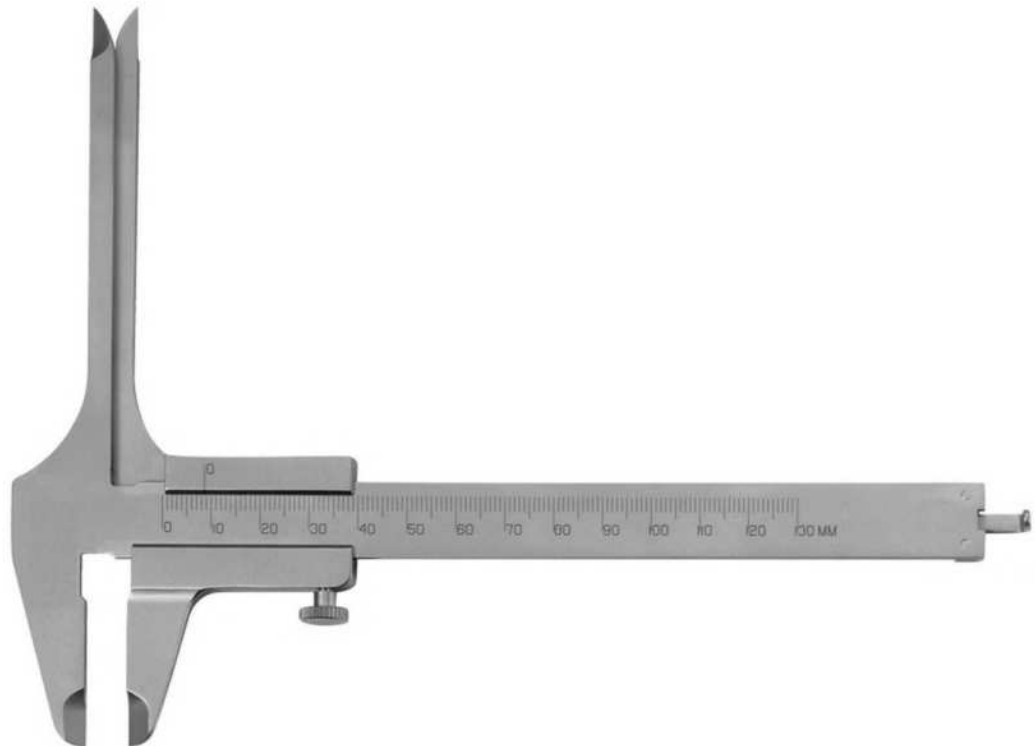

Jameson  
Caliper, 0-100mm  
100mm/4"

ES-795-04



Townley  
Caliper, 0-80mm

ES-795-10



Thorpe  
Caliper, 0-80mm

ES-795-12





PODIATRIC



Nail Nipper  
Barrel Spring, Screw Lock  
Concave edge

Code	Length
ES-802-12	12cm/43/4"
ES-802-14	14cm/51/2"



Nail Nipper  
Double Spring,  
Concave edge  
14cm/51/2" length

ES-803-14



Cutical Nipper  
Double Spring  
Convex edge

Code	Length
ES-804-14	14cm/51/2"
ES-804-15	15cm/6"



Mycotic Nail Nipper  
Heavy duty jaw  
Double Action  
15cm/6" length



ES-806-15      Straight  
ES-807-15      Concave



Straight

Concave

Nail Nipper  
Concave edge

Code	Length
ES-810-10	10cm/4"
ES-810-13	13cm/5"
ES-810-14	14cm/5 1/2"
ES-810-15	15cm/6"



Nail Nipper  
Straight  
13cm/5" length

ES-812-13



Cuticle Nipper With Scissors Grip  
Straight Jaws  
Ring Handle  
10cm/4" length

ES-836-10



Radolf  
Nail Extraction Forceps  
13.5cm/5 1/4" length

ES-988-13



Nail Extraction Forceps  
Duck Jaw  
14.5cm/5 3/4" length

ES-989-14



Radolf  
Nail Extraction Forceps  
14cm/5 1/2" length

ES-818-14



Finger Ring Saw  
With replaceable circular blade  
17cm/63/4" length

ES-984-17

Only Saw  
ES-985-01



Walton  
Finger Ring Saw  
with the replaceable circular blade  
16cm/614" length

ES-982-16

Only Saw  
ES-983-01



Mod. Martin  
Finger Ring Saw  
with the replaceable circular blade  
17cm/634" length

ES-980-17

Only Saw  
ES-981-01



Cuticle Nail Scissors  
Curved

ES-260-01



Piffard  
Lupus Curette

ES-823-00

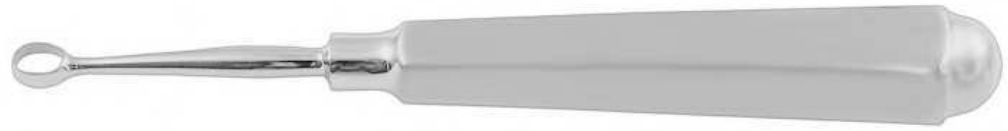

Fig. 1  
ES-823-01



Fig. 2  
ES-823-02



Fig. 3  
ES-823-03

Finger Nail Drill  
with replaceable circular blade  
16cm/6 1/4" length

ES-370-10

Complete Set  
(ES-370-10, ES-371-01, ES-371-02, ES-371-03)

ES-371-00



ES-371-01



ES-371-02



ES-371-03

Keys  
Dermal Punch Set  
12cm/4 3/4" length

ES-822-00

Handle Only  
ES-822-01

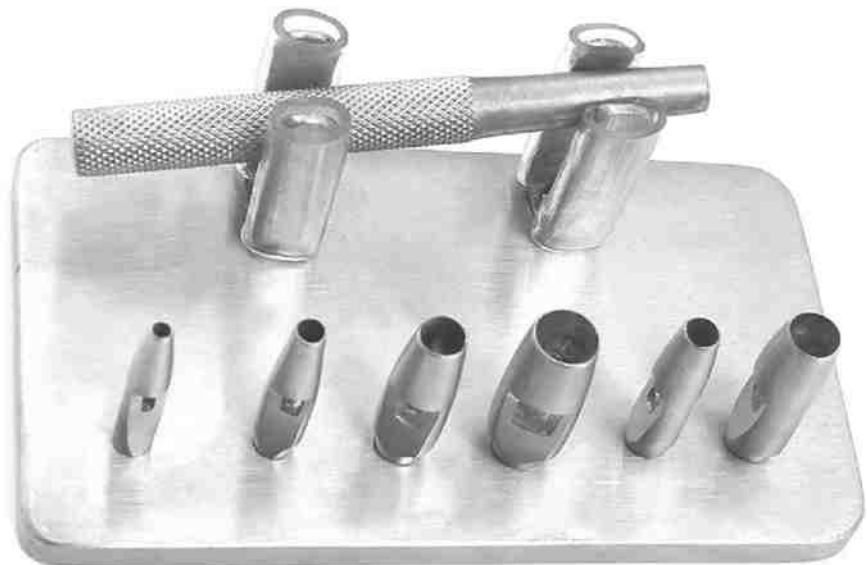

Head	Size
ES-822-02	2mm
ES-822-03	3mm
ES-822-04	4mm
ES-822-05	5mm
ES-822-06	6mm
ES-822-07	7mm

Lead Hand  
Child Size  
ES-360-01

Adult Size  
ES-360-02



Feldheim  
Nail Instrument  
10cm/4" length

ES-366-10





SECTION

16

PLIERS & WIRE  
CUTTERS

Universal Fine Pliers and Cutters  
15cm/6" length

ES-208-15

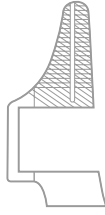

Slim & Square Ended Wire Pliers

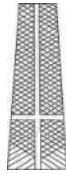
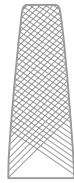

Slim Nose  
ES-208-03  
19cm/7 1/2"

Square Ended  
ES-208-02  
17cm/6 3/4"

ES-208-01  
17cm/6 3/4"



Pliers for Screw Removal  
20cm/8" length

ES-207-20



Muller Claus Wire Pullers  
18cm/7" length  
Double action  
Tungsten jaws

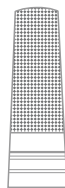
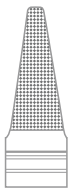

2mm Jaws  
ES-239-02

4mm Jaws  
ES-239-04

6mm Jaws  
ES-239-06





Flat Nose Plier TO  
18cm/7" length



Fig. 1  
ES-210-01



Fig. 2  
ES-210-02

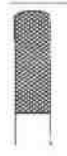

Fig.3  
ES-210-03



Wire Extraction Plier  
18cm/7" length



Fig. 1  
ES-212-18



Fig. 2  
ES-216-18



Fig.3  
ES-216-18



Wire Cutting Forceps  
15cm/6" length

ES-219-01

For Hard Wire  
Cuts wire up to 1.0mm Ø

For Soft Wire  
Cuts wire up to 1.5mm Ø



Waldsach  
Universal Plie  
16cm/61/4" length

ES-219-02



Wire Cutting Plier

Slim Nose

ES-219-03

13cm/5"

Thick Nose

ES-219-04

18cm/7"



Wire Holding Forceps  
14cm/5 1/2" length

With Serrated Jaws  
ES-219-05

With One Jaw Smooth  
ES-219-06



Hackstocks  
With Longitudinal Groove  
16cm/6 1/4" length

ES-219-16

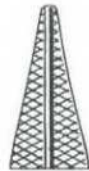

Angle Wire Cutter  
13cm/5" length

ES-219-01

For Hard Wire  
Cuts wire up to 0.3mm Ø

For Soft Wire  
Cuts wire up to 0.5mm Ø

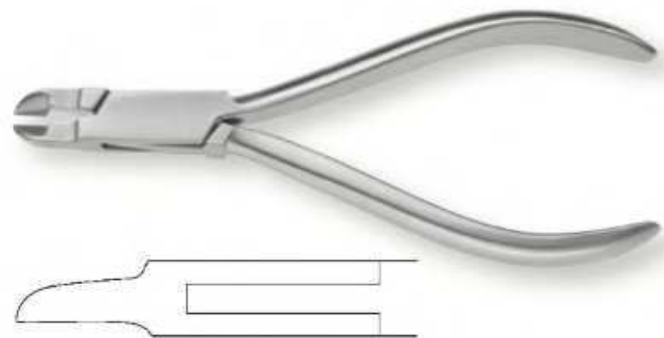

Martin  
TC Wire Twisting Forceps  
14.5cm/53/4" length

ES-191-14



Berry  
TC Heavy Sternal Needle Holder  
19cm/71/2" length

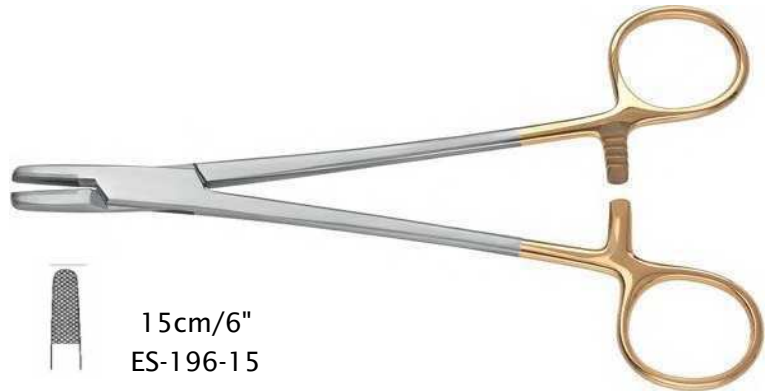

15cm/6"  
ES-190-15



15cm/6"  
ES-196-15



18cm/7"  
ES-190-18



18cm/7"  
ES-196-18



20cm/8"  
ES-190-20



20cm/8"  
ES-196-20

Berry  
TC Heavy Sternal Needle Holder  
With Drill  
18cm/7" length

ES-196-00



Mayo-Hegar  
Standard Needle Holder



ES-390-14  
14.5cm/5 3/4" length



ES-390-20  
20.5cm/8" length



ES-390-24  
24cm/7" length



ES-390-26  
26.5cm/9 1/2" length



ES-390-30  
30.5cm/12" length

Mayo-Hegar  
TC-Gold Needle Holder



ES-642-16  
16cm/6 1/4" length



ES-642-18  
18.5cm/7 1/4" length



ES-642-20  
20cm/8" length



ES-642-24  
24cm/7" length



ES-642-26  
26.5cm/9 1/2" length



ES-642-30  
30cm/11 3/4" length

Crowin Needle Holder  
TC Wire Holding Clamp/ Sternum  
16cm/6 1/4" length

ES-192-16

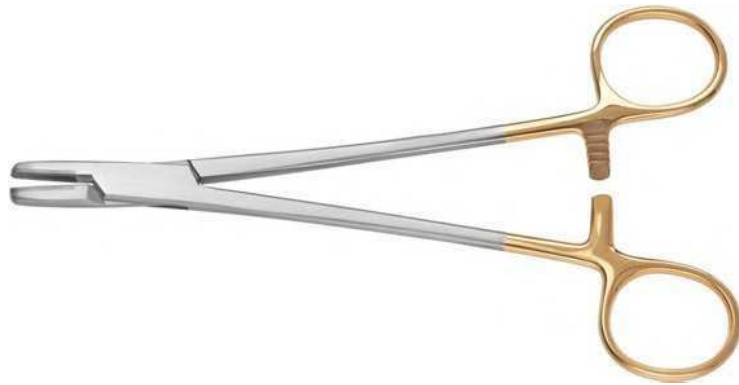

Crowin  
TC Wire Twister with drill  
16cm/6 1/4" length

ES-192-17



TC Wire Cutter  
12cm/4 3/4" length

ES-270-04

For Hard Wire  
Cuts wire up to 0.6mm Ø

For Soft Wire  
Cuts wire up to 1.0mm Ø



TC Wire Cutter  
14cm/5 1/2" length

ES-270-02

For Hard Wire  
Cuts wire up to 1.0mm Ø

For Soft Wire  
Cuts wire up to 1.5mm Ø



Harvey  
Tungsten carbide edges  
23.5cm/9" length

ES-222-23

For Hard Wire  
Cuts wire up to 2.2mm Ø

For Soft Wire  
Cuts wire up to 3mm Ø



Harvey  
Tungsten carbide edges  
23.5cm/9" length

ES-223-23

For Hard Wire  
Cuts wire up to 2.2mm Ø

For Soft Wire  
Cuts wire up to 3mm Ø



Reil  
Tungsten carbide edges  
17.5cm/63/4" length

ES-235-17

For Hard Wire  
Cuts wire up to 1.6mm Ø

For Soft Wire  
Cuts wire up to 2.0mm Ø



Tungsten carbide edges  
22cm/83/4" length

ES-237-22

For Hard Wire  
Cuts wire up to 2.2mm Ø

For Soft Wire  
Cuts wire up to 2.8mm Ø



Tungsten carbide edges  
18cm/7" length

ES-237-18

For Hard Wire  
Cuts wire up to 1.7mm Ø

For Soft Wire  
Cuts wire up to 2.0mm Ø



Tungsten carbide edges  
16cm/6 1/4" length

ES-237-16

For Hard Wire  
Cuts wire up to 1.7mm Ø

For Soft Wire  
Cuts wire up to 2.0mm Ø



Wire Cutters with T/C Jaws  
23cm/9" length  
Double action  
Cuts plates & wires up to 3.2mm Ø

ES-990-23



Wire Cutter  
18.5cm/7 1/4" length

ES-220-03

For Hard Wire  
Cuts wire up to 1.7mm Ø

For Soft Wire  
Cuts wire up to 2.0mm Ø

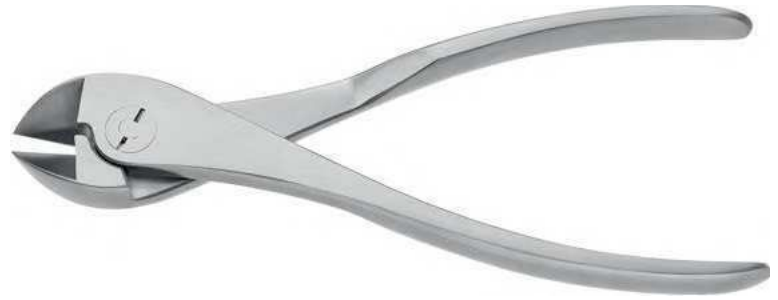

Tungsten Wire Cutter  
18.5cm/7 1/4" length

ES-225-03

For Hard Wire  
Cuts wire up to 1.7mm Ø

For Soft Wire  
Cuts wire up to 2.0mm Ø

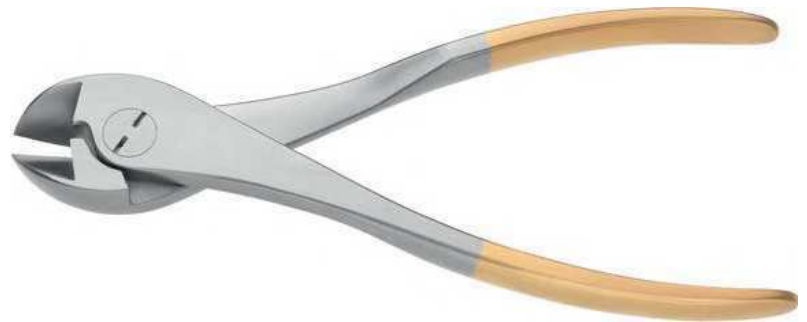

Head Cutters  
16cm/6 1/4" length  
Annulated

ES-230-16

For Hard Wire  
Cuts wire up to 1.8mm Ø

For Soft Wire  
Cuts wire up to 2.4mm Ø



Tungsten Wire Cutter  
14.5cm/5 3/4" length

ES-220-14

For Hard Wire  
Cuts wire up to 1.0mm Ø

For Soft Wire  
Cuts wire up to 1.5mm Ø





Martin-Diamant  
Wire Cutter, Front Action  
16cm/6 1/4" length

ES-232-16

For Hard Wire  
Cuts wire up to 2.0mm Ø

For Soft Wire  
Cuts wire up to 2.2mm Ø



TC Easy Cut Wire Cutter  
20cm/8" length

ES-832-20

For Hard Wire  
Cuts wire up to 2.2mm Ø

For Soft Wire  
Cuts wire up to 2.8mm Ø



TC Wire Cutter, Front, and Side  
Exchangeable TC Blades  
Cuts wire up to 1.6mm Ø  
With integrated rubber jaws  
18cm/7" length

ES-833-18



TC Wire Cutter, for right-hander  
Exchangeable TC Blades  
And Rubber Jaws  
Cuts wire up to 2.2mm Ø  
18cm/7" length

ES-834-18



TC Pin Cutter For K-Wires  
Up to 5mm  
46cm/183/4" length  
ES-998-46



54cm/211/4" length  
ES-998-54

TC Front Cutter  
40cm/1534" length  
For wires up to 4.7mm



ES-996-40

25cm/10" length  
For wires up to 3.2mm

ES-994-25

Pin Cutter for 6.35mm Steinmann pins  
With detachable handle  
57.5cm/221/2" length



ES-837-57

Pin Cutter Titanium  
Titanium Handles  
Hardened Cutting Edges  
54cm/21 1/4" length

ES-838-54

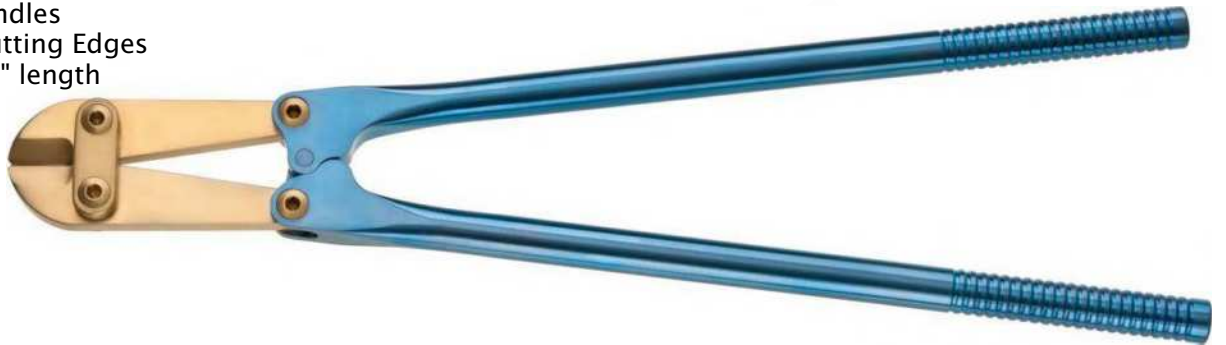

TC Pin Cutter



Code	Length	For wires
ES-999-38	38cm/15"	Ø 5.0mm
ES-999-45	45cm/17 3/4"	Ø 6.0mm
ES-999-56	56cm/22"	Ø 7.5mm

Wire Cutter K-Wire Up to 3mm  
32cm/12 3/4" length

ES-228-32



Harms  
TC Vertiberal Cutting Forcipes  
18cm/7" length

ES-839-18

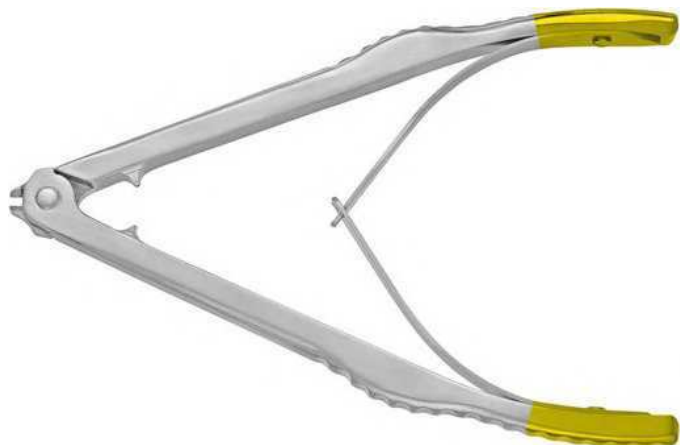

Crown and Collar Scissors  
10cm/4" length

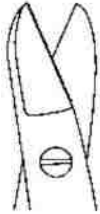
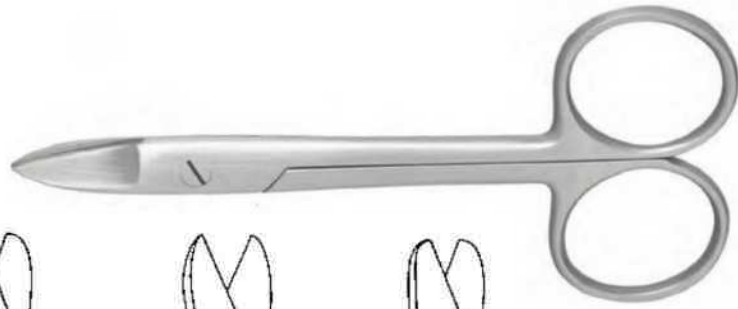

Straight, Sharp  
Serrated  
ES-840-01

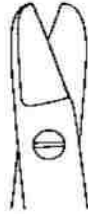

Straight, Blunt  
Serrated  
ES-840-02



Straight, Sharp  
ES-840-03



Straight, Blunt  
ES-840-04



Curved, Sharp  
Serrated  
ES-842-01



Curved, Blunt  
Serrated  
ES-842-02



Curved, Sharp  
ES-842-03



Curved, Blunt  
ES-842-04

Crown and Collar Scissors  
12cm/5" length

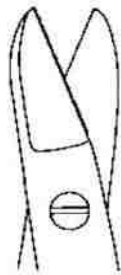

Straight, Sharp  
Serrated  
ES-841-01

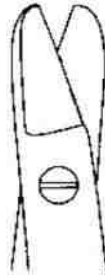

Straight, Blunt  
Serrated  
ES-841-02



Straight, Sharp  
ES-841-03

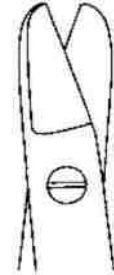

Straight, Blunt  
ES-841-04

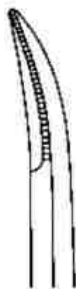

Curved, Sharp  
Serrated  
ES-843-01



Curved, Blunt  
Serrated  
ES-843-02



Curved, Sharp  
ES-843-03



Curved, Blunt  
ES-843-04

TC Wire Scissors  
Wire Cutter, Front Action  
12cm/43/4" length

ES-844-12

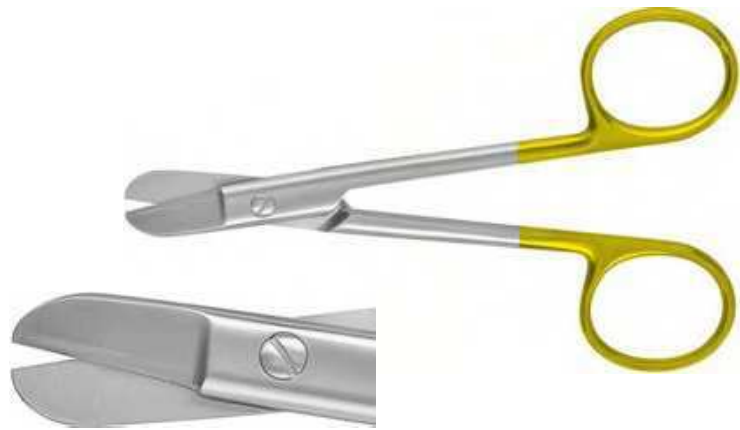

Smith  
TC Wire Cutting Scissors  
Serrated  
16cm/61/4" length

Straight ES-845-01  
Concave ES-845-02

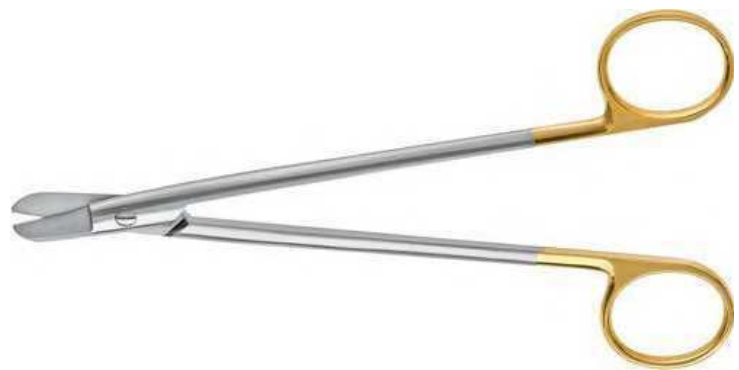

Schuknecht  
Wire Scissors, Straight  
Short Blades  
10cm/4" length

ES-846-10



TC Wire Twister and Scissors  
18cm/7" length

ES-194-18

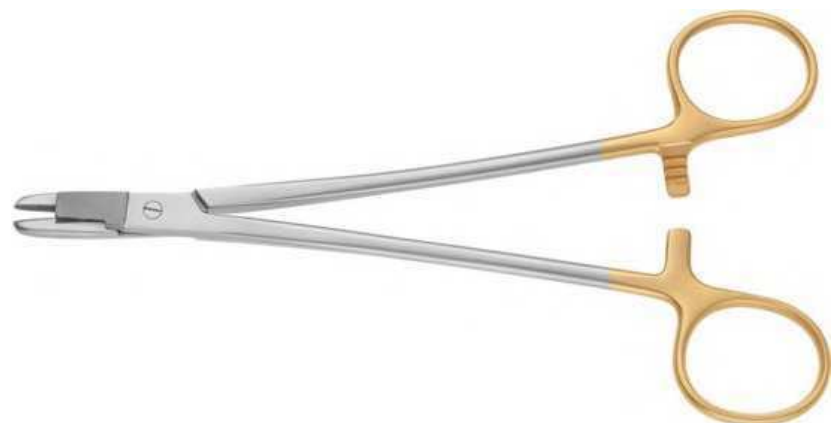

Baumgartner  
Wire Twisting Forceps, TO  
20cm/8" length

ES-202-20



Universal  
TC Wire and Plate Shear  
17cm/63/4" length

ES-848-17

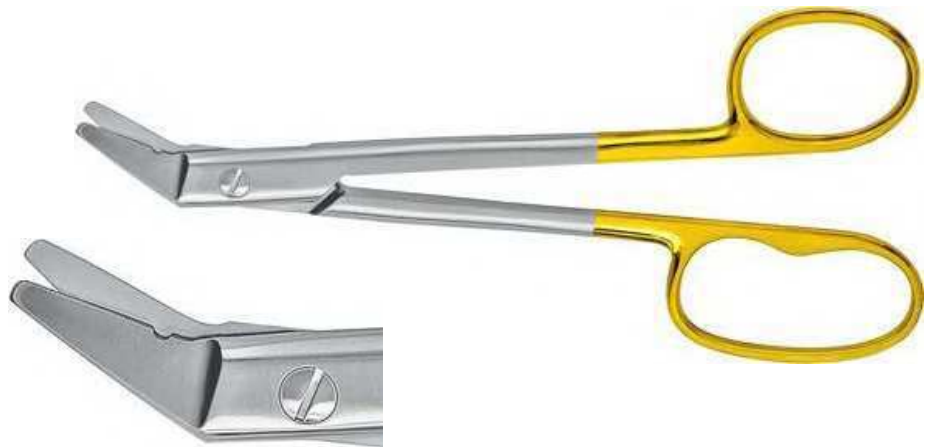

TC Universal Wire & Plate Scissors  
12cm/43/4" length

ES-849-12

For Hard Wire  
Cuts wire up to 0.8mm Ø

For Soft Wire  
Cuts wire up to 1.2mm Ø

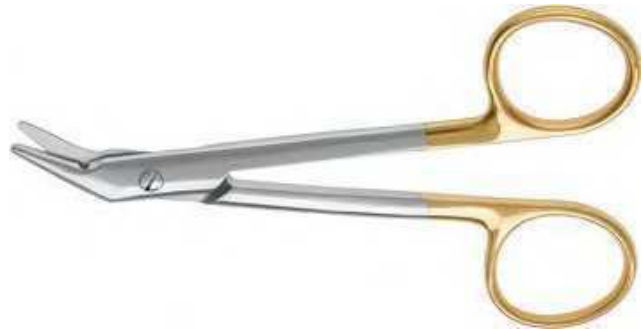

Flat Nose Plier  
with 3.5mm jaw  
16cm/61/4" length

ES-219-07



Needle Nosed Locking Pliers



Code	Length	
ES-852-22	22cm/8 3/4"	Small
ES-852-25	25cm/9 3/4"	Medium
ES-852-30	30cm/11 3/4"	Large

Pliers modified for Slap Hammer Code

Code	Length	
ES-853-22	22cm/8 3/4"	Small
ES-853-25	25cm/9 3/4"	Medium
ES-853-30	30cm/11 3/4"	Large

Slap Hammer attachment only

Code Length Weight

ES-852-00  
35cm/13 3/4" 400g\*

ES-853-00  
40cm/15 3/4" 700g+

+Fits pliers - small & medium size  
+Fits pliers - large size

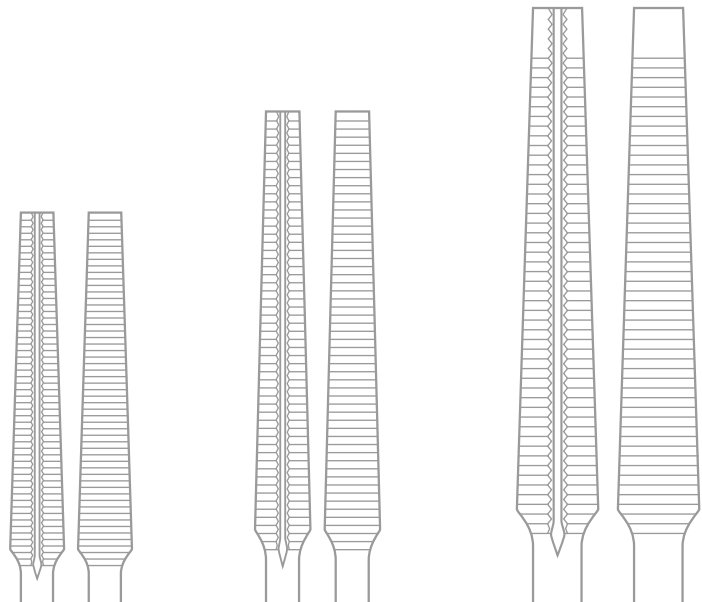

22cm/8 3/4" Small    25cm/9 3/4" Medium    30cm/11 3/4" Large



Orthopaedic Locking Pliers  
Hardened jaws

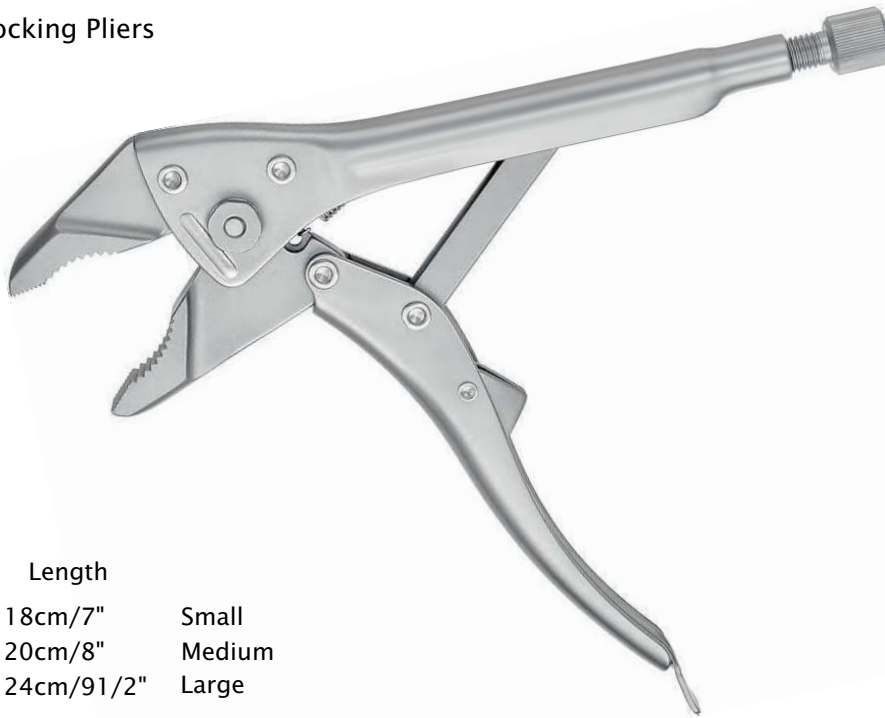

Code	Length	
ES-205-18	18cm/7"	Small
ES-205-20	20cm/8"	Medium
ES-205-24	24cm/9 1/2"	Large

Orthopaedic Locking Pliers modified for Slap Hammer

Code	Length	
ES-205-18	18cm/7"	Small
ES-205-20	20cm/8"	Medium
ES-205-24	24cm/9 1/2"	Large

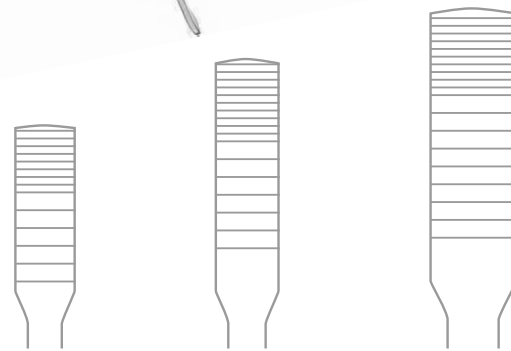

18cm/7" Small      20cm/8" Medium      24cm/9 1/2" Large

N.B. When used with slap hammer the locking pliers need modification.

Combined Wire Cutters & Pliers  
18cm/7" length  
Suitable for wires up to 1.6mm Ø  
Parallel closing jaws

ES-204-18





Wire Gripper  
Parallel Closure  
17cm/63/4" length

ES-203-17



Bending Plier, Alpha Plaet

8" For Plates up to 1.6mm  
16cm/61/4" length  
ES-970-16



93/4" For Plates up to 3.0mm  
25.5cm/10" length  
ES-972-25

Bending Press  
For plates upto 4.5mm  
40cm/16" length

ES-400-00



K-wire Applicator  
For K wire  $\varnothing$  0.8-1.6mm  
ES-855-10



Mini plate bending forceps  
For 1.5 and 2.0mm plates  
12.5cm/43/4" length

ES-856-12



K-wire and plate bending forceps  
For mini plates up to 1.6mm  
90° bending for k-wires  
14cm/43/4" length

ES-857-12



Steinmann  
Pin extractor for nails  
14cm/51/2" length  
upto 3.2mm

ES-858-14

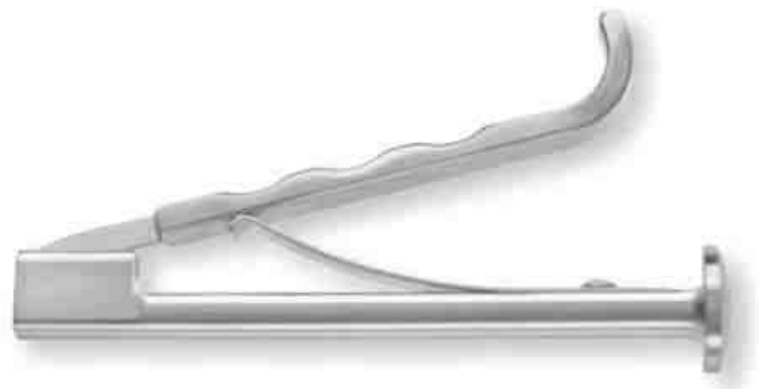

Wire and Pin bender  
15cm/6" length  
up to 3.2mm

ES-859-15



Wire Guide Instrument  
with ferrozell handle  
21cm/81/4" length

Ø 45mm  
ES-248-45

Ø 70mm  
ES-248-70



Demel  
Bone Wire Guide



Fig. 1  
ES-240-01  
28cm/11" length



Fig. 2.  
ES-240-02  
29cm/111/2" length



Fig.3  
ES-240-03  
31cm/121/2" length

Kronecker  
Ligature Needle,  
Right Angled  
15cm/6" length

ES-241-01



Kronecker  
Ligature Needle,  
Left Angled  
15cm/6" length

ES-241-02

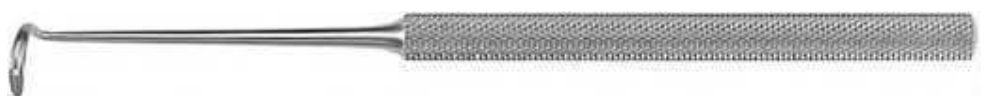

Weinraub  
Lamina Spreader  
with drill guide and ratchet  
18cm/7" length

ES-916-18



Bone Holding Forceps  
with guide for K-wire 1.8mm  
15cm/6" length

ES-917-15



Lepine  
Rod Bender, Adjustable  
For rods upto 7.0mm diameter  
28.5cm/11" length

ES-918-28



Bar Bending Plier  
For bar/wire Ø 3-4mm  
16cm/6 1/4" length

ES-918-16

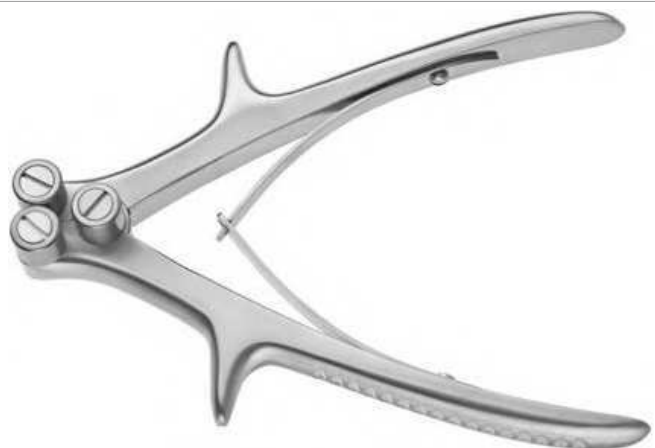

Demel  
Wire Tightening and  
Twisting Forceps  
28cm/11" length

ES-244-28

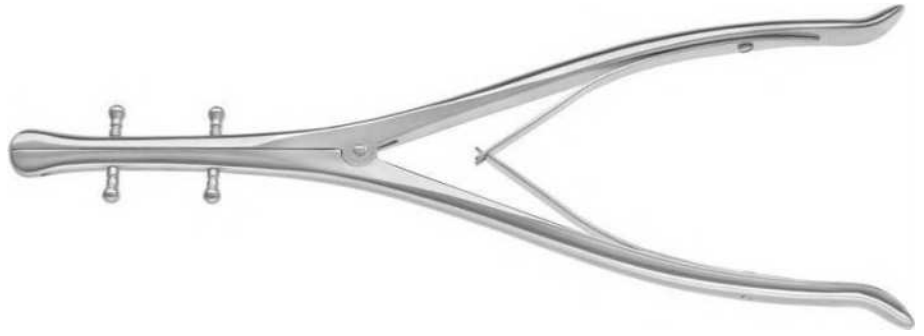

Wire Tightener  
With Double Wing Nut  
25cm/10" length

ES-870-02



ES-870-01

Loute  
Bone Wire Tightener  
21cm/8 1/4" length

ES-242-21



Wire Tightening Forceps  
With interchangeable head  
26cm/10 1/4" length

ES-928-26



**Kirschner  
With Three Traction Hooks  
1.5mm Ø wires**

Small Pattern/0-40mm  
ES-261-01  
18.5cm/7 1/4" length

Large Pattern/35-200mm  
ES-261-02  
27cm/11" length



**Bohler  
Extension Bow**

Code	hxb (cm)	
ES-255-16	16x9	For Arm
ES-255-21	21x11	For Thigh & Knee
ES-255-15	21x15	For Femur & Knee

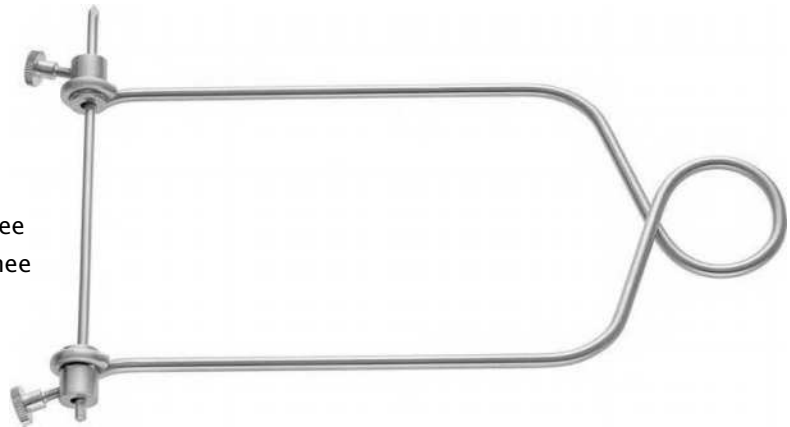

**Steinmann  
Trocar tip ©  
4mm Ø**

**Single Ended**

ES-250-14	140mm
ES-250-16	160mm
ES-250-18	180mm
ES-250-20	200mm

**Double Ended**

ES-252-16	Fig. 1
ES-252-19	Fig. 2
ES-252-22	Fig. 3

Single Ended

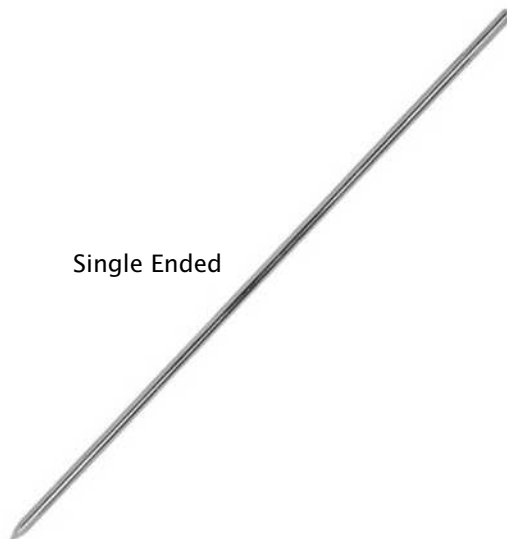

Kirschner  
Extension Bow  
Complete with three traction hooks

ES-263-18  
18x10cm

ES-263-27  
27x16cm



Kirschner  
Extension Bow For Knee  
Complete with three traction hooks

Code	cm
ES-265-01	9.5x7.0
ES-265-02	10.5x10.5
ES-265-03	12.0x12.0
ES-265-04	15.5x15.5
ES-265-05	20.0x15.5
ES-266-01	6.0x5.0
ES-266-02	9.5x11.0
ES-266-03	13.5x13.0



ES-267-03  
Small



ES-267-06  
Large

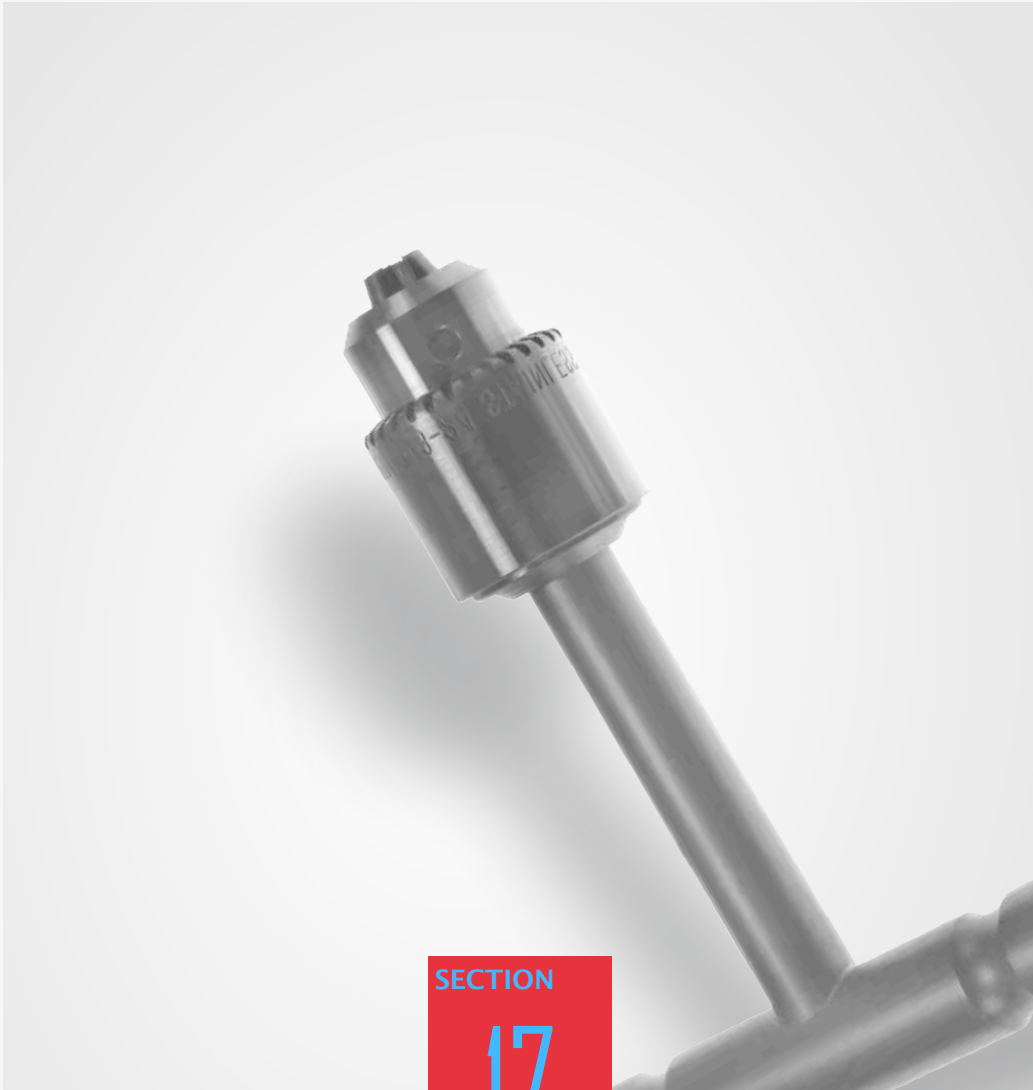

REAMERS, AWLS  
& HAND DRILLS



Perthes  
Reamer, Square  
21cm/8¼" length

ES-128-21

Reamer, Square  
18cm/7" length

ES-122-18



Awl With T-Handle  
14cm/5½" length

ES-126-14



Reamer, Ø 2.5-3.5mm  
14cm/5½" length

ES-128-14



Adson  
Bone Drill, Reamer  
15cm/6" length

ES-129-15

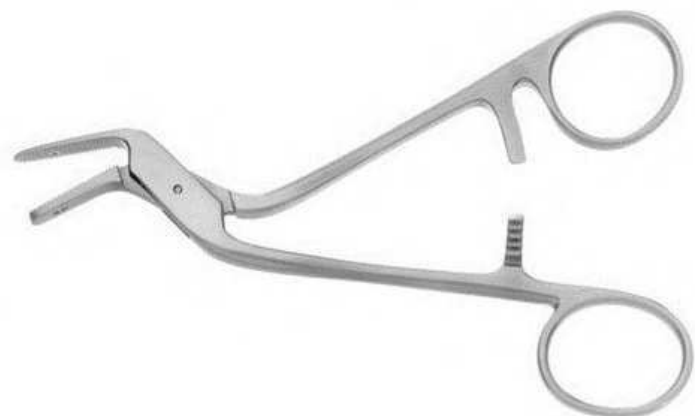

**Obwegesar, Awl**  
Reamer, Square  
23cm/9" length

ES-928-23



**Obwegesar, Awl**  
18cm/7" length

ES-929-18



**Brunner**  
Awl, Malleable  
23cm/9" length

ES-930-23



**Brunner**  
Awl, Curved  
30cm/11¾" length

ES-931-30



**Stille**  
20cm/8" length  
Complete, With Burrs



**Twills Drills**

- ES-186-02    Ø 2.5mm
- ES-186-03    Ø 3.0mm
- ES-186-04    Ø 3.5mm
- ES-186-10    Ø 4.0mm
- ES-186-11    Ø 1.0mm
- ES-186-12    Ø 1.5mm
- ES-186-01    Ø 2.0mm



**Round Burs**

- ES-186-07    Ø 8.0mm
- ES-186-08    Ø 12.0mm
- ES-186-09    Ø 16.0mm



ES-186-06  
Ø5.0mm



Ø10.0mm  
ES-186-05

**Stille Shermann**  
24cm/9½" length

ES-184-24



**Round Burs**

- ES-184-02    Ø 3.0mm
- ES-184-03    Ø 3.5mm
- ES-184-01    Ø 2.5mm

**Moore**

Complete with 3 drills

2 twist drills    ES-185-01

1 twist drill    ES-185-02

ES-185-24

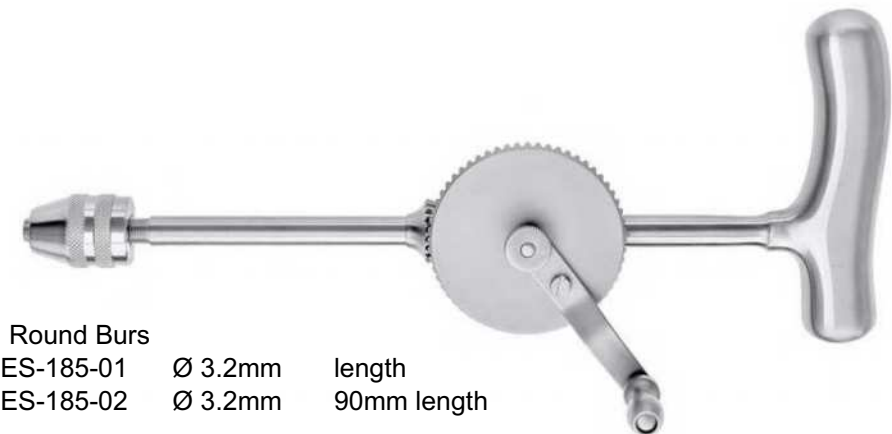

**Round Burs**

- ES-185-01    Ø 3.2mm    length
- ES-185-02    Ø 3.2mm    90mm length

**Bunnel**

Hand drill with adjustable handle  
with jacobs chuck

ES-188-01



**Bunnel**

Max shank Ø: 4.0mm  
16cm/6¼" length

ES-182-10



**Ralk**  
Hand drill with jacobs-chuk and key  
Ø 0-4mm

ES-182-00



**Ralk**  
Hand drill, Large with jacobs-chuk and key  
Ø 0-4mm

ES-182-01



**Smedberg Hand Drill**  
Complete with Three-jaw chuck

ES-182-02



ES-182-03

T-Handle Drill  
Stell chuck ind. key

HA517-12



T-Handle with jacobs-chuck  
12cm/4¾" length  
0.5mm - 4mm cannulated  
Ø 5.2mm ind. key

ES-188-02



T-Handle with universal-chuck  
14cm/5½" length  
1.0mm-6mm cannulated  
Ø 5.2mm

SP5507-14



T-Handle with Universal-chuck  
13cm/5" length  
1.0mm-6mm cannulated  
Ø 6.1mm  
With reverse lock, ind. key

SP5507-14



T-Handle with Roehm-chuck  
13cm/5" length  
0.5mm-7mm cannulated  
Ø 6.1mm, ind. key

SP5507-14



**Hudson  
Complete Set**

ES-181-00

**Brace, Extension**

ES-181-01



Hudson

27cm/10¾" length

ES-180-27



Ø 9mm

ES-180-01



Ø 14mm

ES-180-05



Hudson Tightening Screw  
Hand Drill only, with  
tightening screw

ES-181-01



Ø 9mm

ES-180-02



Ø 2mm

ES-180-06



Snap Hudson

Hand drill only, with nap lock

ES-180-16



Ø 16mm

ES-180-03



Ø 15mm

ES-180-10



Ø 22mm

ES-180-04



Ø 13mm

ES-180-07



Extension Piece

ES-180-09



Ø 16mm

ES-180-08

Handle Drill  
Stell chuck ind. key

HA519-12

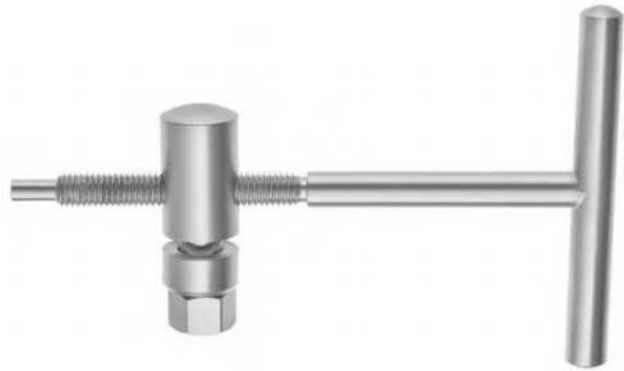

Key  
11mm

ES-816-11



Key  
14cm/5½" length

ES-817-01



Bending Iron  
14.5cm/6" length

use for 3.5 & 2.7mm plates  
ES-394-01

use for 2.7 & 3.5mm plates  
ES-394-02



Key  
13cm/5" length

ES-818-04



Michele  
Terphine  
18cm/7" length

Ø inside: 3mm  
Ø outside: 5mm ES-818-04

Ø inside: 5mm  
Ø outside: 6mm ES-818-04

Ø inside: 6.5mm  
Ø outside: 8mm ES-818-04





**Round Fitting Twist Drill**  
Stainless steel

Code	Diameter	Length	Flute
ES-149-11	1.1mm Ø	60mm	35mm
ES-149-15	1.5mm Ø	85mm	60mm
ES-149- 20	2.0mm Ø	100mm	75mm
ES-149- 25	2.5mm Ø	110mm	85mm
ES-149-27	2.7mm Ø	100mm	75mm
ES-149-32	3.2mm Ø	145mm	120mm
ES-149-35	3.5mm Ø	110mm	85mm
ES-149-45	4.5mm Ø	145mm	120mm
ES-149-60	6.0mm Ø	195mm	170mm

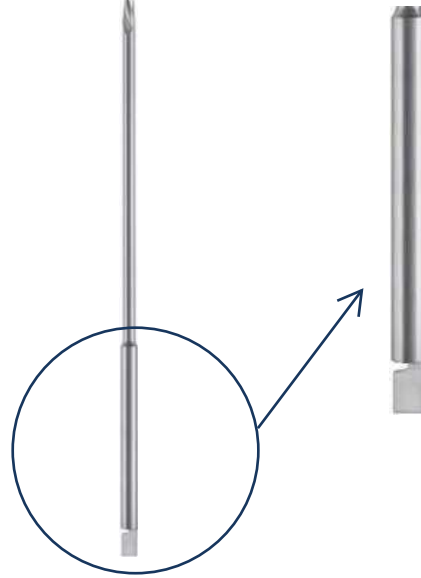

**AO Fitting Twist Drill**  
Stainless steel

Code	Diameter	Length	Flute
ES-149-11	1.1mm Ø	60mm	35mm
ES-149-15	1.5mm Ø	85mm	60mm
ES-149- 20	2.0mm Ø	100mm	75mm
ES-149- 25	2.5mm Ø	110mm	85mm
ES-149-27	2.7mm Ø	100mm	75mm
ES-149-32	3.2mm Ø	145mm	120mm
ES-149-35	3.5mm Ø	110mm	85mm
ES-149-45	4.5mm Ø	145mm	120mm
ES-149-60	6.0mm Ø	195mm	170mm



**AO Fitting Twist Tap**  
Stainless steel

Code	Diameter
ES-156-15	1.5mm Ø
ES-156-20	2.0mm Ø
ES-150-27	2.7mm Ø
ES-150-35	3.5mm Ø
ES-150-45	4.5mm Ø
ES-150-65	6.5mm Ø



**Femoral Head Extractor**  
23cm/9" length  
Tufnol handle



ES-529-23

**Slotted Mallet**



ES-210-30

**Kuntscher  
Bone Awl**  
26cm/10¼" length

	Width
ES-180-08	8mm
ES-180-10	10mm
ES-180-12	12mm



**Kuntscher  
Extraction Hook Handle**  
63cm/24¾" length



ES-186-63

Complete Set  
ES-186-00

Fig. 1  
ES-186-63

Fig. 2  
ES-186-63

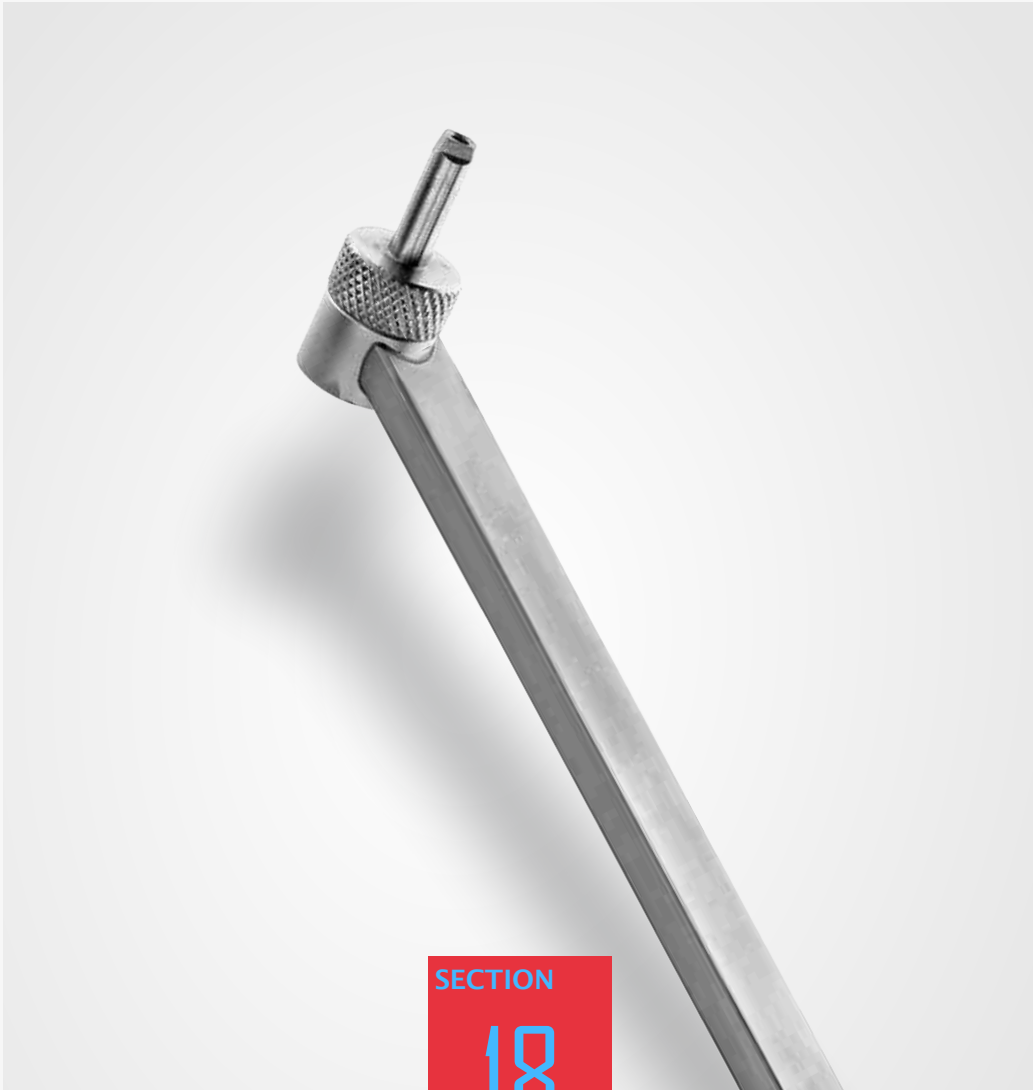

SECTION  
18

SCREW DRIVERS

**Frazier**

Aspiration Cannula  
19cm/7½" length



Code

- ES-938-06 6 Charr/2.0mm
- ES-938-08 8 Charr/2.5mm
- ES-938-10 10 Charr/3.0mm
- ES-938-12 12 Charr/4.0mm

**Ferguson**

Suction Cannula with finger  
18cm/7" length  
Cut-off and stylet



Code

- ES-939-06 6 Charr/2.0mm
- ES-939-08 8 Charr/2.5mm
- ES-939-10 10 Charr/3.0mm
- ES-939-12 12 Charr/4.0mm

**Baron**

Suction Cannula with finger  
Cut-off and stylet



75mm, 3" working length

- ES-940-03 3 Charr/1.0mm
- ES-940-05 5 Charr/1.8mm
- ES-940-07 7 Charr/2.3mm

100mm, 4" working length

- ES-941-03 3 Charr/1.0mm
- ES-941-05 5 Charr/1.8mm
- ES-941-07 7 Charr/2.3mm

**yankauer**

Suction tube with central drill  
withdive, Ø7.9mm  
27cm/10¾" length



Complete Instrument  
ES-942-27

Olive only, Ø7.9mm  
ES-942-00

Slotted Head  
17cm/6¾" length  
For head screws 2.7mm - 4.0mm

ES7014-17

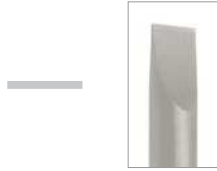

Long Slotted Head  
25cm/10" length  
For head screws 2.7mm - 4.0mm

ES7014-25



Phillips Head  
25cm/10" length  
For small Phillips head screws 6mm

ES7015-25

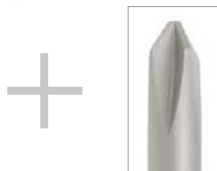

Cross Slotted Head  
25cm/10" length  
For cross slot screws 6mm

ES7016-25



Hexagonal Head  
25cm/10" length  
For hexagonal head screws 2.7mm - 4.0mm



Hexagonal ScrewDriver  
5mm

NF7026-02



Screwdriver Handle Small  
To fit shafts with quick lock attachment

NF7026-01



Shaft with Quick Lock Fitting  
Hexagonal tip

Shaft	Diameter
NF7026-00	2.5mm
NF7022-00	3.5mm



### Tap T-Handle

25cm/10" length

Shaft	
ES-500-35	3.5mm
ES-500-45	4.5mm
ES-500-70	7.0mm



### Cannulated Counter Sink

Shaft	
ES-600-11	1.1 mm For mini screws 1.5/2mm
ES-600-20	2.0mm For small screws 2.7/3.5/4mm
ES-600-32	3.2mm For malleolar screws 4.5mm



### Cannulated Counter Sink with T-Handle

For large screws 4.5/6.5mm  
4.5mm

ES-600-45



### Parallel Wire Guide

For guide Ø 2.0mm

ES-600-02



### Tissue Protector Sleeve

For cannulated screw Ø7.0mm

ES-610-07



### Tap & Drill Sleeve

ES-752-27 2.7/2.0mm  
ES-752-35 3.5/2.5mm



### Drill Sleeve

Double, 3.2/6.5mm  
ES-784-32

Double, 4.5/3.2mm  
ES-780-45



### Neutral drill guides

ES-840-20 2.0mm  
ES-840-27 2.7mm  
ES-840-35 3.5mm  
ES-840-45 4.5mm



### Triple Drill Guide Ø 2.0mm

ES-660-20





**Ferris-Smith-Kerrison**  
 Punch, non detachable  
 Cutting upward, 40°  
 18cm/7" length

Code	Jaw width
ES-978-17	2.0mm
ES-978-25	3.0mm
ES-978-33	4.0mm
ES-978-09	5.0mm
ES-978-41	6.0mm



**Ferris-Smith-Kerrison**  
 Cutting upward, 40°  
 18cm/7" length  
 Blackline Rongeur, Straight

Code	Jaw width
ES-979-25	4.0mm
ES-979-33	5.0mm
ES-979-41	6.0mm
ES-979-17	3.0mm
ES-979-09	2.0mm



**Ferris-Smith-Kerrison**  
Standard Rongeur, Bayonet  
Cutting upward, 40°  
18cm/7" length

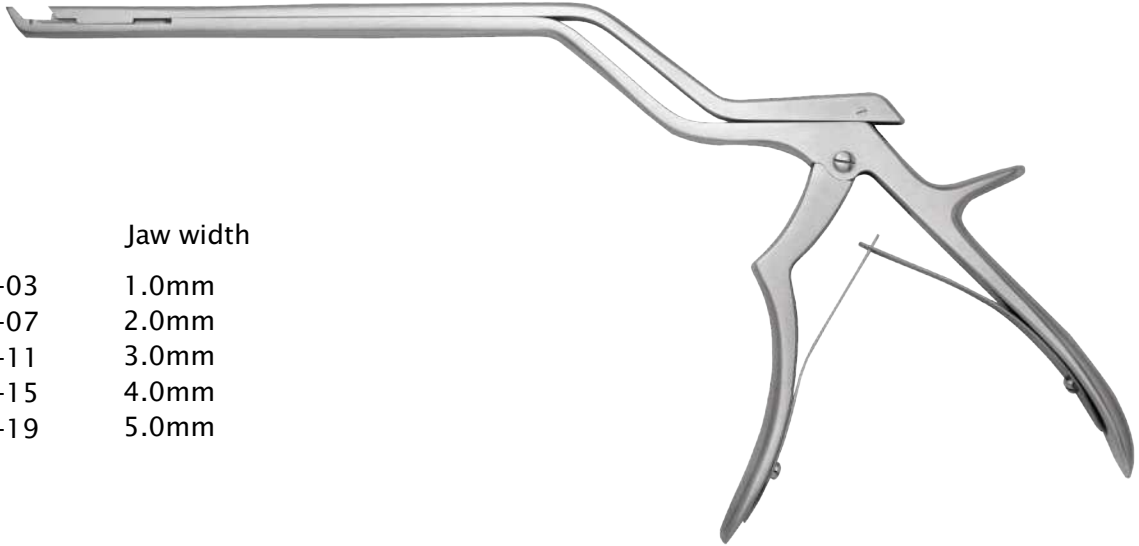
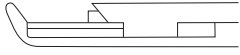

Code	Jaw width
ES-980-03	1.0mm
ES-980-07	2.0mm
ES-980-11	3.0mm
ES-980-15	4.0mm
ES-980-19	5.0mm

**Ferris-Smith-Kerrison**  
Blackline Rongeur, Bayonet  
Cutting upward, 40°  
18cm/7" length

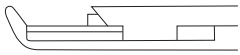

Code	Jaw width
ES-980-03	1.0mm
ES-980-07	2.0mm
ES-980-11	3.0mm
ES-980-15	4.0mm
ES-980-19	5.0mm

**Metzenbaum**  
Standard Scissors  
Curved  
18cm/7" length

ES-285-18



**Mayo**  
Dissecting Scissors  
Straight  
14cm/5½" length

ES-170-14

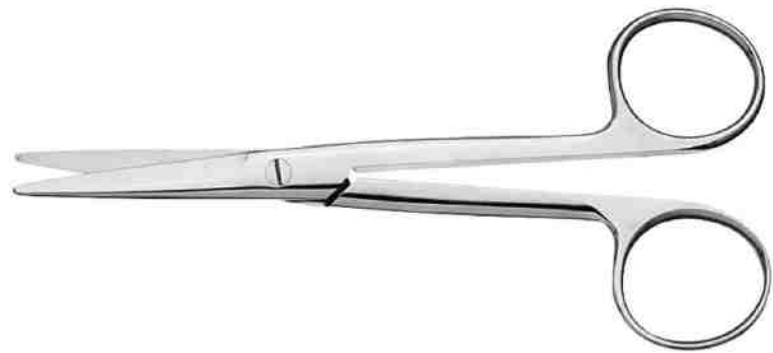

**Adventitia**  
Micro Scissors, 8mm diameter

15cm/6" length

Straight, 9mm Blade  
EM306GN

Curved, 9mm Blade  
EM309GN

