

2025

SPINE SURGERY CATALOGUE

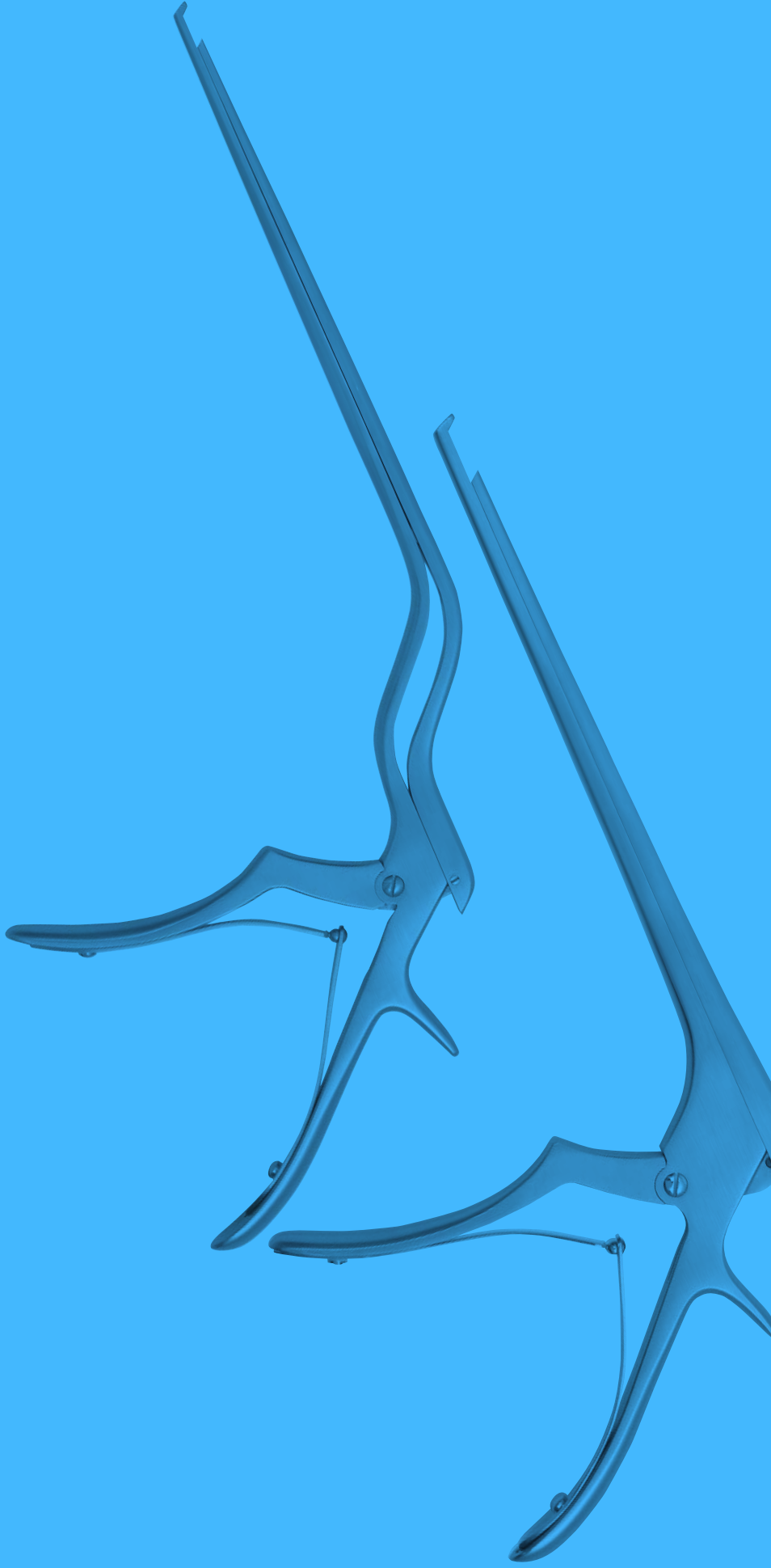

 **instrument**
Superior Quality, Trusted Precision



WE

ZULFIQAR SURGICAL is known for its quality For Surgical instruments and Instruments for surgery and is an operated business that has been dedicated to providing healthcare professionals with the products they need to perform their art since a long. Our high quality, precision crafted instruments have been an essential product line to our worthy customers. We carry an exclusive range of Surgical Instruments, Surgical Instruments and Healthcare Equipments.

We are committed to providing a product line that guarantees quality and extraordinary value to the end user as well as a level of service, satisfaction, and cooperation that has become a hallmark of Eco Surgical. We have gained a reputation for offering unbeatable prices on branded items as well as outstanding customer service on all levels. Every single instrument is manufactured with great care. We are working hard for maintaining higher standard. Advanced techniques are used in manufacturing and finishing departments in order to make best products.

ZULFIQAR SURGICAL is offering you huge selection of our products and much more for a fast growing number of customers. We make it easy for you to browse our products, place orders and benefit from our quality services.

We assure you quality instruments, most competitive prices and shortest delivery time.

All Instruments are available in a high-polish or satin/matte finish according to individual preferences. Constructed from high-quality 300, 410, or 420 Series Stainless Steel, these devices meet or exceed all ASTM/AISI International Standards for Medical Device production. Undergoing the latest finishing techniques to prevent rusting and future corrosion, our state-of-the-art method includes, but is not limited to: surface grinding, broaching, heat treating, drilling, tapping, electronically passivating and I.D./O.D. Threading.

Content

Page

Neurosurgery, Laminectomy	01-38
Arthroscopy	39-62
Otology	63-83
Gynecology, Obstetrics	84-90
Rhinology	91-99
Oral maxillo-facial surgery	100-104



instrument

Superior Quality, Trusted Precision

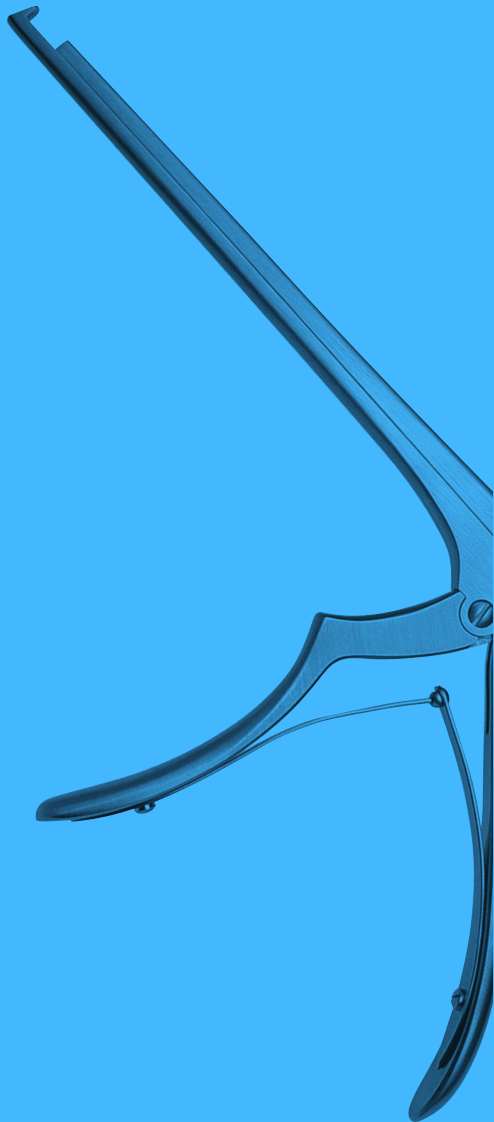

Neurochirurgie, Laminektomie

Neurosurgery, Laminectomy

Neurocirugía, Laminectomía

Neurochirurgia, Laminectomia

Nervwurzelhaken

Nerve root retractors

Separadores para la raíz de nervios

Seperatori pr le radici dei nervi



Scoville

NEU-140-230 23,0 cm / 9"



Scoville

NEU-141-200 20,0 cm / 8"

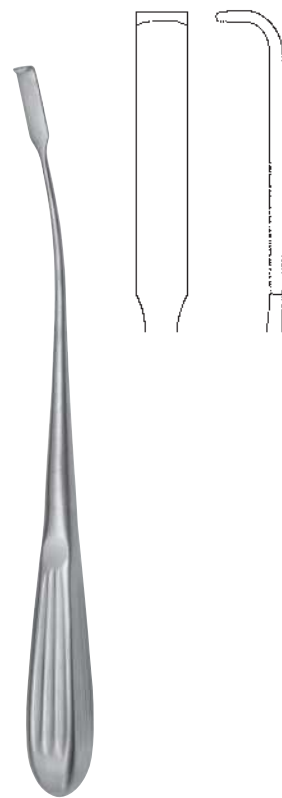

Holsher

NEU-143-240 24,0 cm / 9½"



Love

NEU-146-190 19,0 cm / 7½"

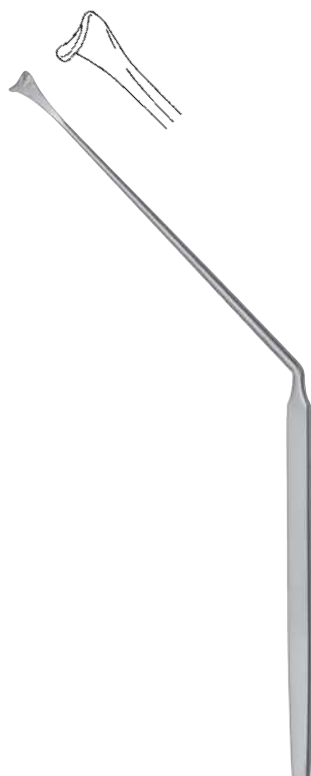

Love

NEU-147-180 18,0 cm / 7"

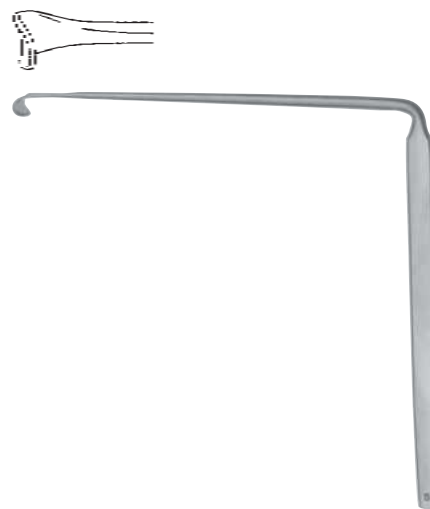

Love

NEU-149-140 14,0 cm / 5½"

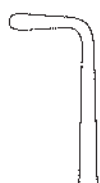

NEU-153-001



NEU-153-002

Groningen

NEU-153-001 - NEU-153-002 26,0 cm / 10¹/₄"



stumpf
blunt
romo
smusso

Cushing

NEU-155-190 19,0 cm / 7¹/₂"
NEU-155-280 28,0 cm / 11"



stumpf
blunt
romo
smusso

Cushing

NEU-157-190 19,0 cm / 7¹/₂"
NEU-157-280 28,0 cm / 11"



Dandy
 NEU-159-200 20,0 cm / 8¹/₂"

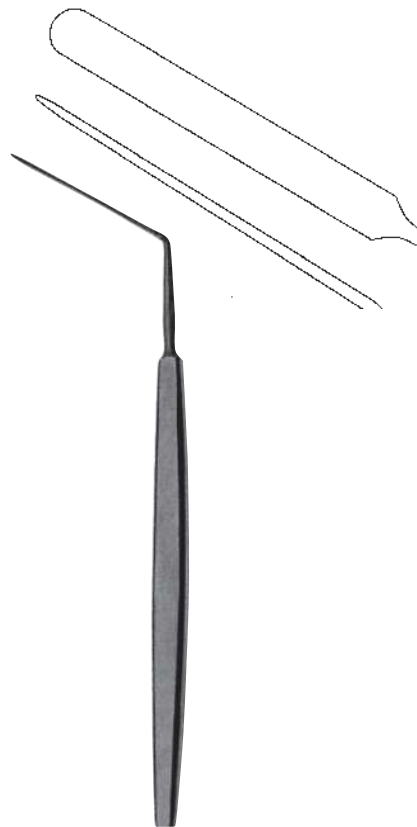

Horsley
 NEU-161-200 20,0 cm / 7¹/₄"



Sachs
 NEU-163-210 21,0 cm / 9"



scharf
sharp
 agudo
 acuto

Sachs
 NEU-165-210 21,0 cm / 8"
 ZSINSTRUMENT.COM

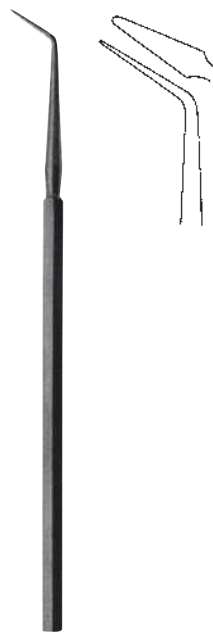

Frazier
 NEU-167-165 16,5 cm / 6¹/₂"



Milligan
 NEU-169-210 21,0 cm / 8¹/₄"



Davis

NEU-170-245 24,5 cm / 9²/₈"



Penfield

NEU-171-001 17,5 cm / 7"



Penfield

NEU-171-002 19,5 cm / 7³/₄"



Penfield

NEU-171-003 19,5 cm / 7³/₄"



Penfield

NEU-171-215 21,5 cm / 8¹/₂"



Penfield

NEU-171-290 29,0 cm / 11¹/₂"
 ZSINSTRUMENT.COM

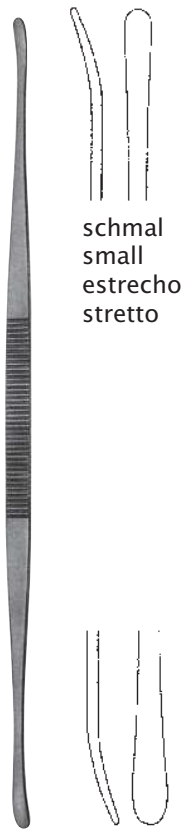

schmal
 small
 estrecho
 stretto

Toennis

NEU-173-001 24,0 cm / 9½"



breit
 large
 ancho
 largo

Toennis

NEU-173-002 24,0 cm / 9½"

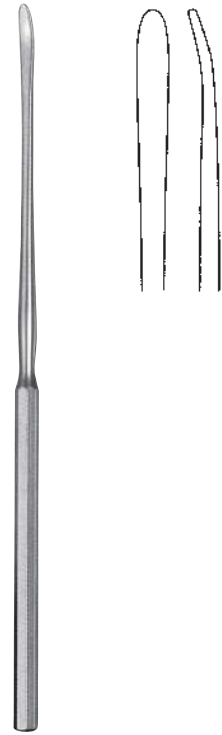

Davis

NEU-175-190 19,0 cm / 7½"



schmall
 small
 estrecho
 stretto

Olivecrona

NEU-177-180 18,0 cm / 7"
 NEU-177-240 24,0 cm / 9½"



breit
 large
 ancho
 largo

Olivecrona

NEU-179-195 19,5 cm / 7¾"
 NEU-179-240 24,0 cm / 9½"

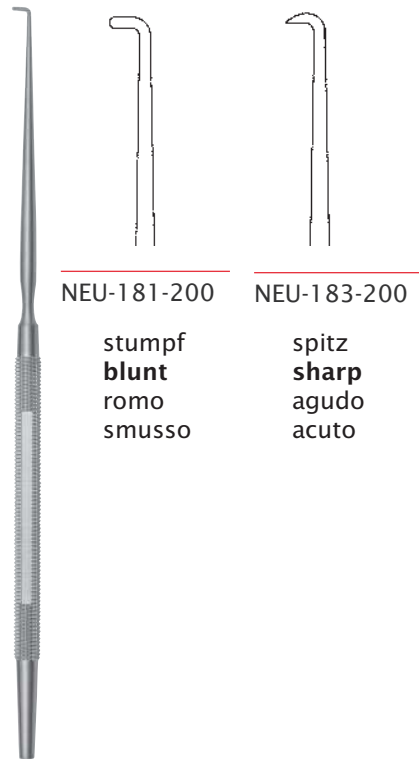

NEU-181-200

NEU-183-200

stumpf
blunt
romo
smusso

spitz
sharp
agudo
acuto

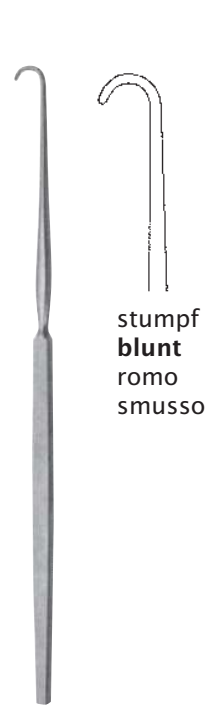

stumpf
blunt
romo
smusso



spitz
sharp
agudo
acuto

Adson

NEU-181-200 - NEU-183-200 20,0 cm / 8"

Graham

NEU-185-165 16,5 cm / 6³/₄"

Sachs

NEU-187-185 18,5 cm / 7¹/₄"



spitz
sharp
agudo
acuto



stumpf
blunt
romo
smusso



Frazier

NEU-189-130 13,0 cm / 5"
NEU-189-180 18,0 cm / 7"

Frazier

NEU-190-130 13,0 cm / 5"

Cushing

NEU-191-140 14,0 cm / 5¹/₂"

Duramesser, Durahaken
Dura Knives, Dura hooks

cuchillos para duramadre, ganchos para duramadre
bisturi per dura-madre, uncini per dura-madre



Toennis

NEU-193-130 13,0 cm / 5 1/8"



Toennis

NEU-193-190 19,0 cm / 7 1/2"



Halle

NEU-195-200 20,0 cm / 8 1/4"



Caspar

NEU-201-001 - NEU-201-004 25,0 cm / 10"



NEU-201-001



NEU-201-002



NEU-201-003



NEU-201-004



Krayenbühl

NEU-203-020 - NEU-203-035 18,5 cm / 7 1/4"



NEU-203-020



NEU-203-025



NEU-203-030



NEU-203-035



Spekula für trans-sphenoidale Hypophysectomie
Specula for trans-sphenoidal hypophysectomy
Espéculo para la hipofisectomía trans-sfenoidal
Speculo per ipofisectomia trans-sfenoidale

**Landolt-
Cushing**

NEU-210-070 Ø 15 mm x 70 mm
NEU-210-090 Ø 15 mm x 90 mm

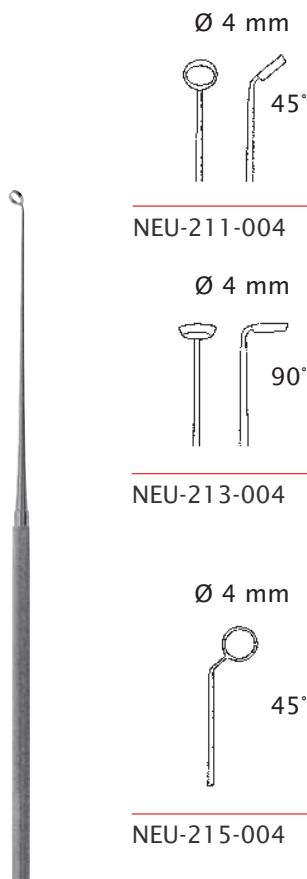

Ray

NEU-211-004 - NEU-215-004 19,0 cm / 7 1/2"

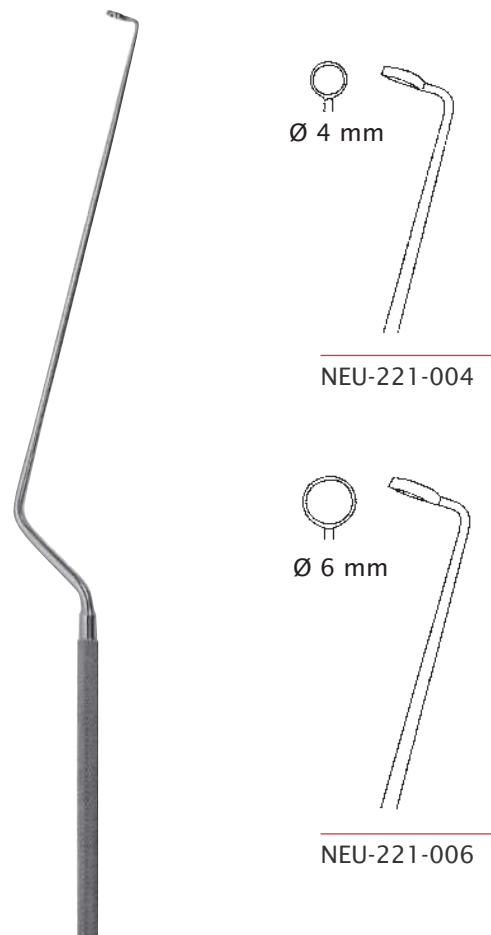

Hardy

NEU-221-004 - NEU-221-006 26,0 cm / 10 1/4"

Küretten, horizontal 90°, biegsam
Curettes, horizontal 90°, malleable
Curetas, horizontal 90°, maleable
Curette, orizzontale 90°, malleabile

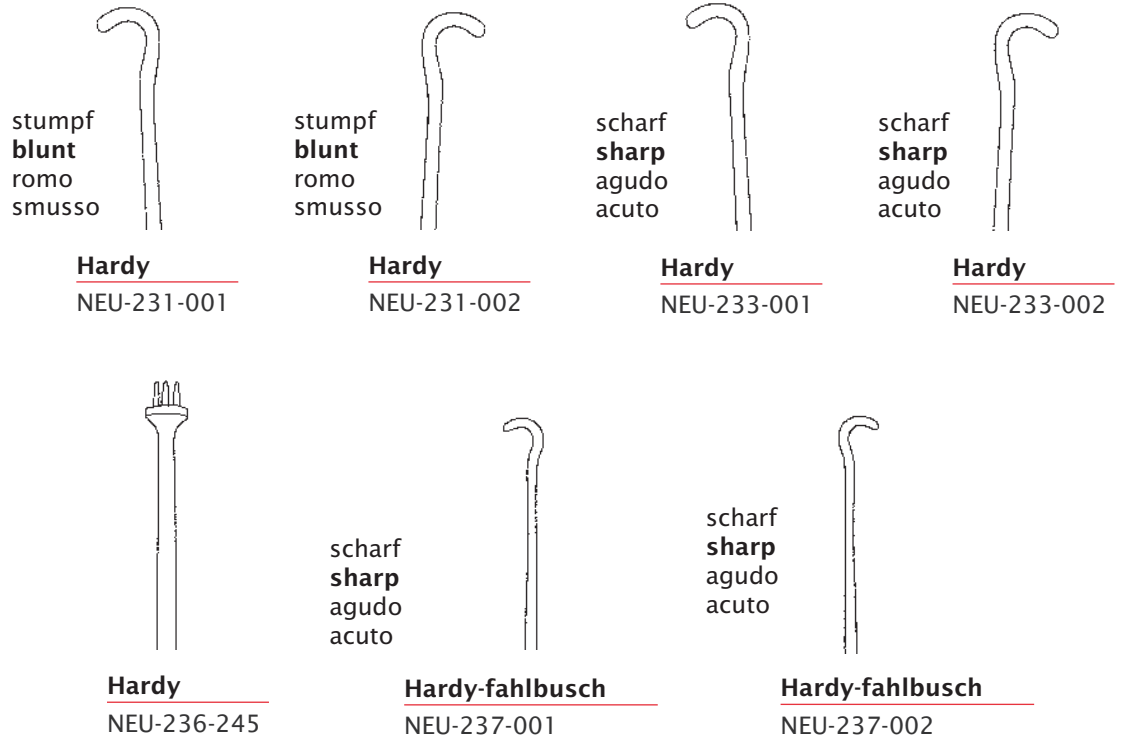

stumpf
blunt
 romo
 smusso

Hardy
 NEU-231-001

stumpf
blunt
 romo
 smusso

Hardy
 NEU-231-002

scharf
sharp
 agudo
 acuto

Hardy
 NEU-233-001

scharf
sharp
 agudo
 acuto

Hardy
 NEU-233-002



Hardy
 NEU-236-245

scharf
sharp
 agudo
 acuto

Hardy-fahlbusch
 NEU-237-001

scharf
sharp
 agudo
 acuto

Hardy-fahlbusch
 NEU-237-002

NEU-231-001 - NEU-237-002 24,5 cm / 9 3/4"

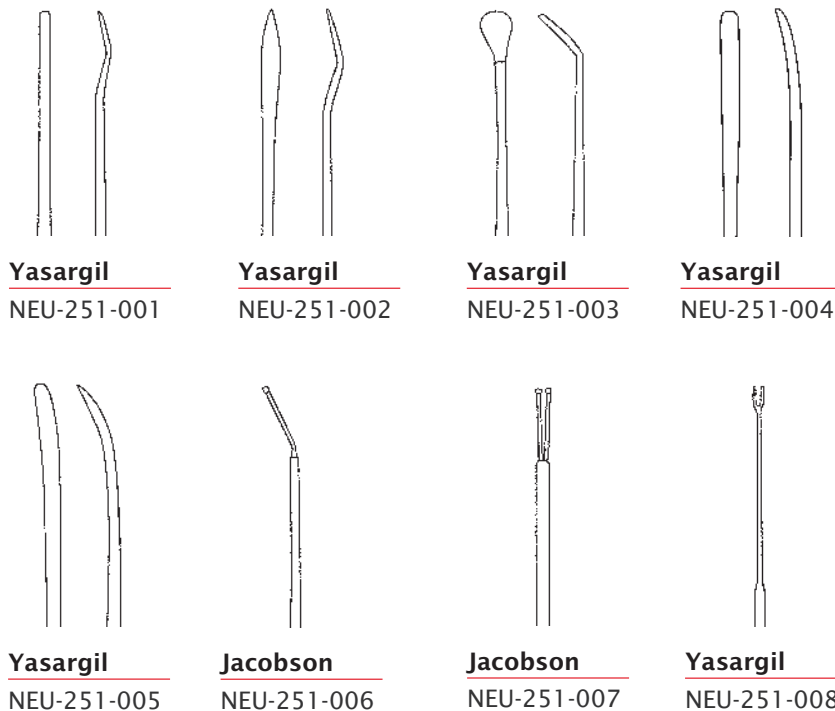

Yasargil
 NEU-251-001

Yasargil
 NEU-251-002

Yasargil
 NEU-251-003

Yasargil
 NEU-251-004

Yasargil
 NEU-251-005

Jacobson
 NEU-251-006

Jacobson
 NEU-251-007

Yasargil
 NEU-251-008

NEU-251-001 - NEU-251-008 19,0 cm / 7 1/2"

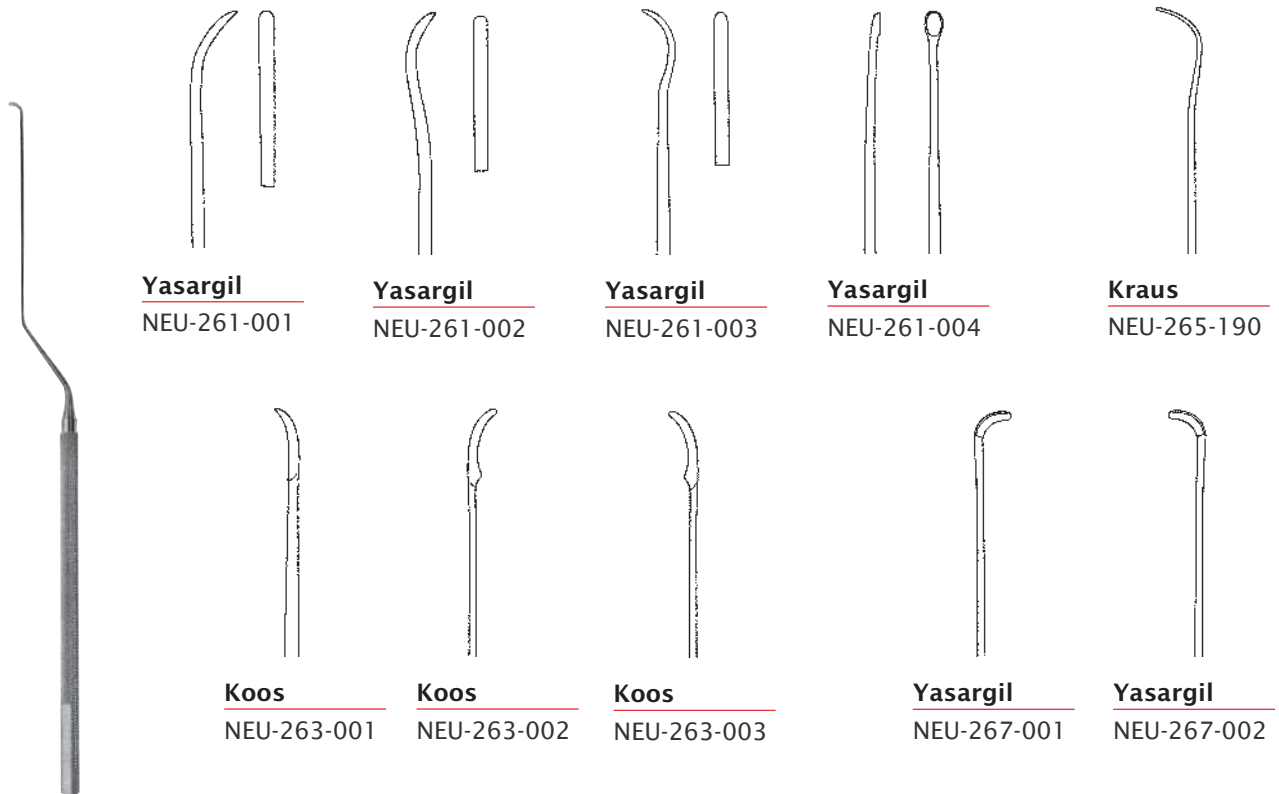

NEU-261-001 - NEU-267-002 19,0 cm / 7 1/4"

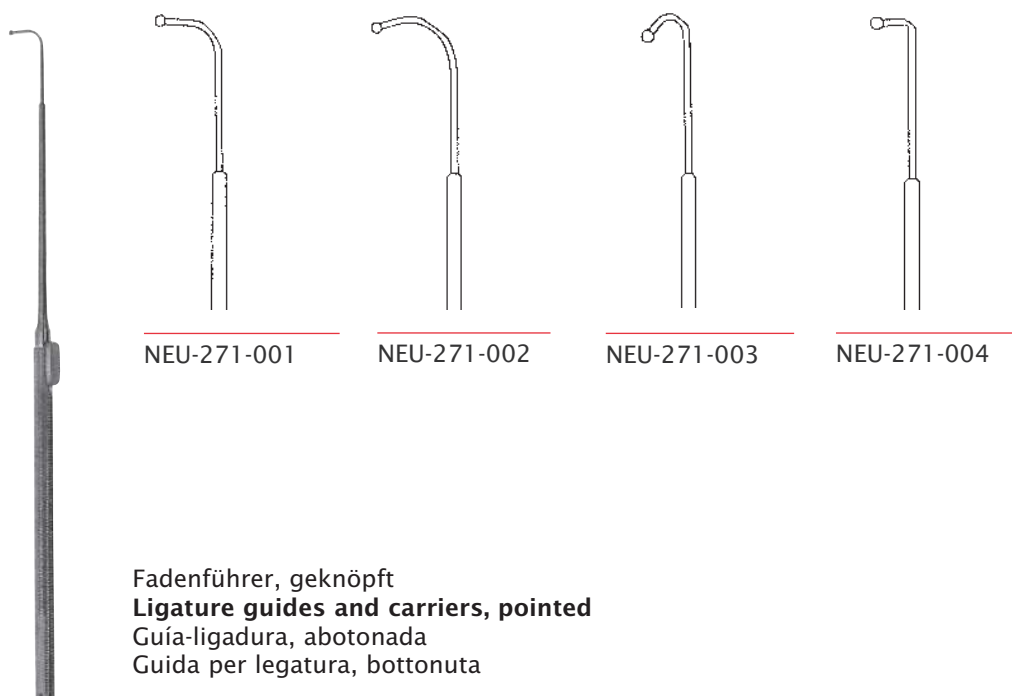

Fadenführer, geknöpft
Ligature guides and carriers, pointed
Guía-ligadura, abotonada
Guida per legatura, bottonuta

Yasargil

NEU-271-001 - NEU-271-004 18,5 cm / 7 1/4"



NEU-280-001



NEU-280-002



NEU-291-001

Dissektor
Dissector
 Discador
 Dissettore



NEU-281-001

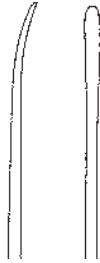

NEU-281-002



NEU-291-002

Dissektor
Dissector
 Discador
 Dissettore

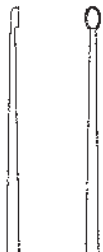

NEU-284-001

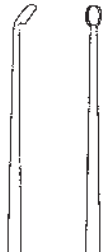

NEU-284-002



NEU-291-003

Raspatorium
Raspatory
 Legra
 Periostotomo



NEU-285-001



NEU-285-002



NEU-280-001 - NEU-285-002 23,0 cm / 9"

NEU-291-001 - NEU-291-003 23,0 cm / 9"

Schaft Ø 1,0 mm
shaft 1,00 diam.
Vástago de 1,0 mm de Ø
Ø dell'asta mm 1,0

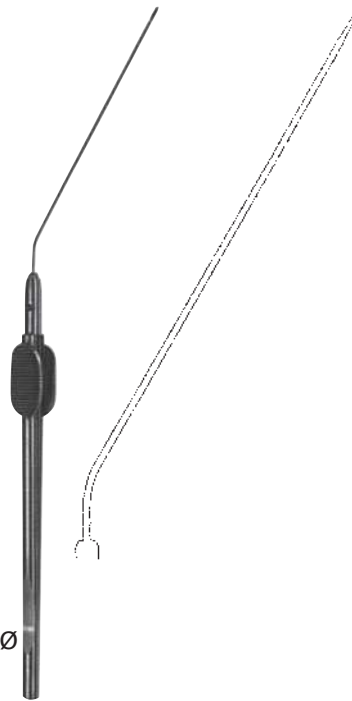

NEU-331-190



NEU-333-190



NEU-335-190



NEU-337-190



NEU-339-190

NEU-331-190 - NEU-339-190 19,0 cm / 7 1/2"

Schaft Ø 1,0 mm
shaft 1,00 diam.
Vástago de 1,0 mm de Ø
Ø dell'asta mm 1,0

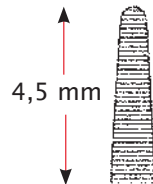
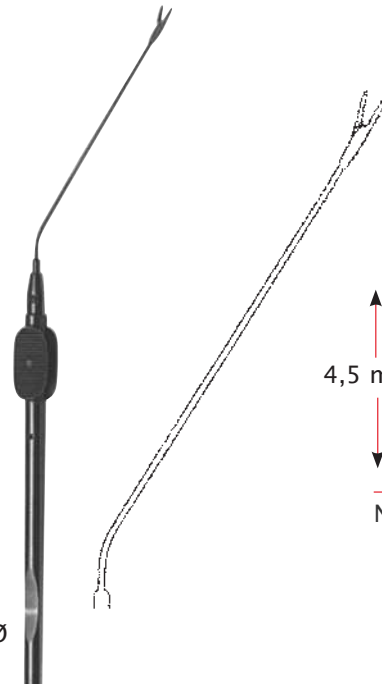

NEU-341-190



NEU-343-190

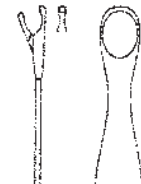

NEU-345-190

NEU-341-190 - NEU-345-190 19,0 cm / 7 1/2"

wirbelkörperspreizer

Lamina Spreaders

Separadores para cuerpos vertebrales

Separatori per vertebre

Spreizweite 18 mm
Blade opening 18 mm
Abertura de la hoja 18 mm
Apertura lame 18 mm



Cloward

NEU-491-130 13,0 cm / 5¹/₈"

Spreizweite 18 mm
Blade opening 18 mm
Abertura de la hoja 18 mm
Apertura lame 18 mm



Cloward

NEU-493-160 16,0 cm / 6¹/₄"

Spreizweite 38 mm
Blade opening 38 mm
Abertura de la hoja 38 mm
Apertura lame 38 mm



Inge

NEU-495-160 16,0 cm / 6¹/₄"



Inge

NEU-497-270 27,0 cm / 10¹/₂"



Kleiner Griff
Small handle
Mango pequeño
Manico piccolo

Kerrison

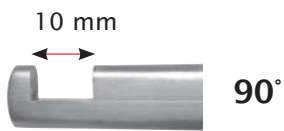

Schaftlänge Length of shaft Longitud del vástago Lunghezza dell`asta	Bissbreite / Width of bite / Anchura de la boca / Larghezza del morso					
	1 mm	2 mm	3 mm	4 mm	5 mm	6 mm
180 mm	NEU-550-001	NEU-550-002	NEU-550-003	NEU-550-004	NEU-550-005	NEU-550-006
200 mm	NEU-552-001	NEU-552-002	NEU-552-003	NEU-552-004	NEU-552-005	NEU-552-006
230 mm	-	NEU-554-002	NEU-554-003	NEU-554-004	NEU-554-005	-

Dünnfuß (Mikro)
Thin footplate (Micro)
 Lámin de punzonar estrecha (Micro)
 Battente sottile (Micro)



Kleiner Griff
Small handle
 Mango pequeno
 Manico piccolo

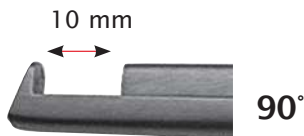

Kerrison

Schaftlänge Length of shaft Longitud del vástago Lunghezza dell`asta	Bissbreite / Width of bite / Anchura de la boca / Larghezza del morso				
	2 mm	3 mm	4 mm	5 mm	6 mm
180 mm	NEU-560-002	NEU-560-003	NEU-560-004	NEU-560-005	NEU-560-006
200 mm	NEU-562-002	NEU-562-003	NEU-562-004	NEU-562-005	NEU-562-006
230 mm	NEU-564-002	NEU-564-003	NEU-564-004	NEU-564-005	-



Kerrison

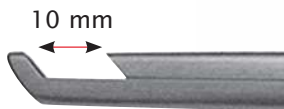

Schaftlänge Length of shaft Longitud del vástago Lunghezza dell`asta	Bissbreite / Width of bite / Anchura de la boca / Larghezza del morso					
	1 mm	2 mm	3 mm	4 mm	5 mm	6 mm
180 mm	NEU-570-001	NEU-570-002	NEU-570-003	NEU-570-004	NEU-570-005	NEU-570-006
200 mm	NEU-572-001	NEU-572-002	NEU-572-003	NEU-572-004	NEU-572-005	NEU-572-006
230 mm	-	NEU-574-002	NEU-574-003	NEU-574-004	NEU-574-005	-

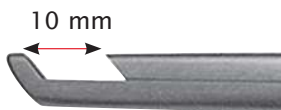

130° (40°)

mit Auswerfer
with ejector
con espulsore
con espulsore

Schaftlänge Length of shaft Longitud del vástago Lunghezza dell`asta	Bissbreite / Width of bite / Anchura de la boca / Larghezza del morso		
	3 mm	4 mm	5 mm
180 mm	NEU-580-003	NEU-580-004	NEU-580-005
200 mm	NEU-582-003	NEU-582-004	NEU-582-005

Laminektomie-Stanzen
Laminectomy Punches

Pinzas cortantes para laminectomia
 Pinze per laminectomia

nicht zerlegbar
non detachable
 non desmontable
 non smontabile



Dünnfuß (Mikro)
Thin footplate (Micro)
 Lamina de punzonar estrecha (Micro)
 Battente sottile (Micro)

Kleiner Griff
Small handle
 Mango pequeño
 Manico piccolo

Kerrison

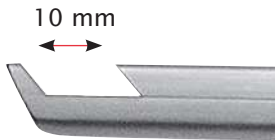

130° (40°)

Schaftlänge Length of shaft Longitud del vástago Lunghezza dell`asta	Bissbreite / Width of bite / Anchura de la boca / Larghezza del morso				
	2 mm	3 mm	4 mm	5 mm	6 mm
180 mm	NEU-590-002	NEU-590-003	NEU-590-004	NEU-590-005	NEU-590-006
200 mm	NEU-592-002	NEU-592-003	NEU-592-004	NEU-592-005	NEU-592-006
230 mm	NEU-594-002	NEU-594-003	NEU-594-004	NEU-594-005	-

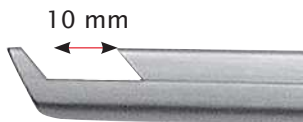

130° (40°)

mit Auswerfer
with ejector
 con expulsor
 con espulsore

Schaftlänge Length of shaft Longitud del vástago Lunghezza dell`asta	Bissbreite / Width of bite / Anchura de la boca / Larghezza del morso		
	3 mm	4 mm	5 mm
180 mm	NEU-600-003	NEU-600-004	NEU-600-005
200 mm	NEU-602-003	NEU-602-004	NEU-602-005



Kleiner Griff
Small handle
Mango pegueno
Manico piccolo

Kerrison



Standardfuß
Standard footplate
Lámin de punzonar standard
Battente standard

Schaftlänge Length of shaft Longitud del vástago Lunghezza dell`asta	Bissbreite / Width of bite / Anchura de la boca / Larghezza del morso			
	2 mm	3 mm	4 mm	5 mm
180 mm	NEU-610-002	NEU-610-003	NEU-610-004	NEU-610-005
200 mm	NEU-612-002	NEU-612-003	NEU-612-004	NEU-612-005



Dünnfuß (Mikro)
Thin footplate (Micro)
Lámina de punzonar estrecha (Micro)
Battente sottile

Schaftlänge Length of shaft Longitud del vástago Lunghezza dell`asta	Bissbreite / Width of bite / Anchura de la boca / Larghezza del morso			
	2 mm	3 mm	4 mm	5 mm
180 mm	NEU-620-002	NEU-620-003	NEU-620-004	NEU-620-005
200 mm	NEU-622-002	NEU-622-003	NEU-622-004	NEU-622-005

Laminektomie-Stanzen
Laminectomy Punches

Pinzas cortantes para laminectomia
 Pinze per laminectomia

nicht zerlegbar
non detachable
 non smontabile

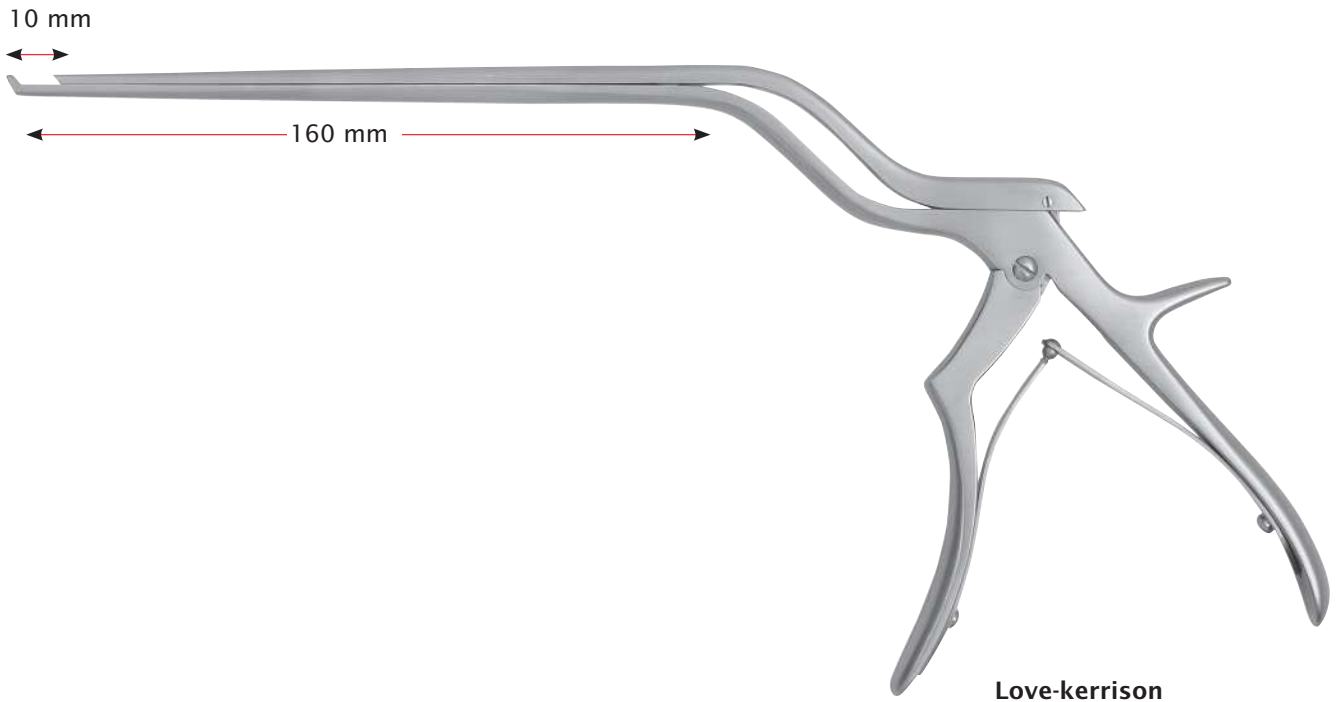

Standardfuß
Standard footplate
 Lámin de punzonar standard
 Battente standard

Schaftlänge Length of shaft Longitud del vástago Lunghezza dell`asta	Bissbreite / Width of bite / Anchura de la boca / Larghezza del morso			
	2 mm	3 mm	4 mm	5 mm
160 mm	NEU-630-002	NEU-630-003	NEU-630-004	NEU-630-005



Dünnfuß (Mikro)
Thin footplate (Micro)
 Lámina de punzonar estrecha (Micro)
 Battente sottile

Schaftlänge Length of shaft Longitud del vástago Lunghezza dell`asta	Bissbreite / Width of bite / Anchura de la boca / Larghezza del morso			
	2 mm	3 mm	4 mm	5 mm
160 mm	NEU-640-002	NEU-640-003	NEU-640-004	NEU-640-005



Kleiner Griff
Small handle
Mango pequeño
Manico piccolo

Kerrison



Schaftlänge Length of shaft Longitud del vástago Lunghezza dell'asta	Bissbreite / Width of bite / Anchura de la boca / Larghezza del morso				
	2 mm	3 mm	4 mm	5 mm	6 mm
180 mm	NEU-650-002	NEU-650-003	NEU-650-004	NEU-650-005	NEU-650-006
200 mm	NEU-652-002	NEU-652-003	NEU-652-004	NEU-652-005	NEU-652-006

Laminektomie-Stanzen
Laminectomy Punches
 Pinzas cortantes para laminectomia
 Pinze per laminectomia

nicht zerlegbar
non detachable
 non smontabile
 non desmontabile



Kerrison



10 mm

130° (40°)

Schaftlänge Length of shaft Longitud del vástago Lunghezza dell'asta	Bissbreite / Width of bite / Anchura de la boca / Larghezza del morso			
	2 mm	3 mm	4 mm	5 mm
180 mm	NEU-670-002	NEU-670-003	NEU-670-004	NEU-670-005

- ein teil
- einfach zu demontieren
- einfach zu reinigen
- einfach zusammenzufügen

Demontage Disassembly



Zuerst den Griff schließen ...
First close the handle ...



dann den Riegel nach unten drücken ...
than push the lever downwards ...

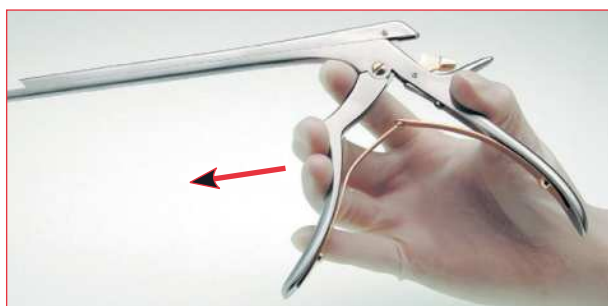

nun den Griff wieder öffnen ...
now open the handle ...



und hinten auf den Schaft drücken.
and push downwards at the end of shaft.

- one piece
- easy to disassemble
- **easy to clean**
- easy to assemble

Zusammenfügen Assembly



Zuerst Schaftteile ineinandersetzen ...
First push shaft parts into one other ...

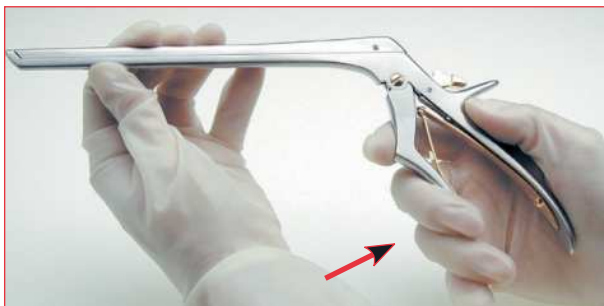

dann den Griff schließen ...
than close the handle ...



nun den Riegel nach oben drücken ...
now push the lever upwards ...

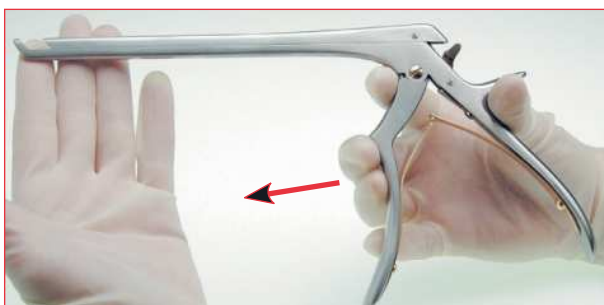

und den Griff wieder öffnen.
and finally open the handle.

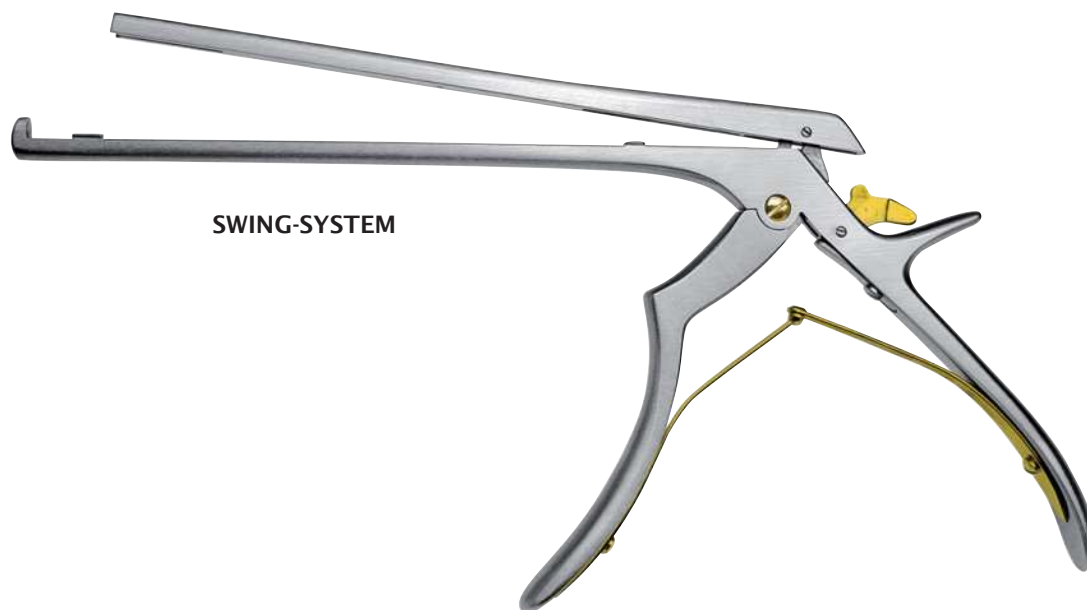

SWING-SYSTEM

Kerrison

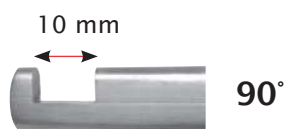

Schaftlänge Length of shaft Longitud del vástago Lunghezza dell`asta	Bissbreite / Width of bite / Anchura de la boca / Larghezza del morso					
	1 mm	2 mm	3 mm	4 mm	5 mm	6 mm
180 mm	NEU-700-001	NEU-700-002	NEU-700-003	NEU-700-004	NEU-700-005	NEU-700-006
200 mm	NEU-702-001	NEU-702-002	NEU-702-003	NEU-702-004	NEU-702-005	NEU-702-006
230 mm	NEU-704-001	NEU-704-002	NEU-704-003	NEU-704-004	NEU-704-005	NEU-704-006

Laminektomie-Stanzen

Laminectomy Punches

Pinzas cortantes para laminectomia

Pinze per laminectomia

zerlegbar

detachable

desmontable

smontabile

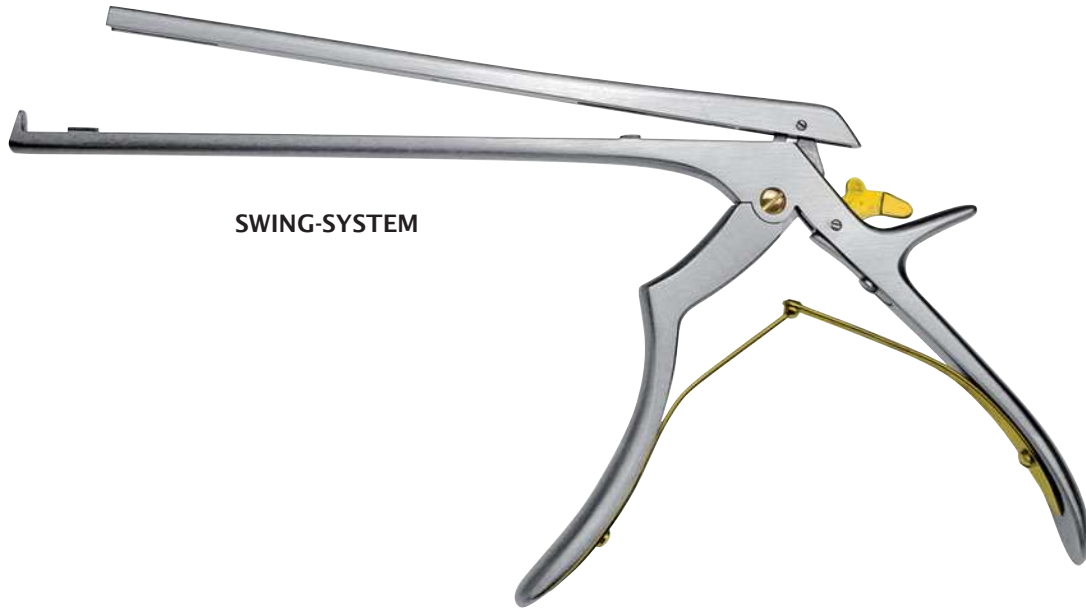

SWING-SYSTEM

Kerrison

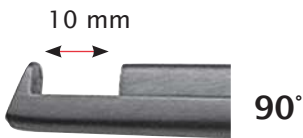

10 mm

90°

Dünnfuß (Mikro)

Thin footplate (Micro)

Lámina de punzonar estrecha (Micro)

Battente sottile

Schaftlänge Length of shaft Longitud del vástago Lunghezza dell' asta	Bissbreite / Width of bite / Anchura de la boca / Larghezza del morso				
	2 mm	3 mm	4 mm	5 mm	6 mm
180 mm	NEU-710-002	NEU-710-003	NEU-710-004	NEU-710-005	NEU-710-006
200 mm	NEU-712-002	NEU-712-003	NEU-712-004	NEU-712-005	NEU-712-006
230 mm	NEU-714-002	NEU-714-003	NEU-714-004	NEU-714-005	NEU-714-006

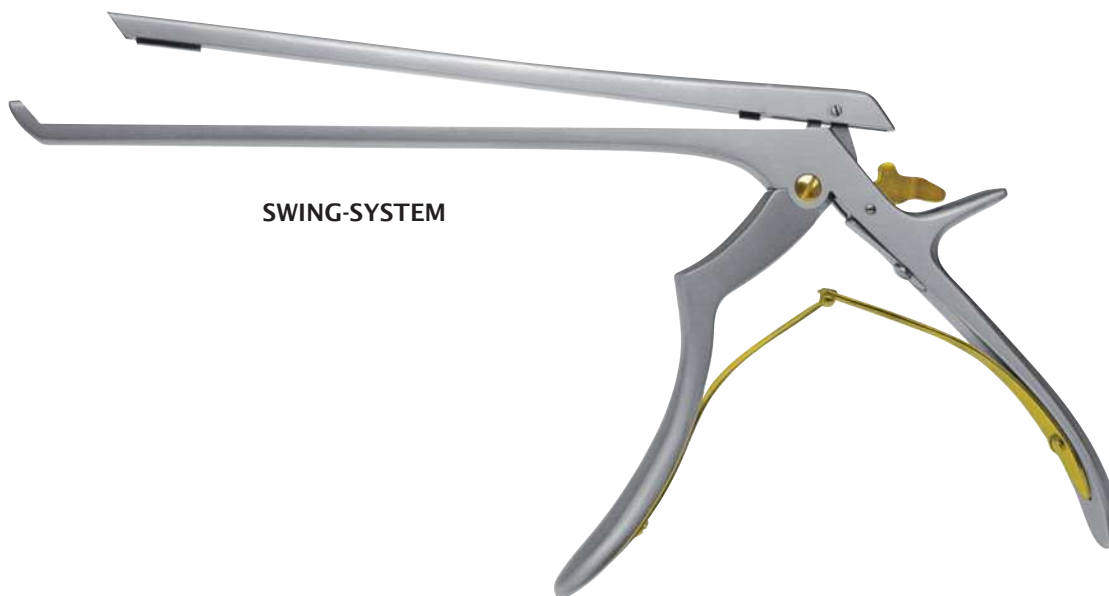

SWING-SYSTEM

Kerrison

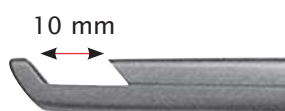

130° (40°)

Schaftlänge Length of shaft Longitud del vástago Lunghezza dell`asta	Bissbreite / Width of bite / Anchura de la boca / Larghezza del morso					
	1 mm	2 mm	3 mm	4 mm	5 mm	6 mm
180 mm	NEU-720-001	NEU-720-002	NEU-720-003	NEU-720-004	NEU-720-005	NEU-720-006
200 mm	NEU-722-001	NEU-722-002	NEU-722-003	NEU-722-004	NEU-722-005	NEU-722-006
230 mm	NEU-724-001	NEU-724-002	NEU-724-003	NEU-724-004	NEU-724-005	NEU-724-006

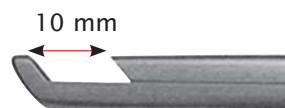

130° (40°)

mit Auswerfer
with ejector
con espulsor
con espulsore

Schaftlänge Length of shaft Longitud del vástago Lunghezza dell`asta	Bissbreite / Width of bite / Anchura de la boca / Larghezza del morso			
	3 mm	4 mm	5 mm	6 mm
180 mm	NEU-730-003	NEU-730-004	NEU-730-005	NEU-730-006
200 mm	NEU-732-003	NEU-732-004	NEU-732-005	NEU-732-006
230 mm	NEU-734-003	NEU-734-004	NEU-734-005	NEU-734-006

Laminektomie-Stanzen

Laminectomy Punches

Pinzas cortantes para laminectomia

Pinze er laminectomia

zerlegbar

detachable

desmontable

smontabile

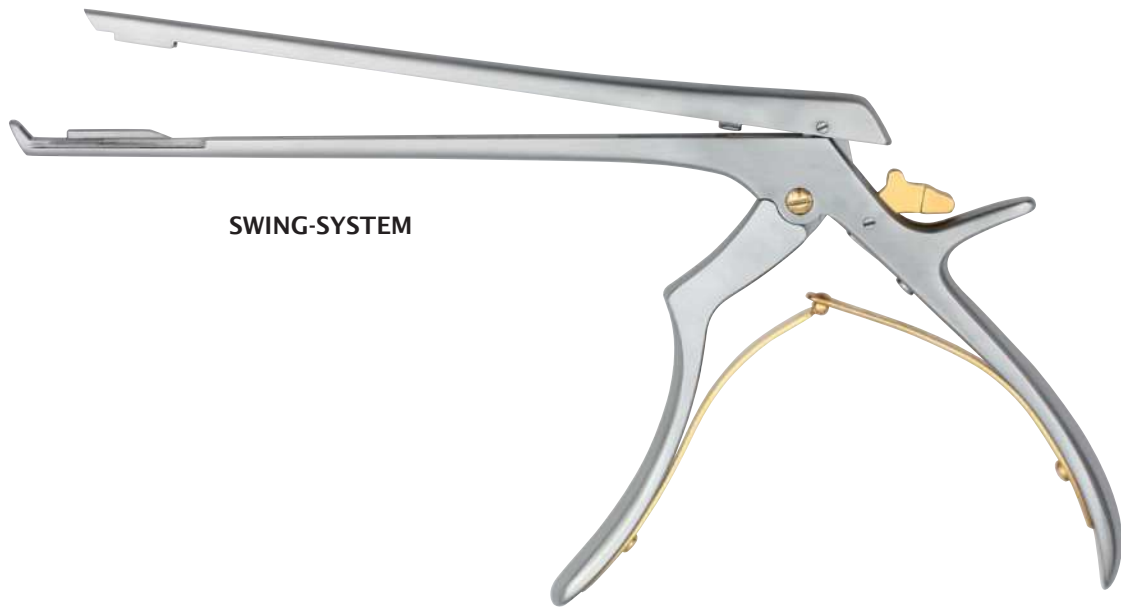

SWING-SYSTEM

Kerrison

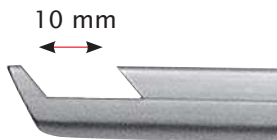

130° (40°)

Dünnfuß (Mikro)

Thin footplate (Micro)

Lámina de punzonar estrecha (Micro)

Battente sottile

Schaftlänge Length of shaft Longitud del vástago Lunghezza dell`asta	Bissbreite / Width of bite / Anchura de la boca / Larghezza del morso					
	1 mm	2 mm	3 mm	4 mm	5 mm	6 mm
180 mm	NEU-740-001	NEU-740-002	NEU-740-003	NEU-740-004	NEU-740-005	NEU-740-006
200 mm	NEU-742-001	NEU-742-002	NEU-742-003	NEU-742-004	NEU-742-005	NEU-742-006
230 mm	NEU-744-001	NEU-744-002	NEU-744-003	NEU-744-004	NEU-744-005	NEU-744-006

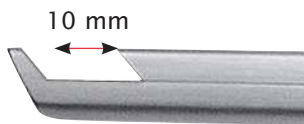

130° (40°)

Dünnfuß (Mikro)

Thin footplate (Micro)

Lámina de punzonar estrecha (Micro)

Battente sottile

mit Auswerfer

with ejector

con espulsore

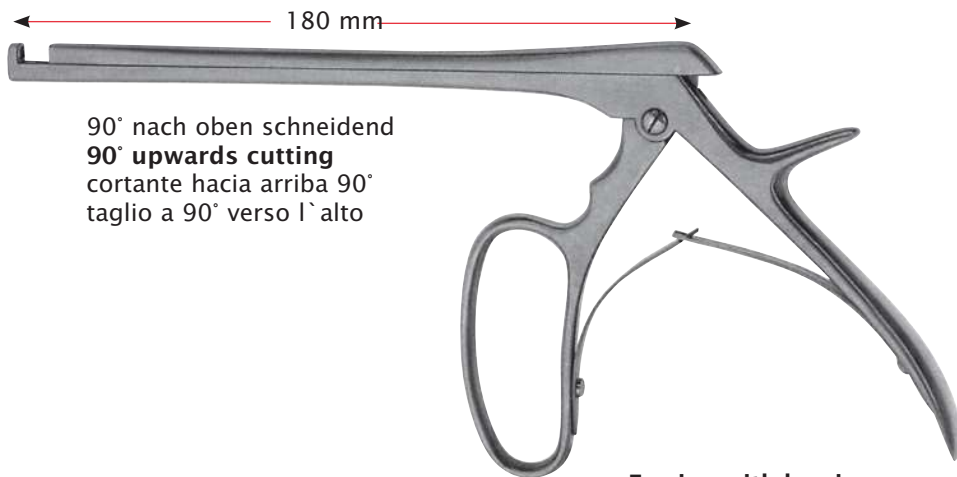

con espulsore

Schaftlänge Length of shaft Longitud del vástago Lunghezza dell`asta	Bissbreite / Width of bite / Anchura de la boca / Larghezza del morso			
	3 mm	4 mm	5 mm	6 mm
180 mm	NEU-750-003	NEU-750-004	NEU-750-005	NEU-750-006
200 mm	NEU-752-003	NEU-752-004	NEU-752-005	NEU-752-006
230 mm	NEU-754-003	NEU-754-004	NEU-754-005	NEU-754-006



90° nach oben schneidend
90° upwards cutting
cortante hacia arriba 90°
taglio a 90° verso l'alto

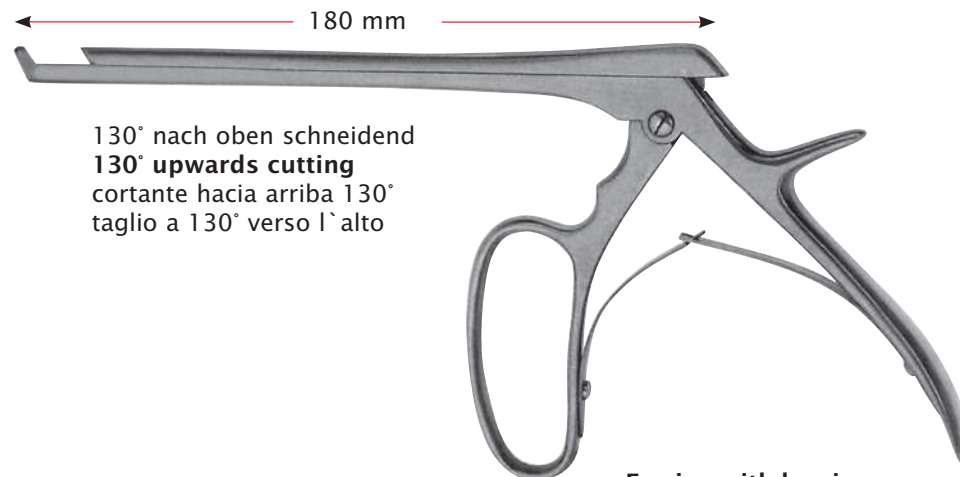

Ferris-smith-kerrison

NEU-790-003 3,0 mm 
NEU-790-005 5,0 mm 



130° nach oben schneidend
130° upwards cutting
cortante hacia arriba 130°
taglio a 130° verso l'alto

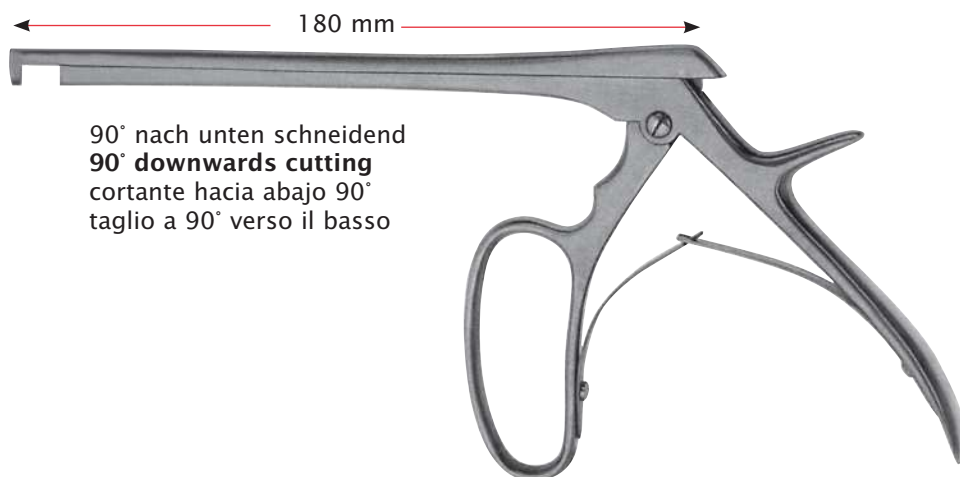

Ferris-smith-kerrison

a = 180 mm a = 200 mm
NEU-792-003 NEU-794-003 3,0 mm 
NEU-792-005 NEU-794-005 5,0 mm 



90° nach unten schneidend
90° downwards cutting
cortante hacia abajo 90°
taglio a 90° verso il basso

Ferris-smith-kerrison

NEU-796-003 3,0 mm 
NEU-796-005 5,0 mm 

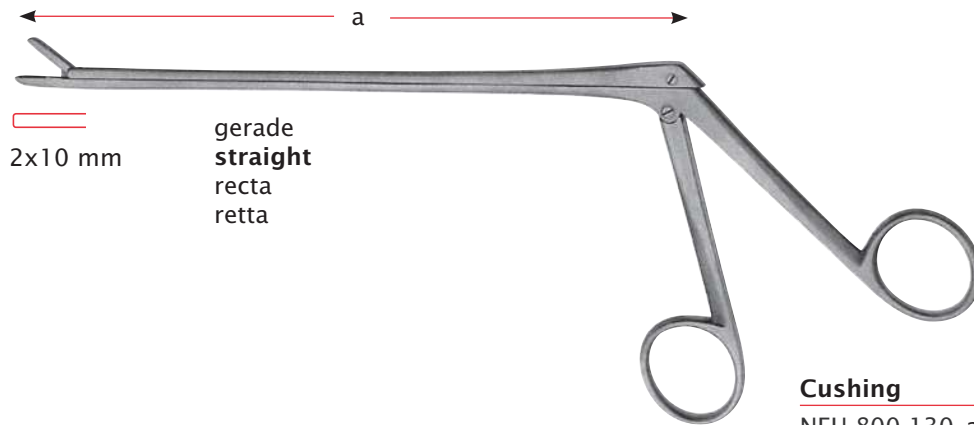

Cushing

NEU-800-130 a = 130 mm
NEU-800-150 a = 150 mm
NEU-800-180 a = 180 mm

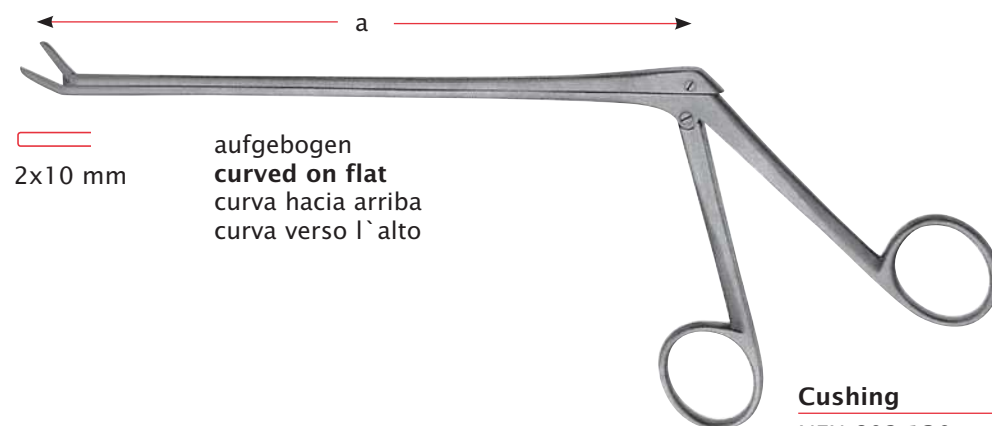

Cushing

NEU-802-130 a = 130 mm
NEU-802-150 a = 150 mm
NEU-802-180 a = 180 mm

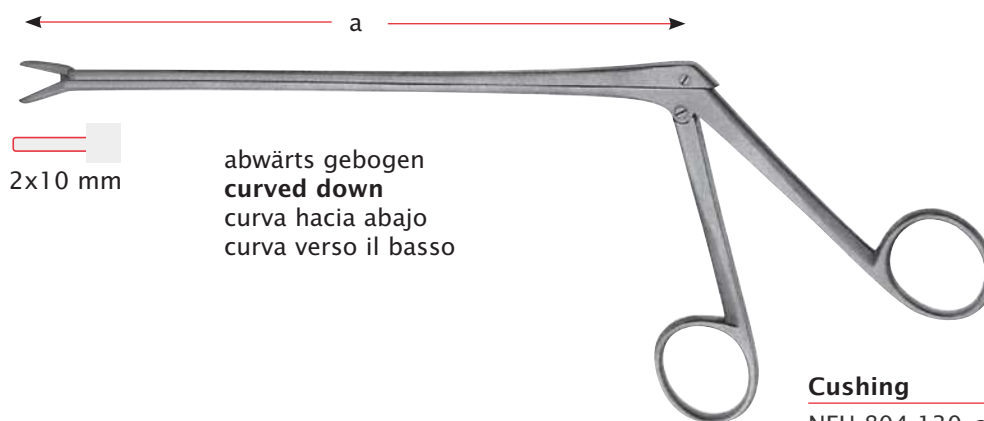

Cushing

NEU-804-130 a = 130 mm
NEU-804-150 a = 150 mm
NEU-804-180 a = 180 mm

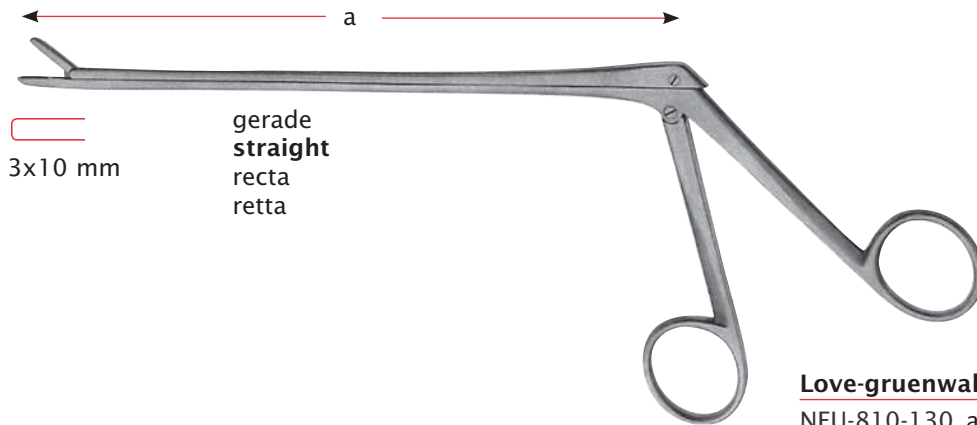

3x10 mm
gerade
straight
recta
retta

Love-gruenwald

NEU-810-130 a = 130 mm
NEU-810-150 a = 150 mm
NEU-810-180 a = 180 mm

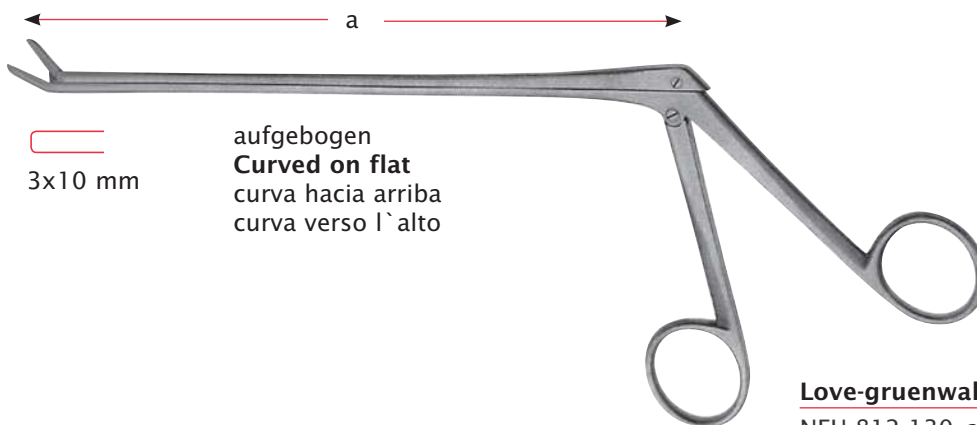

3x10 mm
aufgebogen
Curved on flat
curva hacia arriba
curva verso l'alto

Love-gruenwald

NEU-812-130 a = 130 mm
NEU-812-150 a = 150 mm
NEU-812-180 a = 180 mm

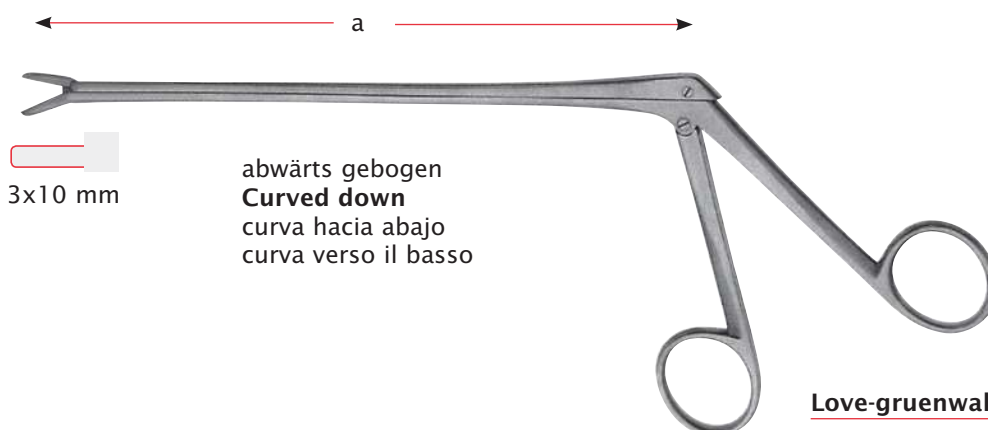

3x10 mm
abwärts gebogen
Curved down
curva hacia abajo
curva verso il basso

Love-gruenwald

NEU-814-130 a = 130 mm
NEU-814-150 a = 150 mm
NEU-814-180 a = 180 mm

Laminectomie-zangen
Laminectomy rongeurs
Pinzas cortantes para laminectomía
Pinze per laminectomia

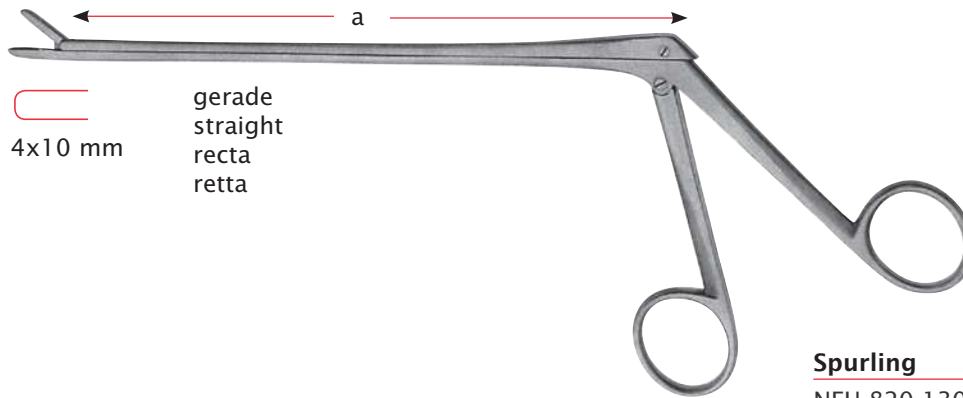

gerade
straight
recta
retta

Spurling

NEU-820-130 a = 130 mm
NEU-820-150 a = 150 mm
NEU-820-180 a = 180 mm

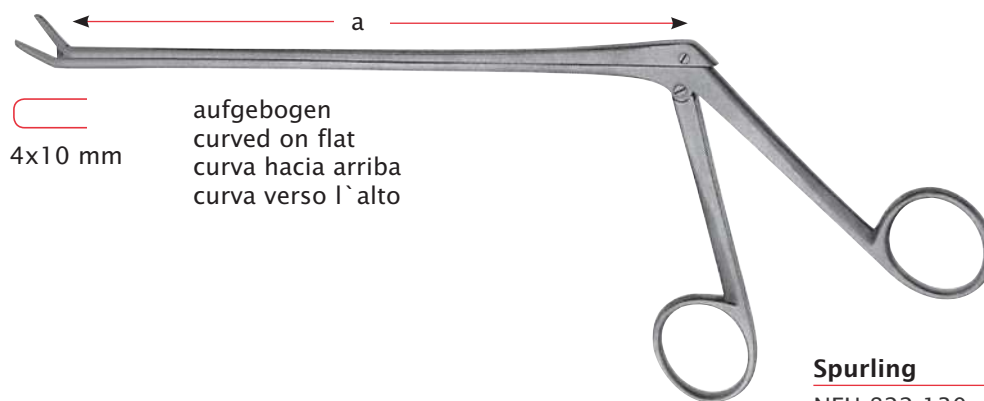

aufgebogen
curved on flat
curva hacia arriba
curva verso l'alto

Spurling

NEU-822-130 a = 130 mm
NEU-822-150 a = 150 mm
NEU-822-180 a = 180 mm

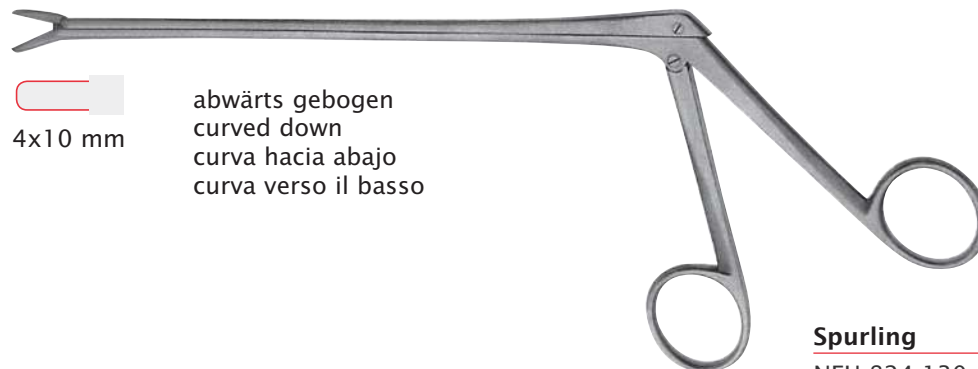

abwärts gebogen
curved down
curva hacia abajo
curva verso il basso

Spurling

NEU-824-130 a = 130 mm
NEU-824-150 a = 150 mm
NEU-824-180 a = 180 mm

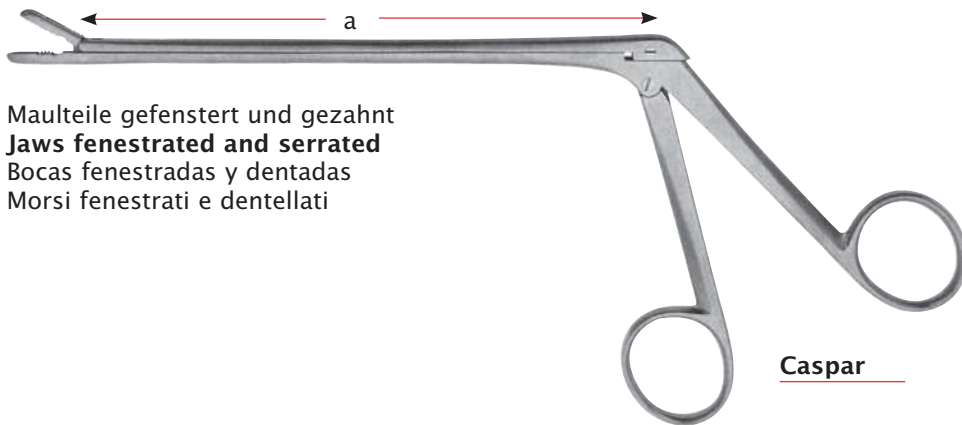

Maulteile gefenstert und gezahnt
Jaws fenestrated and serrated
Bocas fenestradas y dentadas
Morsi fenestrati e dentellati

Caspar

Schaftlänge Length of shaft Longitud del vástago Lunghezza dell' asta	Bissbreite / Width of bite / Anchura de la boca / Larghezza del morso				
	2,0 x 12,0 mm	3,0 x 12,0 mm	4,0 x 14,0 mm	5,0 x 14,0 mm	6,0 x 16,0 mm
a = 140 mm	NEU-830-140	NEU-832-140	NEU-834-140	NEU-836-140	NEU-838-140
a = 160 mm	NEU-830-160	NEU-832-160	NEU-834-160	NEU-836-160	NEU-838-160
a = 185 mm	NEU-830-185	NEU-832-185	NEU-834-185	NEU-836-185	NEU-838-185

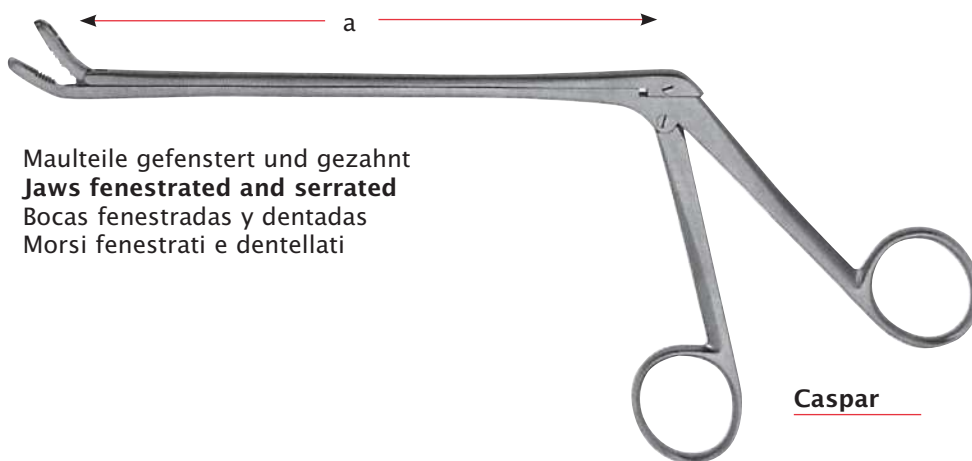

Maulteile gefenstert und gezahnt
Jaws fenestrated and serrated
Bocas fenestradas y dentadas
Morsi fenestrati e dentellati

Caspar

Schaftlänge Length of shaft Longitud del vástago Lunghezza dell' asta	Bissbreite / Width of bite / Anchura de la boca / Larghezza del morso		
	3,0 x 12,0 mm	4,0 x 14,0 mm	5,0 x 14,0 mm
a = 140 mm	NEU-842-140	NEU-844-140	NEU-846-140
a = 160 mm	NEU-842-160	NEU-844-160	NEU-846-160
a = 185 mm	NEU-842-185	NEU-844-185	NEU-846-185

Laminectomie-zangen
Laminectomy rongeurs
 Pinzas cortantes para laminectomia
 Pinze per laminectomia

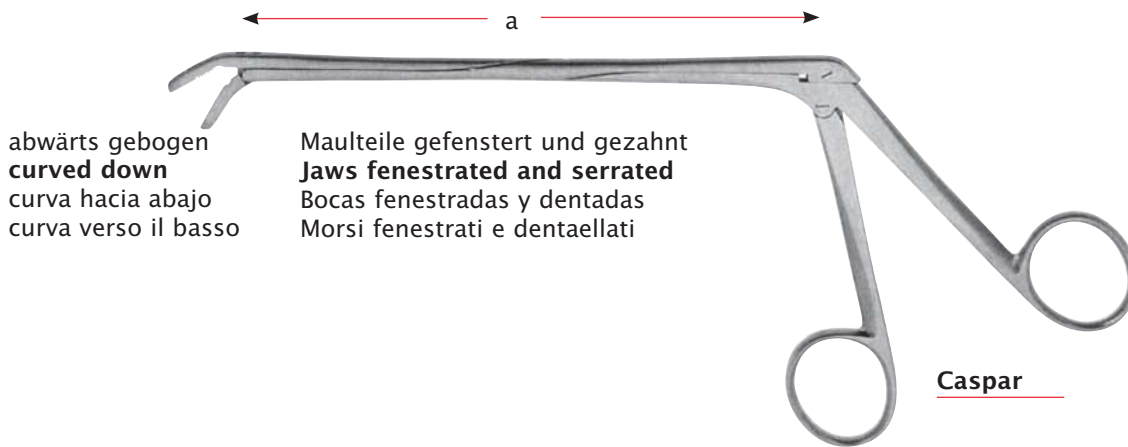

Schaftlänge Length of shaft Longitud del vástago Lunghezza dell'asta	Bissbreite / Width of bite / Anchura de la boca / Larghezza del morso	
	3,0 x 12,0 mm	4,0 x 14,0 mm
a = 140 mm	NEU-852-140	NEU-854-140
a = 160 mm	NEU-852-160	NEU-854-160
a = 185 mm	NEU-852-185	NEU-854-185

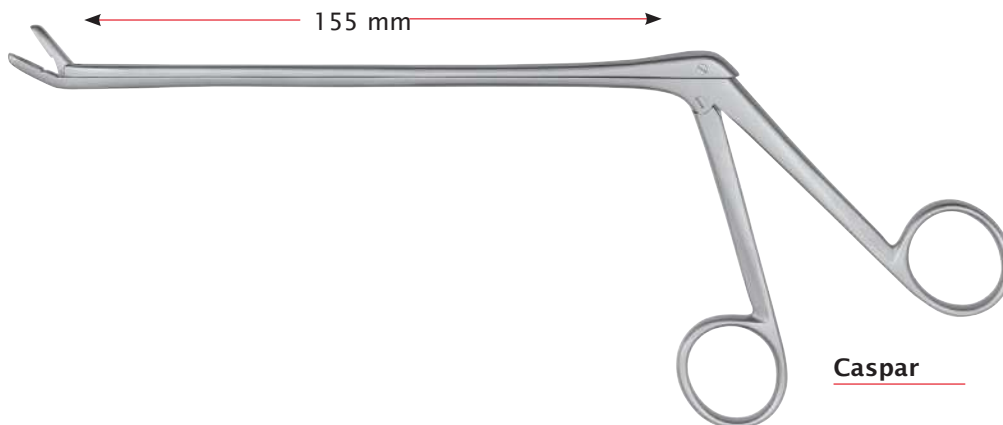

	Bissbreite / Width of bite / Anchura de la boca / Larghezza del morso			
	NEU-860-002	NEU-860-003	NEU-860-004	NEU-860-005
	NEU-862-002	NEU-862-003	NEU-862-004	NEU-862-005
	NEU-864-002	NEU-864-003	NEU-864-004	NEU-864-005



Yasargil
NEU-870-180 Ø 2,0 mm





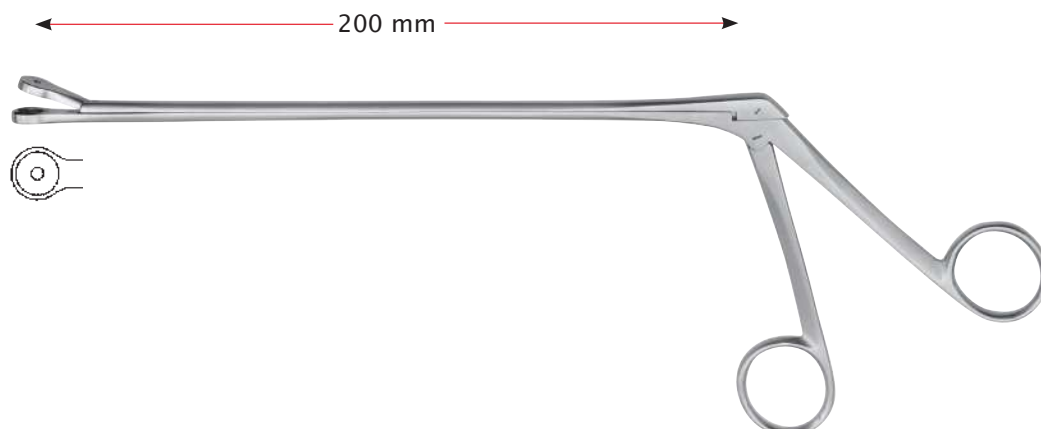



Oldberg
NEU-872-180 Ø 3,5 mm

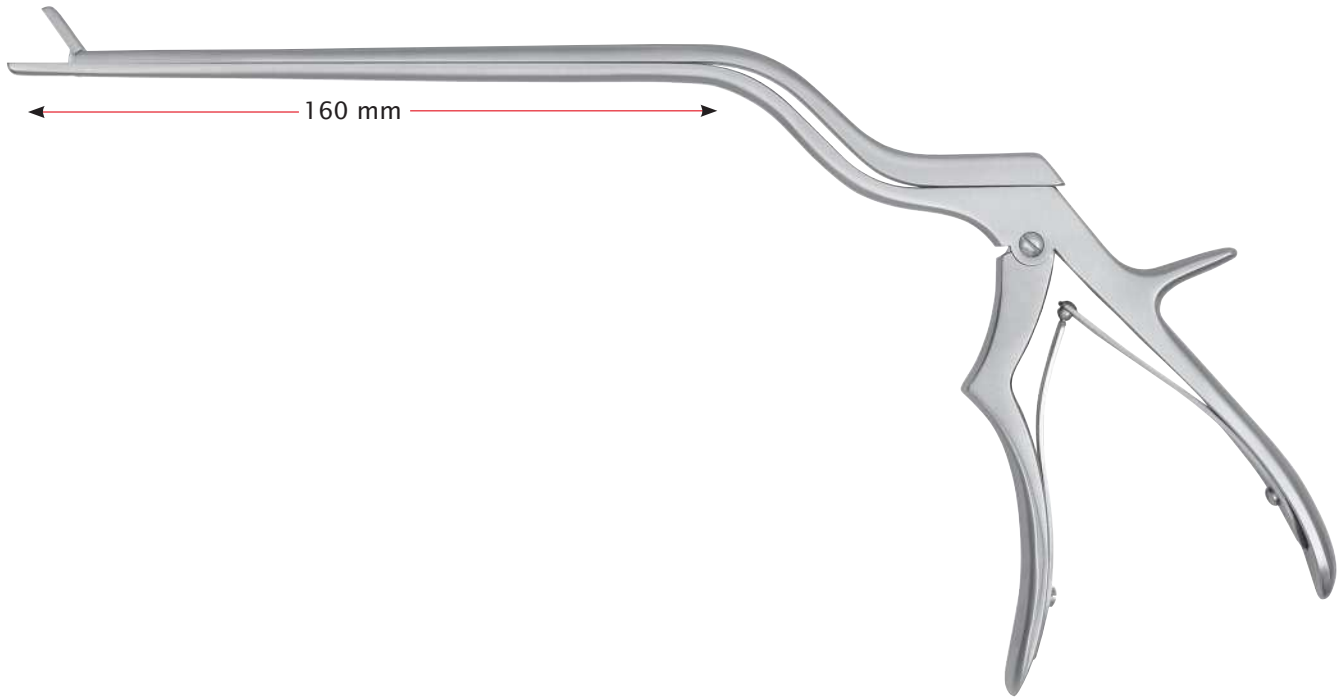

Landolt
NEU-874-200 Ø 9,0 mm

Laminectomie-zangen
Laminectomy rongeurs
 Pinzas cortantes para laminectomía
 Pinze per laminectomia



	Bissbreite / Width of bite / Anchura de la boca / Larghezza del morso		
			
	2,0 x 8,0 mm	3,0 x 9,0mm	4,0 x 10,0 mm
	NEU-880-002	NEU-880-003	NEU-880-004
	NEU-882-002	NEU-882-003	NEU-882-004

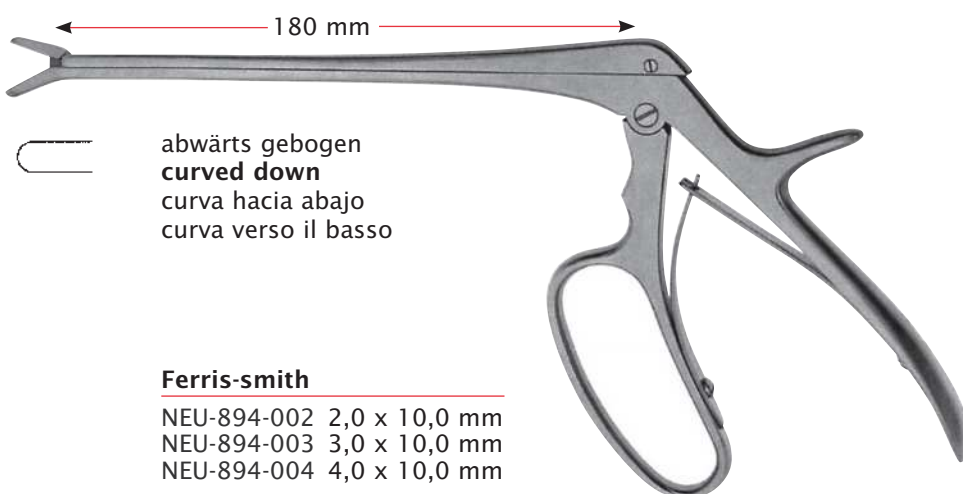
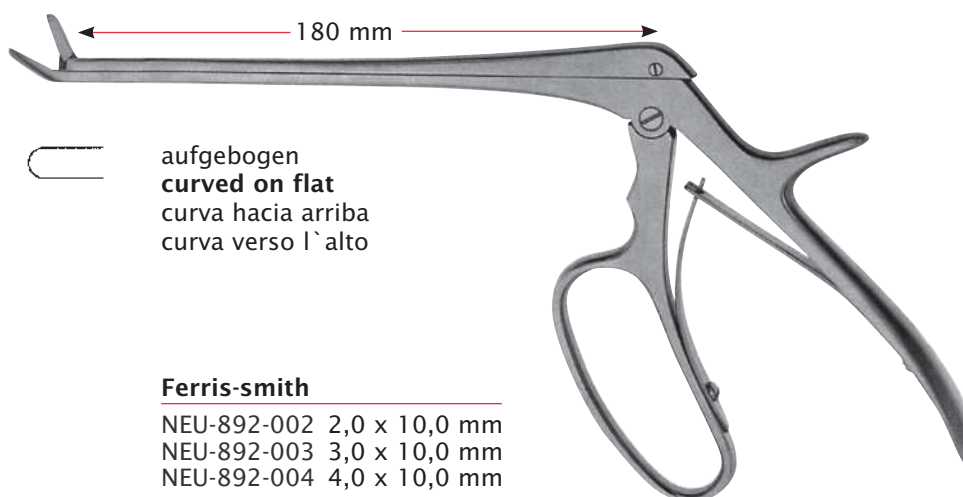
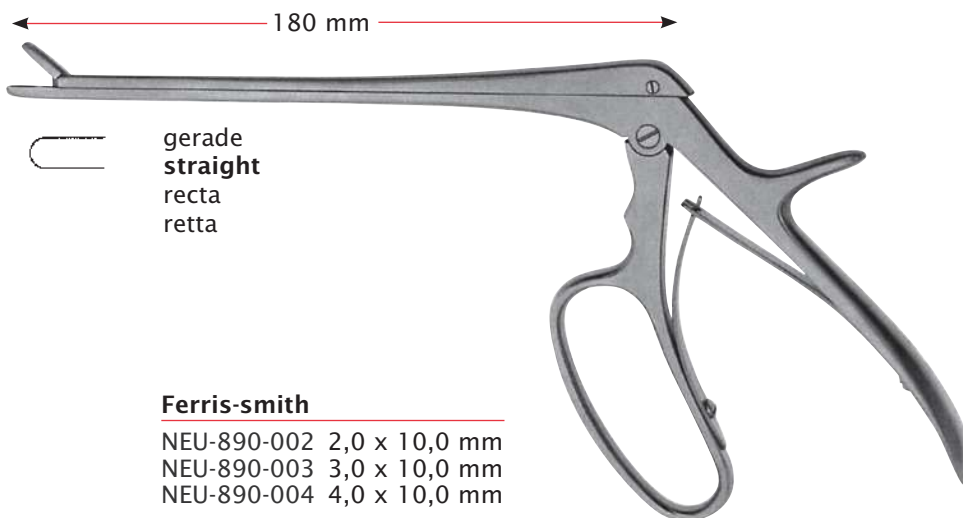

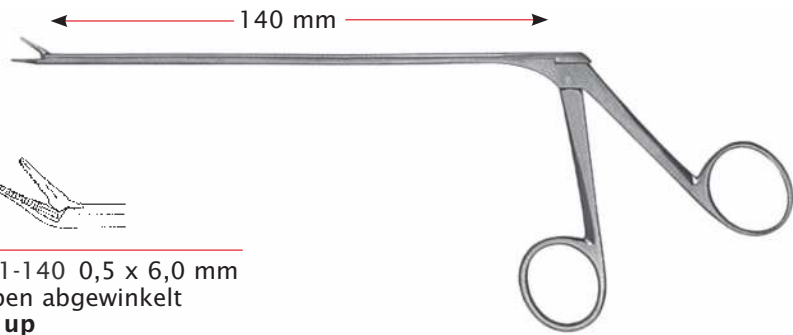

NEU-900-140 0,5 x 6,0 mm
 gerade
straight
 recta



NEU-901-140 0,5 x 6,0 mm
 nach oben abgewinkelt
angled up
 angulada hacia arriba
 angolata in alto



NEU-903-140 0,5 x 6,0 mm
 nach rechts gebogen
curved to right
 curva a la derecha
 curve a destra



NEU-905-140 0,5 x 6,0 mm
 nach links gebogen
curved to left
 curva a la izquierda
 curve a sinistra

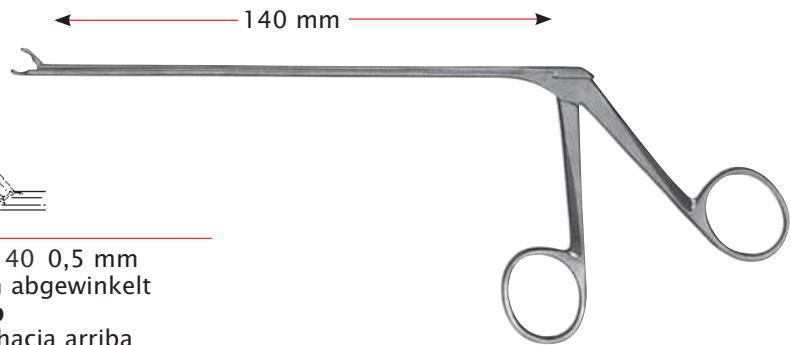

NEU-910-140 0,5 mm
 NEU-920-140 1,0 mm
 gerade
straight
 recta



NEU-911-140 0,5 mm
 nach oben abgewinkelt
angled up
 angulada hacia arriba
 angolata in alto





NEU-913-140 0,5 mm
 NEU-923-140 1,0 mm
 nach rechts gebogen
curved to right
 curva a la derecha
 curve a destra



NEU-915-140 0,5 mm
 NEU-925-140 1,0 mm
 nach links gebogen
curved to left
 curva a la izquierda
 curve a sinistra



NEU-930-140 Ø 2,0 mm 
NEU-932-140 Ø 3,0 mm 

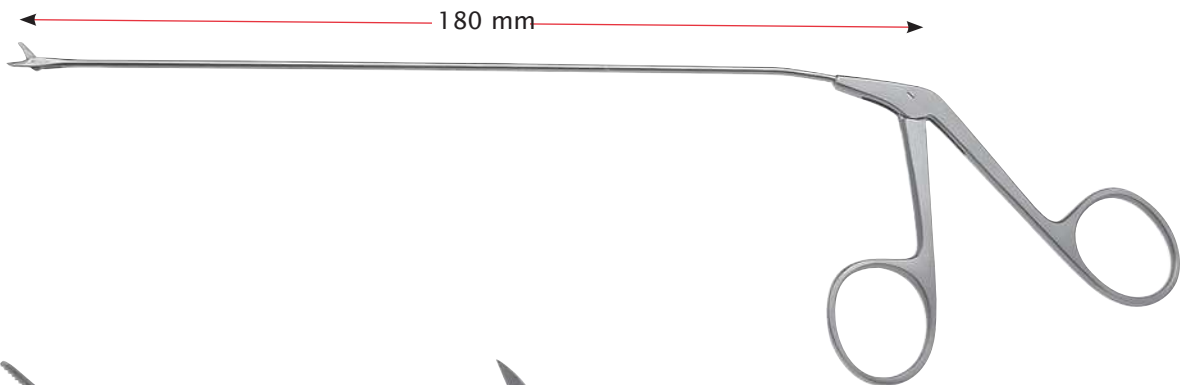

Yasargil
NEU-940-180 Ø 2,0 mm



Nicola
NEU-942-180 Ø 2,0 mm



Nicola
NEU-944-180 Ø 2,0 mm



instrument
Superior Quality, Trusted Precision

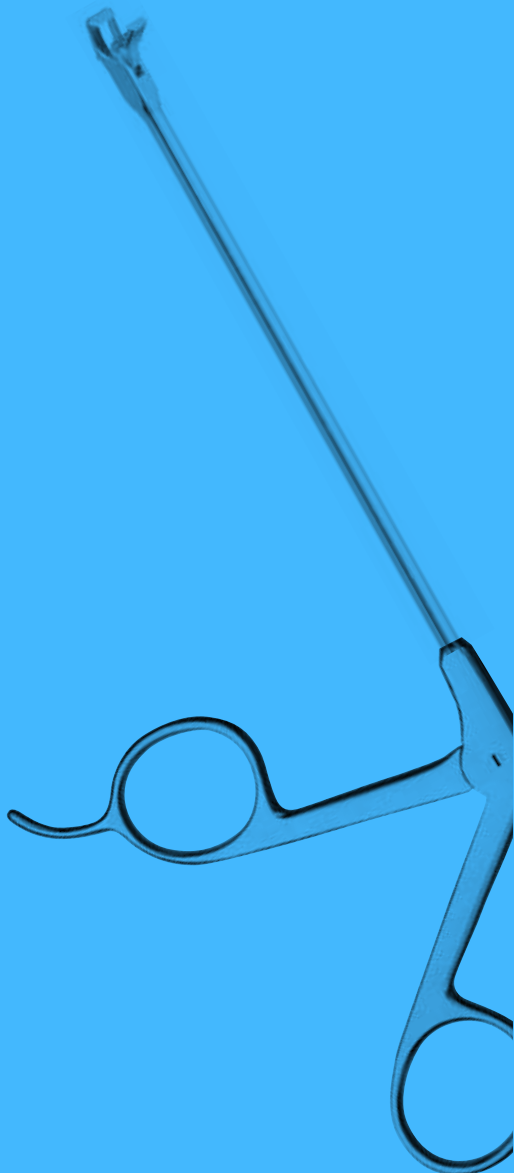

Arthroskopie

Arthroscopy

Artroscopia

Artroscopia

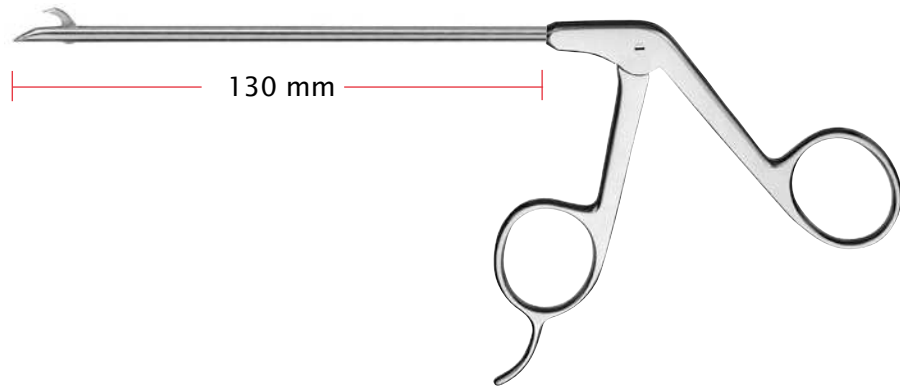

Hakenstanze mit Schippe
Hook punch, scoope nose
Pinza cortante, de nariz aguda

3,4 mm Ø
cutting size 5 x 1,6

2,8 mm Ø
cutting size 4 x 1,2

gerade / straight / recta

SP40-034130-000

SP40-028130-000



30°

Schaft gebogen / shaft curved
vaina curva:

rechts / right / derecha

SP40-034130-030

SP40-028130-030

links / left / izquierda

SP40-034130-130

SP40-028130-130



45°

rechts / right / derecha

SP40-034130-045

SP40-028130-045

links / left / izquierda

SP40-034130-145

SP40-028130-145



7°

aufwärts / upwards
hacia arriba

SP40-034130-007

SP40-028130-007

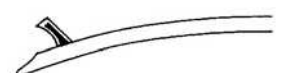

abwärts / downwards
hacia abajo

SP40-034130-107

SP40-028130-107



15°

aufwärts / upwards
hacia arriba

SP40-034130-015

SP40-028130-015



abwärts / downwards
hacia abajo

SP40-034130-115

SP40-028130-115

Hakenstanze, mit Schippe 15°
Hook punch, scoope nose 15°
 Pinza cortante, de nariz aguda 15°

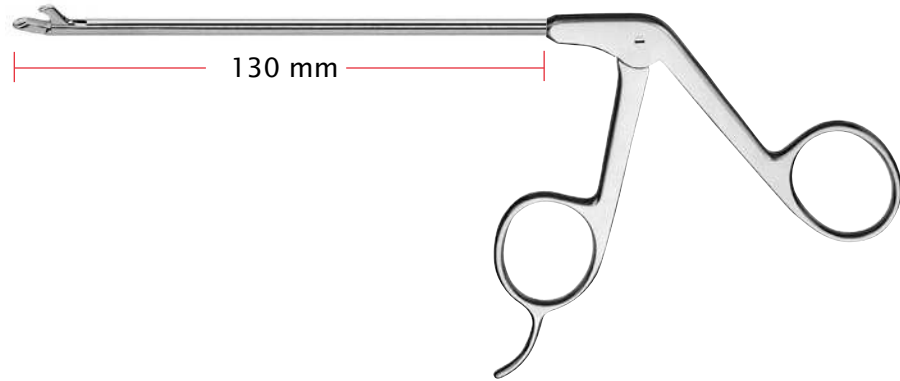

3,4 mm Ø cutting size 5 x 1,6	2,8 mm Ø cutting size 4 x 1,2
----------------------------------	----------------------------------



Hakenstanze mit Schippe
 Hook punch, scoope nose
 Pinza cortante, de nariz aguda

gerade / straight / recta

SP40-034130-200

SP40-028130-200



30°

Schaft gebogen / shaft curved
 vaina curva:

rechts / right / derecha

SP40-034130-230

SP40-028130-230

links / left / izquierda

SP40-034130-330

SP40-028130-330



45°

rechts / right / derecha

SP40-034130-245

SP40-028130-245

links / left / izquierda

SP40-034130-345

SP40-028130-345



7°

aufwärts / upwards
 hacia arriba

SP40-034130-207

SP40-028130-207



abwärts / downwards
 hacia abajo

SP40-034130-307

SP40-028130-307



15°

aufwärts / upwards
 hacia arriba

SP40-034130-215

SP40-028130-215



abwärts / downwards
 hacia abajo

SP40-034130-315

SP40-028130-315

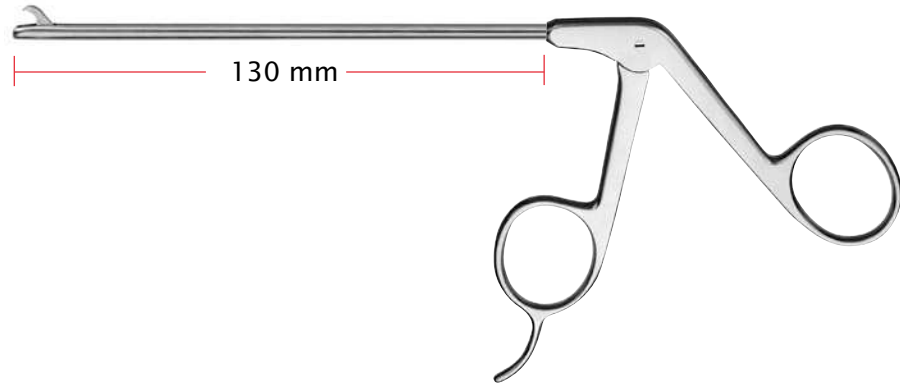

3,4 mm Ø cutting size 5 x 1,6	2,8 mm Ø cutting size 4 x 1,2
----------------------------------	----------------------------------



Hakenstanze, stumpf
Hook punch, blunt nose
Pinza cortante, de nariz roma

gerade / straight / recta

SP41-034130-000

SP41-028130-000



30°

Schaft gebogen / shaft curved
vaina curva:

rechts / right / derecha

SP41-034130-030

SP41-028130-030

links / left / izquierda

SP41-034130-130

SP41-028130-130



45°

rechts / right / derecha

SP41-034130-045

SP41-028130-045

links / left / izquierda

SP41-034130-145

SP41-028130-145



7°

aufwärts / upwards
hacia arriba

SP41-034130-007

SP41-028130-007

abwärts / downwards
hacia abajo

SP41-034130-107

SP41-028130-107



15°

aufwärts / upwards
hacia arriba

SP41-034130-015

SP41-028130-015

abwärts / downwards
hacia abajo

SP41-034130-115

SP41-028130-115

Hakenstanze, stumpf 15°
Hook punch, blunt nose 15°
 Pinza cortante, de nariz roma 15°

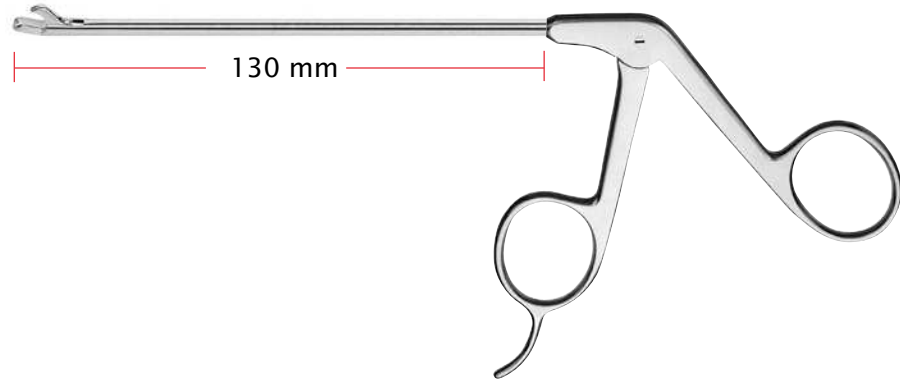

3,4 mm Ø cutting size 5 x 1,6	2,8 mm Ø cutting size 4 x 1,2
----------------------------------	----------------------------------



Hakenstanze, stumpf
 Hook punch, blunt nose
 Pinza cortante, de nariz roma

gerade / straight / recta

SP41-034130-400

SP41-028130-400



30°

Schaft gebogen / shaft curved
 vaina curva:

rechts / right / derecha

SP41-034130-430

SP41-028130-430

links / left / izquierda

SP41-034130-630

SP41-028130-630



45°

rechts / right / derecha

SP41-034130-445

SP41-028130-445

links / left / izquierda

SP41-034130-645

SP41-028130-645



7°

aufwärts / upwards
 hacia arriba

SP41-034130-407

SP41-028130-407

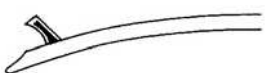

abwärts / downwards
 hacia abajo

SP41-034130-607

SP41-028130-607



15°

aufwärts / upwards
 hacia arriba

SP41-034130-415

SP41-028130-415



abwärts / downwards
 hacia abajo

SP41-034130-615

SP41-028130-615

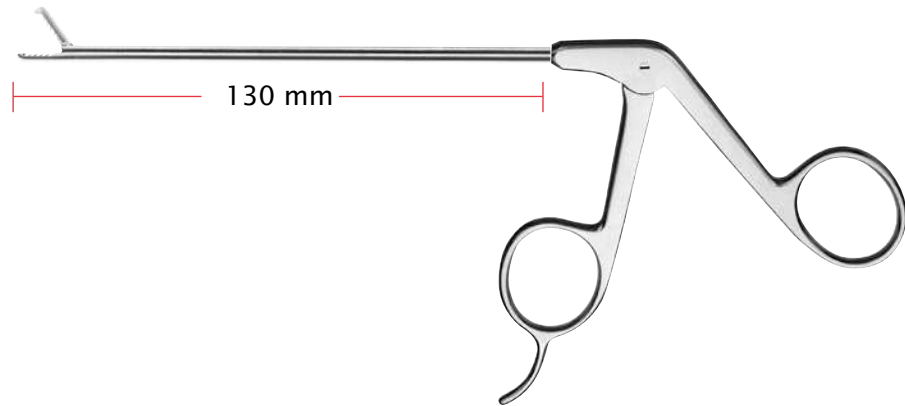

Stanze, gezahnt
Punch, serrated
Pinza cortante aserrada

gerade / straight / recta

3,4 mm Ø
cutting size 6 x 2

2,8 mm Ø
cutting size 5 x 1,6

SP42-034130-000

SP42-028130-000



30°

Schaft gebogen / shaft curved
vaina curva:

rechts / right / derecha

SP42-034130-030

SP42-028130-030

links / left / izquierda

SP42-034130-130

SP42-028130-130



45°

rechts / right / derecha

SP42-034130-045

SP42-028130-045

links / left / izquierda

SP42-034130-145

SP42-028130-145



7°

aufwärts / upwards
hacia arriba

SP42-034130-007

SP42-028130-007



abwärts / downwards
hacia abajo

SP42-034130-107

SP42-028130-107



15°

aufwärts / upwards
hacia arriba

SP42-034130-015

SP42-028130-015











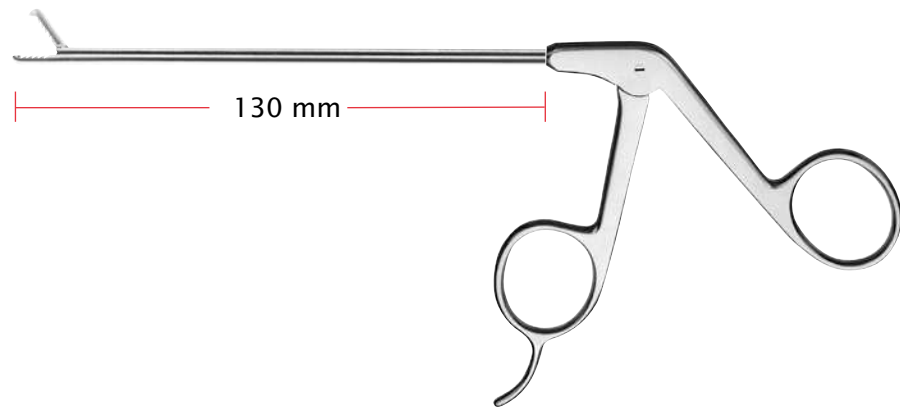

abwärts / downwards
hacia abajo

SP42-034130-115

SP42-028130-115

Stanze, gezahnt „Duck“ Form
Punch, serrated, „Duck“ shaped
 Pinza cortante, aserrada, pico de pato



		3,4 mm Ø cutting size 6 x 2	2,8 mm Ø cutting size 5 x 1,6
	Stanze, gezahnt „Duck“ Form 15° Punch, serrated, „Duck“ shaped 15° Pinza cortante, aserrada, pico de pato 15°		
	gerade / straight / recta	SP41-034130-200	SP41-028130-200
	Schaft gebogen / shaft curved vaina curva:		
	rechts / right / derecha	SP41-034130-230	SP41-028130-230
	links / left / izquierda	SP41-034130-330	SP41-028130-330
	rechts / right / derecha	SP41-034130-245	SP41-028130-245
	links / left / izquierda	SP41-034130-345	SP41-028130-345
	aufwärts / upwards hacia arriba	SP41-034130-207	SP41-028130-207
	abwärts / downwards hacia abajo	SP41-034130-307	SP41-028130-307
	aufwärts / upwards hacia arriba	SP41-034130-215	SP41-028130-215
	abwärts / downwards hacia abajo	SP41-034130-315	SP41-028130-315

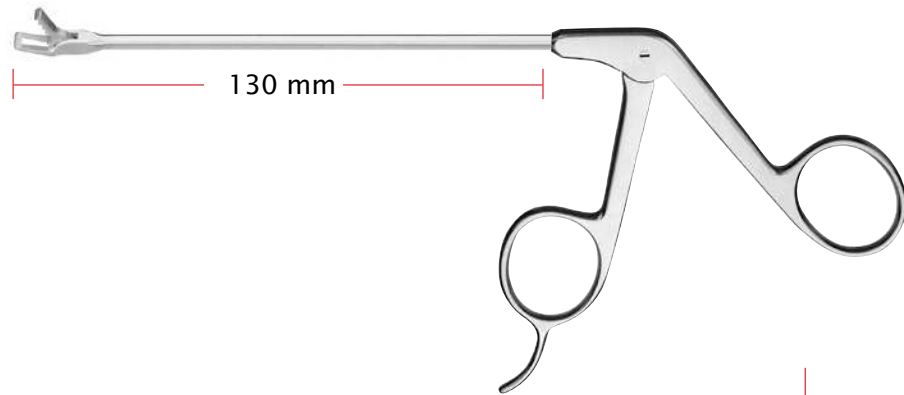

Standard



Duck

gerade / straight / recta

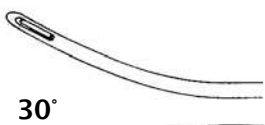

30°

Schaft gebogen / shaft curved
vaina curva:

rechts / right / derecha

links / left / izquierda



45°

rechts / right / derecha

links / left / izquierda

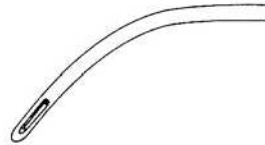

7°

aufwärts / upwards
hacia arriba

abwärts / downwards
hacia abajo

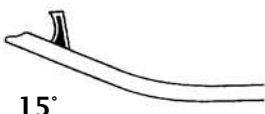
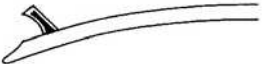

15°

aufwärts / upwards
hacia arriba

abwärts / downwards
hacia abajo



Standard

Duck“ Form, 15°
Duck“ shaped, 15°
pico de pato, 15°

3,4 mm Ø
cutting size 6 x 3,5

SP44-034130-000

3,4 mm Ø
cutting size 6 x 3,5

SP44-034130-200

SP44-034130-030

SP44-034130-230

SP44-034130-130

SP44-034130-330

SP44-034130-045

SP44-034130-245

SP44-034130-145

SP44-034130-345

SP44-034130-007

SP44-034130-207

SP44-034130-107

SP44-034130-307

SP44-034130-015

SP44-034130-215

SP44-034130-115

SP44-034130-315

Stanze, gezahnt, breit
Punch, serrated, wide
 Pinza cortante, aserrada, ancha

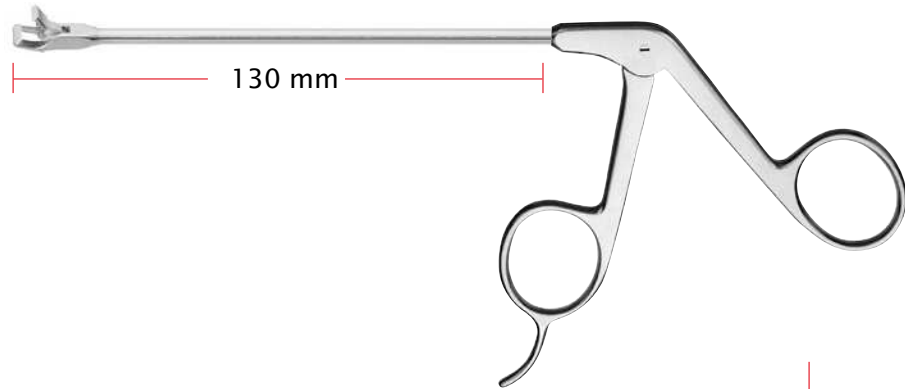

Standard



Duck

gerade / straight / recta

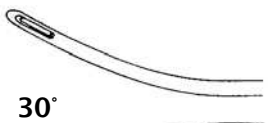

30°

Schaft gebogen / shaft curved
 vaina curva:

rechts / right / derecha

links / left / izquierda

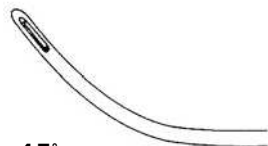

45°

rechts / right / derecha

links / left / izquierda

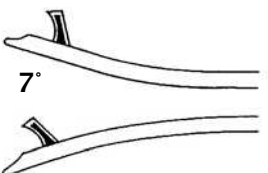
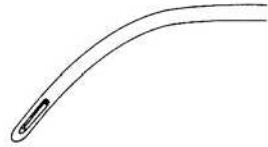

7°

aufwärts / upwards
 hacia arriba

abwärts / downwards
 hacia abajo

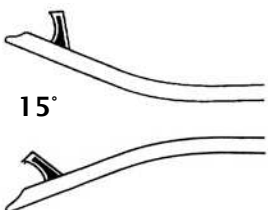

15°

aufwärts / upwards
 hacia arriba

abwärts / downwards
 hacia abajo

Standard

Duck" Form, 15°
 Duck" shaped, 15°
 pico de pato, 15°

3,4 mm Ø
 cutting size 4 x 4
 SP43-034130-000

3,4 mm Ø
 cutting size 4 x 4
 SP43-034130-200

SP43-034130-030

SP43-034130-230

SP43-034130-130

SP43-034130-330

SP43-034130-045

SP43-034130-245

SP43-034130-145

SP43-034130-345

SP43-034130-007

SP43-034130-207

SP43-034130-107

SP43-034130-307

SP43-034130-015

SP43-034130-215

SP43-034130-115

SP43-034130-315

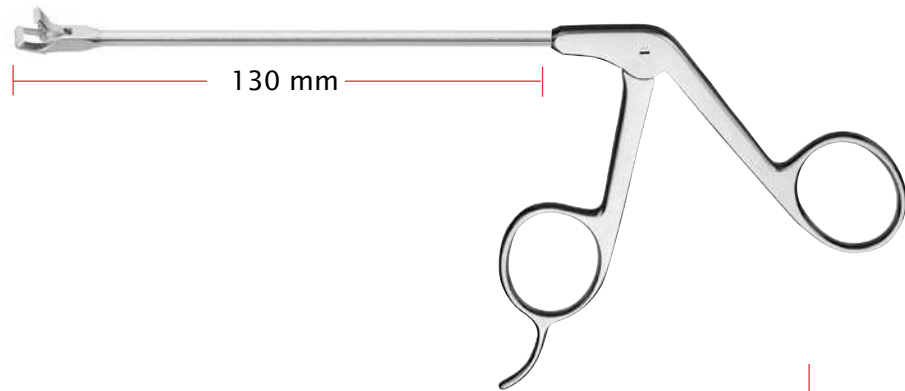

Standard



Duck

gerade / straight / recta

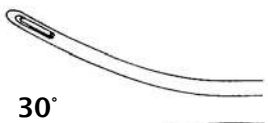

30°

Schaft gebogen / shaft curved
vaina curva:

rechts / right / derecha

links / left / izquierda



45°

rechts / right / derecha

links / left / izquierda

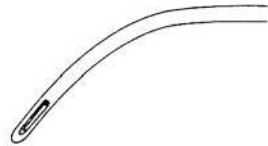

7°

aufwärts / upwards
hacia arriba

abwärts / downwards
hacia abajo

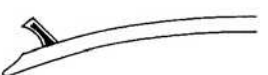

15°

aufwärts / upwards
hacia arriba

abwärts / downwards
hacia abajo



Standard

Duck“ Form, 15°
Duck“ shaped, 15°
pico de pato, 15°

3,4 mm Ø
cutting size 5 x 4,5
SP46-034130-000

3,4 mm Ø
cutting size 5 x 4,5
SP46-034130-200

SP46-034130-030

SP46-034130-230

SP46-034130-130

SP46-034130-330

SP46-034130-045

SP46-034130-245

SP46-034130-145

SP46-034130-345

SP46-034130-007

SP46-034130-207

SP46-034130-107

SP46-034130-307

SP46-034130-015

SP46-034130-215

SP46-034130-115

SP46-034130-315

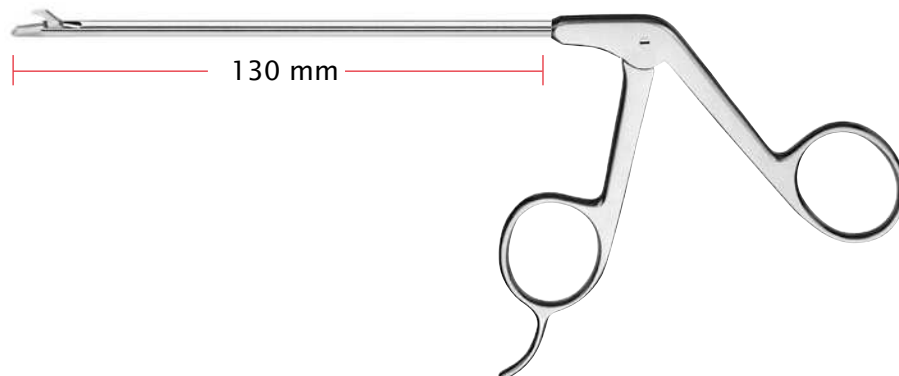

3,4 mm Ø
 cutting size 0,8 x 5.5 mm



gerade / straight / recta

SP47-034130-000



30°

Schaft gebogen / shaft curved
 vaina curva:

rechts / right / derecha

SP47-034130-030

links / left / izquierda

SP47-034130-130



45°

rechts / right / derecha

SP47-034130-045

links / left / izquierda

SP47-034130-145



7°

aufwärts / upwards
 hacia arriba

SP47-034130-007



abwärts / downwards
 hacia abajo

SP47-034130-107



15°

aufwärts / upwards
 hacia arriba

SP47-034130-015



abwärts / downwards
 hacia abajo

SP47-034130-115

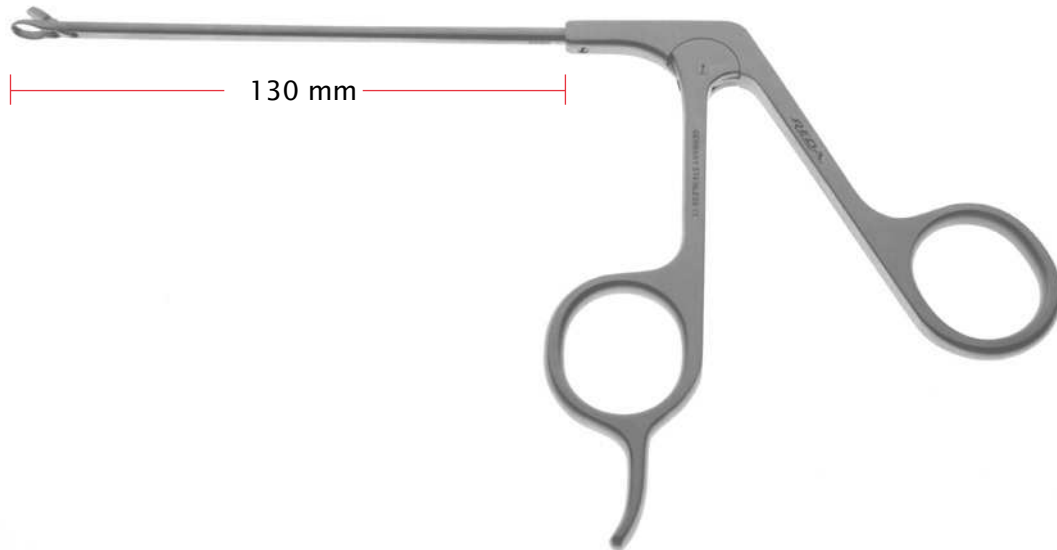

gerade / straight / recta

3,4 mm Ø
cutting size 4,4 mm

SP48-034130-000

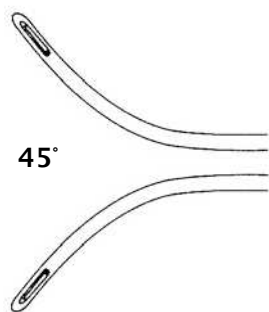

45°

rechts / right / derecha

SP48-034130-045

links / left / izquierda

SP48-034130-145



15°

aufwärts / upwards / hacia arriba

SP48-034130-015

aufgewinkelt / angled up / angulada hacia arriba

SP48-034130-200

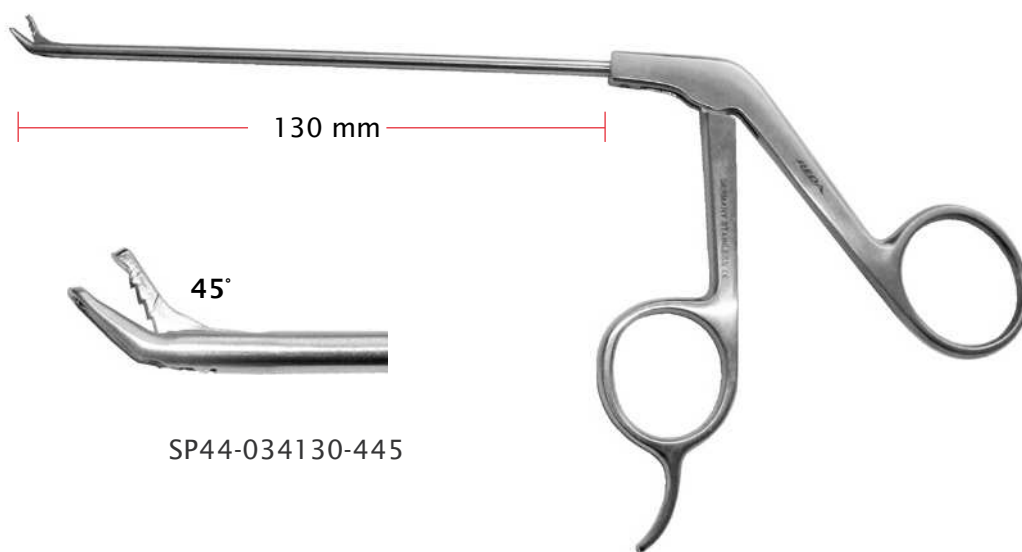

Biopsie-Stanze, 45° nach oben schneidend, 3,4 mm Ø
Biopsy punch, 45° upcurved cutting, 3.4 mm Ø
Pinza para biopsia, 45° corte hacia arriba, 3,4 mm Ø



cutting size 3,8 x 2,4

Antrumstanze durchschneidend, 3,5 mm Ø, 130 mm Nutzlänge
Antrum punch through cutting, 3.5 mm Ø, 130 mm working length
Pinza Antrum cortante, 3,5 mm Ø, largo útil de 130 mm



rechts / right / derecha

SP48-035130-600

links / left / izquierda

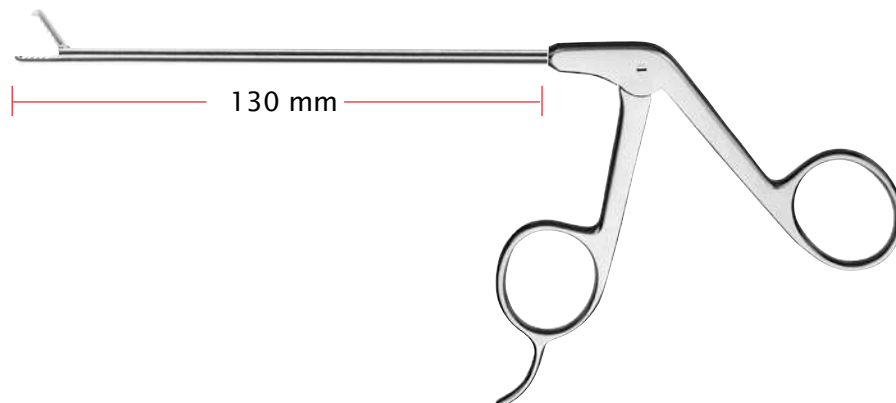
SP48-035130-800



		mit Schippe scoope nose de nariz aguda	stumpf blunt nose de nariz roma
Maulteil gewinkelt / jaw angled / boca angulada:			
 90° cutting size 5 x 1.6 mm	rechts / right / derecha	SP40-034130-590	SP41-034130-590
	links / left / izquierda	SP40-034130-790	SP41-034130-790
 45° cutting size 3,5 x 1.6 mm	rechts / right / derecha	SP40-034130-545	SP41-034130-545
	links / left / izquierda	SP40-034130-745	SP41-034130-745

Biopsie-Stanze, seitlich schneidend, breit
Biopsy punch, side-biter, wide
 Pinza para biopsia, corte lateral, ancha

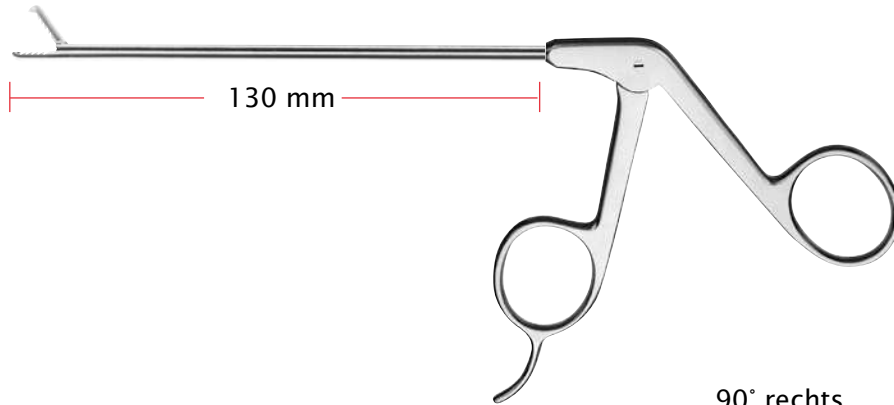

gerade / straight / recta

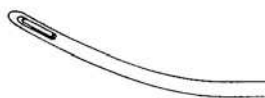

30°

Schaft gebogen / shaft curved
 vaina curva:

rechts / right / derecha

links / left / izquierda



45°

rechts / right / derecha

links / left / izquierda

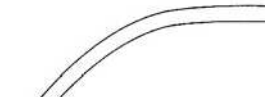

7°

aufwärts / upwards
 hacia arriba

abwärts / downwards
 hacia abajo



15°

aufwärts / upwards
 hacia arriba

abwärts / downwards
 hacia abajo



90° rechts
 90° right
 90° derecha

90° links
 90° left
 90° izquierda

3,4 mm Ø
 cutting size 4 x 4
 SP43-034130-590

3,4 mm Ø
 cutting size 4 x 4
 SP43-034130-790

SP43-034130-530

SP43-034130-730

SP43-034130-630

SP43-034130-830

SP43-034130-545

SP43-034130-745

SP43-034130-645

SP43-034130-845

SP43-034130-507

SP43-034130-707

SP43-034130-607

SP43-034130-807

SP43-034130-515

SP43-034130-715

SP43-034130-615

SP43-034130-815

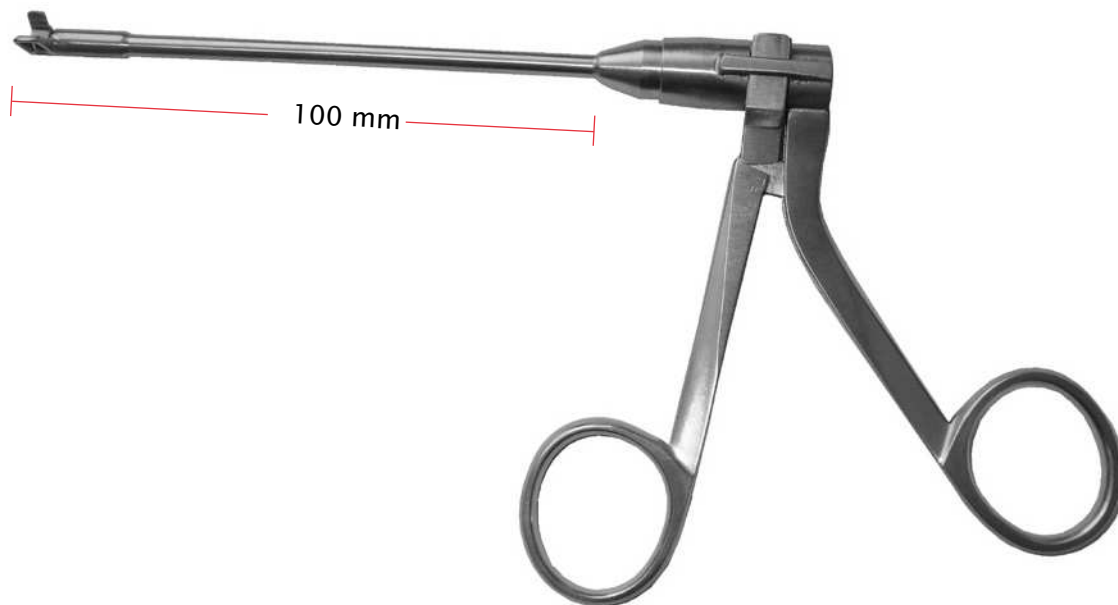

Rotationszange für große Schnitte
100 mm Nutzlänge, Ringgriff Standard

Rotary punch for big cutting size
100 mm working length, grip handle

Pinza rotatoria, para cortes grandes,
largo útil de 100 mm, mango de anillo



90° rechts / right
90° hacia la derecha

SP49-035100-090



90° links / left
90° hacia la izquierda

SP49-035100-190

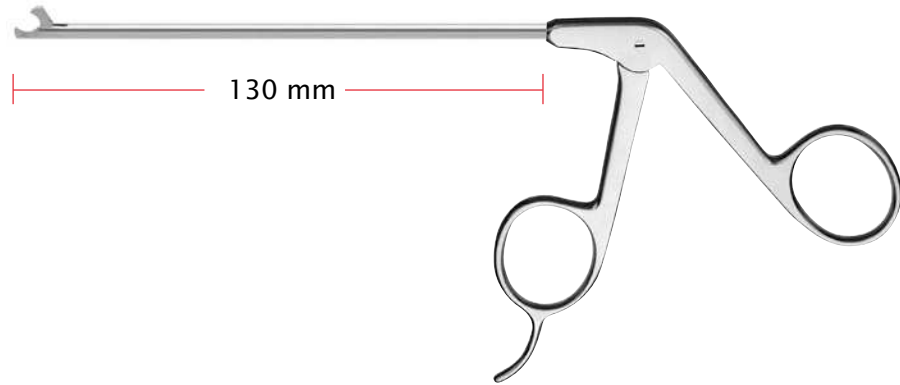

Hakenschere
 Hook scissors
 Tijera en forma de gancho

3,4 mm Ø

2,8 mm Ø

gerade / straight / recta

SP50-034130-000

SP50-028130-000



30°

Schaft gebogen / shaft curved
 vaina curva:

rechts / right / derecha

SP50-034130-030

SP50-028130-030

links / left / izquierda

SP50-034130-130

SP50-028130-130



45°

rechts / right / derecha

SP50-034130-045

SP50-028130-045

links / left / izquierda

SP50-034130-145

SP50-028130-145



45°

Maulteil gewinkelt / jaw angled
 boca angulada:

rechts / right / derecha

SP50-034130-245

links / left / izquierda

SP50-034130-345

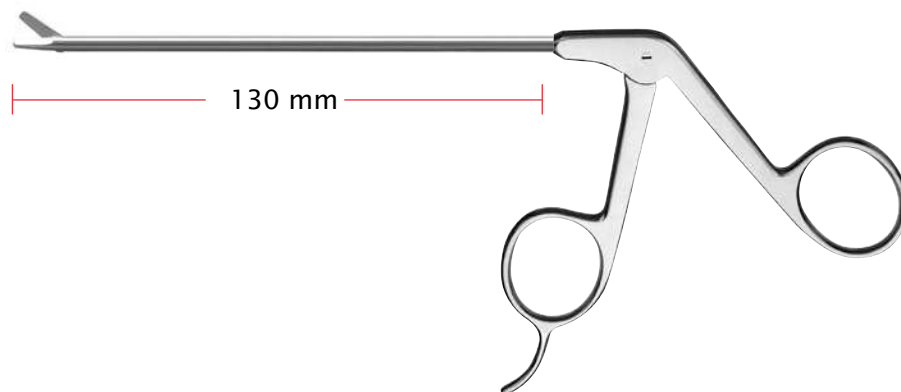

3,4 mm Ø



Schere gezahnt
Scissors serrated
Tijera dentada

gerade / straight / recta

SP51-034130-000

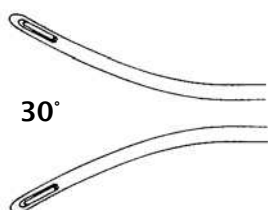

30°

Schaft gebogen / shaft curved
vaina curva:

rechts / right / derecha

SP51-034130-030

links / left / izquierda

SP51-034130-130

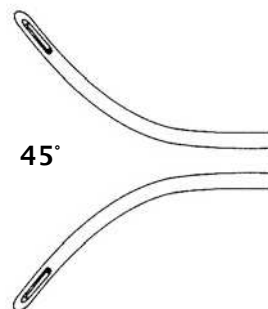

45°

rechts / right / derecha

SP51-034130-045

links / left / izquierda

SP51-034130-145

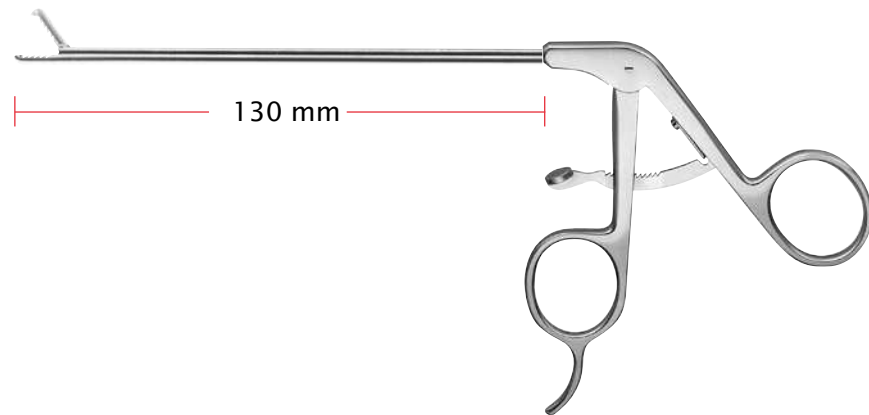

Greifzange
Alligator grasping Forceps
Pinza de agarre

3,4 mm Ø SP30-034130-000
2,8 mm Ø SP30-028130-000

Greifzange mit Sperre
Alligator grasping forceps, with ratchet
Pinza de agarre con cremallera

3,4 mm Ø SP31-034130-000
2,8 mm Ø SP31-028130-000



Faßzange mit Mauszahn
Alligator grasping forceps with mouse teeth
Pinza de agarre con diente de ratón

3,4 mm Ø SP32-034130-000
2,8 mm Ø SP32-028130-000

Faßzange, Mauszahn und Sperre
Alligator grasping forceps with mouse teeth and ratchet
Pinza de agarre con diente de ratón y cremallera

3,4 mm Ø SP33-034130-000
2,8 mm Ø SP33-028130-000



Faß-Biopsie-Zange
Grasping and biopsy forceps
Pinza de agarre y biopsia

3,4 mm Ø SP34-034130-000
2,8 mm Ø SP34-028130-000

Faß-Biopsie-Zange mit Sperre
Grasping and biopsy forceps with ratchet
Pinza de agarre y biopsia con cremallera

3,4 mm Ø SP35-034130-000
2,8 mm Ø SP35-028130-000

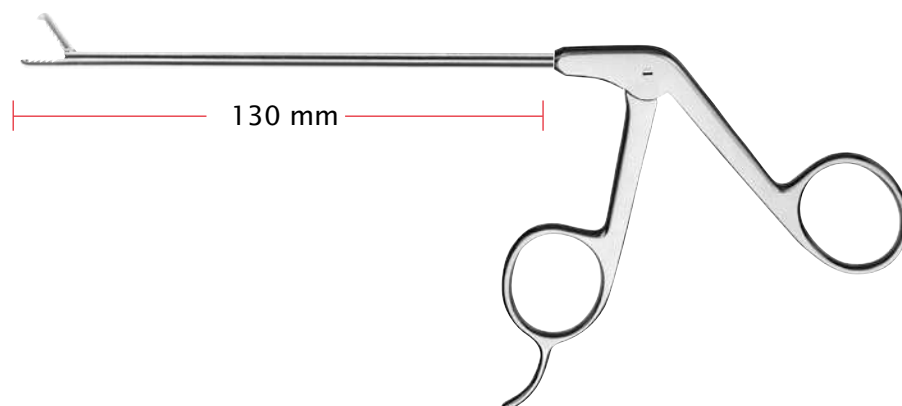

Biopsiezange
Biopsy forceps
Pinza de biopsia

3,4 mm Ø SP36-034130-000
2,8 mm Ø SP36-028130-000



Biopsiezange, mit Dorn
Biopsy forceps, with spike
Pinza de biopsia, con espina

3,4 mm Ø SP36-034130-001
2,8 mm Ø SP36-028130-001

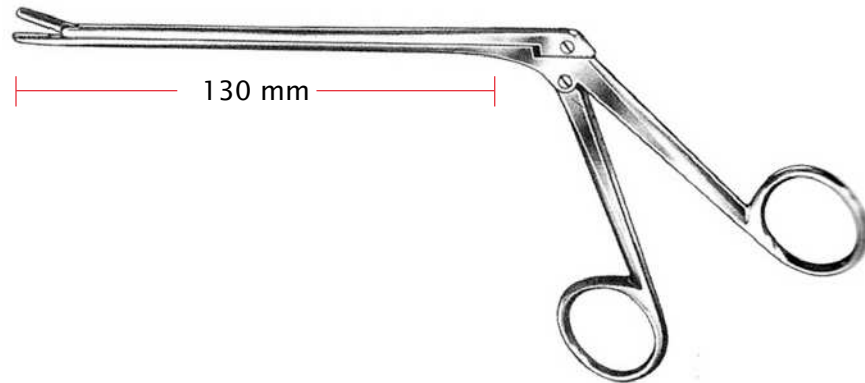

Meniskus-Faßzange kräftig
 Meniscus grasping forceps, strong
 Pinza de agarre para el menisco, fuerte

2 x 10 mm	SP36-042150-210
3 x 10 mm	SP36-042150-310
4 x 10 mm	SP36-042150-410

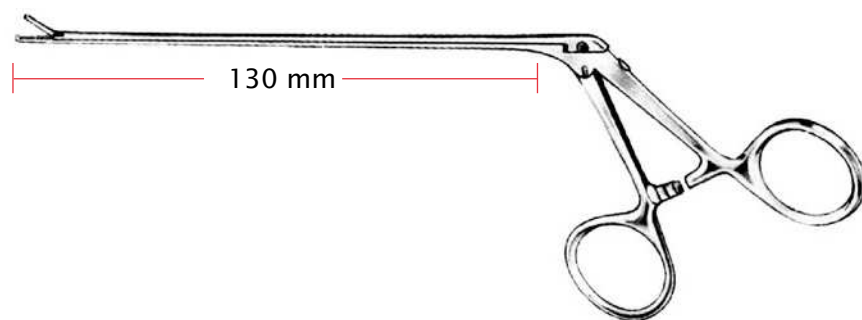

Mini-Faß-Zange mit Mauszahn und Sperre, 2,2 mm Ø
 Mini grasper with mouse teeth and ratchet, 2.2 mm Ø
 Pinza de agarre, modelo mini, con diente de ratón y cremallera, 2,2 mm Ø

SP37-022130-000

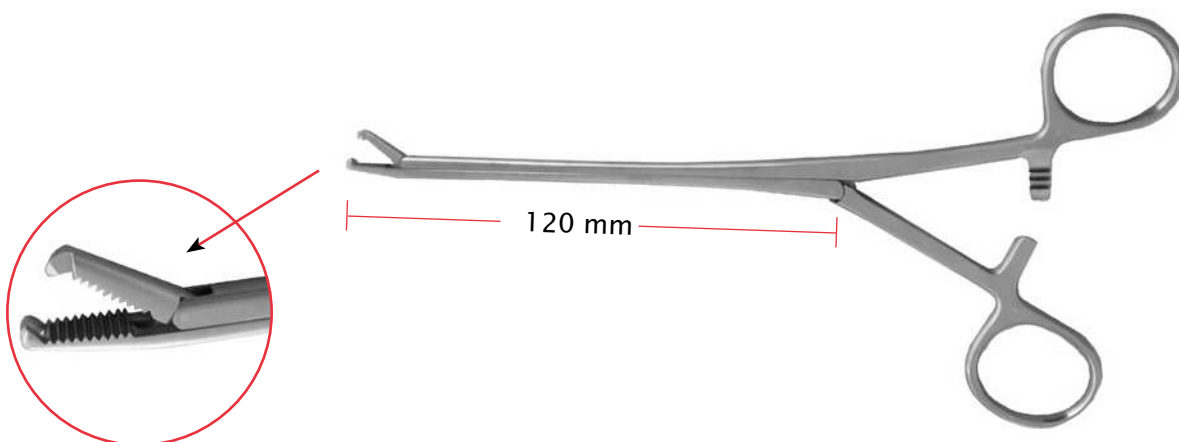

Meniskusretraktor gerade mit Mauszahn und Sperre
 Meniscus retractor straight with mouse teeth and ratchet
 Retractor de menisco, recto, con diente de ratón y cremallera

SP38-035130-000

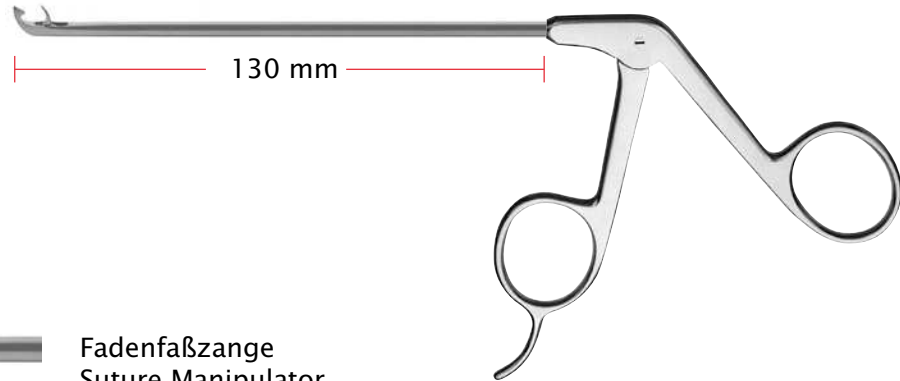

Fadenfaßzange
Suture Manipulator
pinza de agarre para sutura

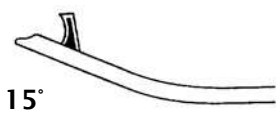

gerade / straight / recta

SP39-034130-000

15°

aufwärts / upwards
hacia arriba

SP39-034130-015

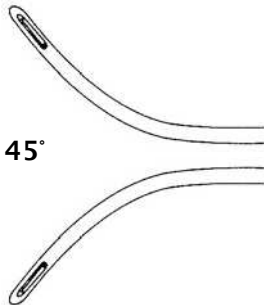

45°

rechts / right / derecha

SP39-034130-045

links / left / izquierda

SP39-034130-145



Fadenfänger gerade
Suture grasper
pinza de agarre recta

SP39-034130-100

15°

aufwärts / upwards
hacia arriba

SP39-034130-115



Faden Punch gerade
Suture punch straight
pinza de agarre recta

SP39-034130-200



45° aufwärts / upwards
45° hacia arriba

SP39-034130-300



10° aufwärts / upwards
10° hacia arriba

SP39-034130-310

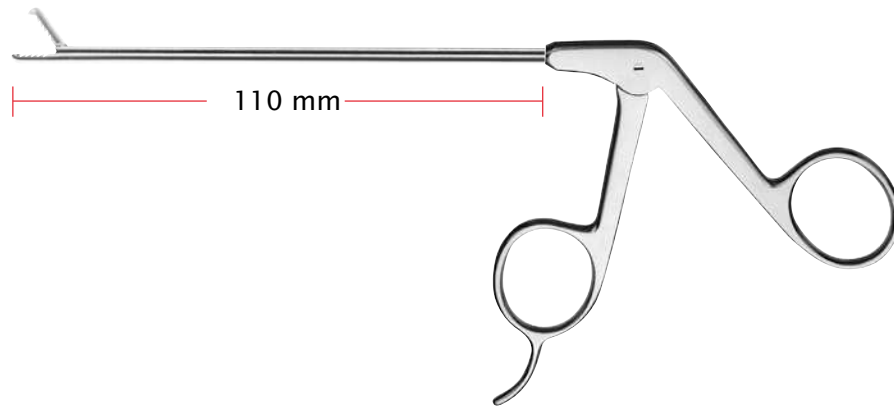

Zange mit Doppellöfel, 2 mm Ø
Forceps with double spoon, 2 mm Ø
Pinza con cucharilla doble, 2 mm Ø

SP80-020110-ART



Zange durchschneidend, 2 mm Ø
Forceps cutting through, 2 mm Ø
Pinza cortante, 2 mm Ø

SP81-020110-ART



Schere, 2 mm Ø
Scissors, 2 mm Ø
Tijera, 2 mm Ø

SP85-020110-ART



Faß-Biopsie-Zange, 2 mm Ø
Grasping and biopsy forceps, 2 mm Ø
Pinza de agarre y biopsia, 2 mm Ø

SP86-020110-ART



Greif-Zange, 2 mm Ø
Grasping Forceps, 2 mm Ø
Pinza de agarre, 2 mm Ø

SP87-020110-ART



Hakensonde graduiert
Hook probe graduated
Gancho explorador graduado
3 mm
5 mm

ART-030110-03
ART-030110-05



Skalpellmesser
Scalpel knife
Cuchillo de bisturí

ART-030110-11



Hakenmesser
Hook knife
Cuchillo en forma de gancho

ART-030110-12



Messer retrograd
Knife, retrograde
Cuchillo retrógrado

ART-030110-13

Banana-Messer
Banana knife
Cuchillo en forma de plátano



glatt / smooth / liso

ART-030110-14



gezahnt / serrated / dentado

ART-030110-15



Rosettenmesser
Rosette knife
Cuchillo en forma de roseta

ART-030110-16



Meniskotom nach Smillie
Smillie knife
Meniscótomo de Smillie

3 mm
5 mm
7 mm

ART-030110-43
ART-030110-45
ART-030110-47



Messer sichelförmig
Sickle knife
Cuchillo en forma de hoz

ART-030110-17



Löffel, 3 mm Ø
Spoon, 3 mm Ø
Cucharilla, 3 mm Ø

ART-030110-21



Ring-Kürette
Ring curette
Cureta en forma de anillo

3 mm Ø
5 mm Ø
7 mm Ø

ART-030110-31
ART-030110-32
ART-030110-33

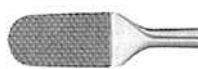

Knorpelfeile, fein
Cartilage file, fine
Lima para cartilago, fina

ART-030110-51



Knorpelfeile, grob
Cartilage file, coarse
Lima para cartilago, gruesa

ART-030110-52



instrument
Superior Quality, Trusted Precision

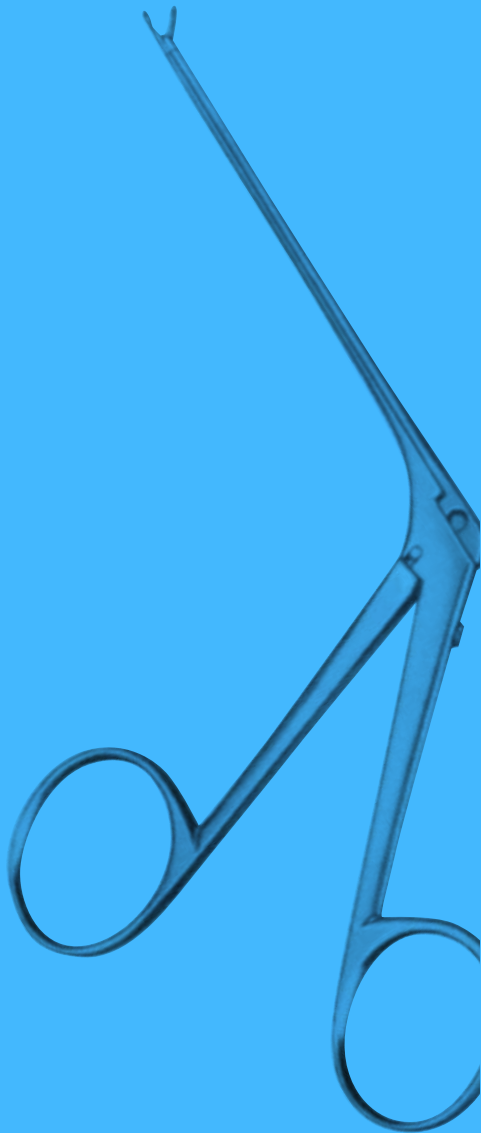

Otologie

Otology

Otología

Otologia



Wullstein
 OTO-002-040 - OTO-007-040

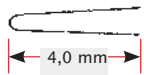

OTO-010-040 - OTO-017-040



OTO-002-040



OTO-003-040



OTO-005-040



OTO-007-040

4,0 mm x 1,0 mm
 geriefte Maulteile, gerade
serrated jaws, straight
 bocas estriadas, recta
 morsi scanalati, rette

4,0 mm x 1,0 mm
 geriefte Maulteile, aufgebogen
serrated jaws, curved up
 bocas estriadas, curva hacia arriba
 morsi scanalati, curve verso l'alto

4,0 mm x 1,0 mm
 geriefte Maulteile, rechts gebogen
serrated jaws, curved to the right
 bocas estriadas, curva a la derecha
 morsi scanalati, curve verso destra

4,0 mm x 1,0 mm
 geriefte Maulteile, links gebogen
serrated jaws, curved to the left
 bocas estriadas, curva a la izquierda
 morsi scanalati, curve verso sinistra



OTO-010-040

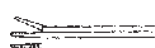

OTO-012-040

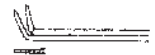

OTO-013-040



OTO-015-040

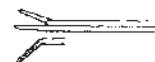

OTO-017-040

4,0 mm x 0,8 mm
 glatt, gerade
smooth, straight
 lisa, recta,
 liscia, retta

4,0 mm x 0,8 mm
 gerieft, gerade
serrated, straight
 estriada, recta,
 con scanalura, retta

4,0 mm x 0,8 mm
 aufgebogen, gerieft
bent upwards, serrated
 curva por arriba, estriada
 curva in alto, con scanallatura

4,0 mm x 0,8 mm
 rechts, gerieft
right, serrated
 derrecha, estriada
 estra, con scanallatura

4,0 mm x 0,8 mm
 links, gerieft
left, serrated
 izquierda, estriada
 sinistra, con scanallatura

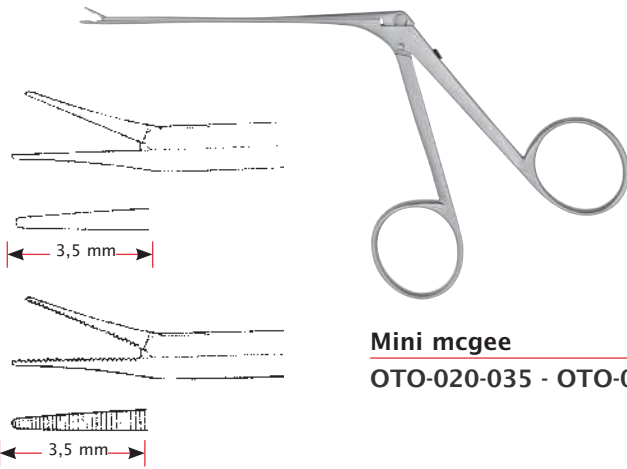

Mini mcgee
OTO-020-035 - OTO-022-035



OTO-020-035



OTO-022-035

3,5 mm x 0,6 mm
glatt, gerade
smooth, straight
lisa, recta
liscia, retta

3,5 mm x 0,6 mm
gerieft, gerade
serrated, straight
estriada, recta
con scanalatura, retta



OTO-030-040

4,0 mm x 0,6 mm
glatt, gerade
smooth, straight
lisa, recta
liscia, retta

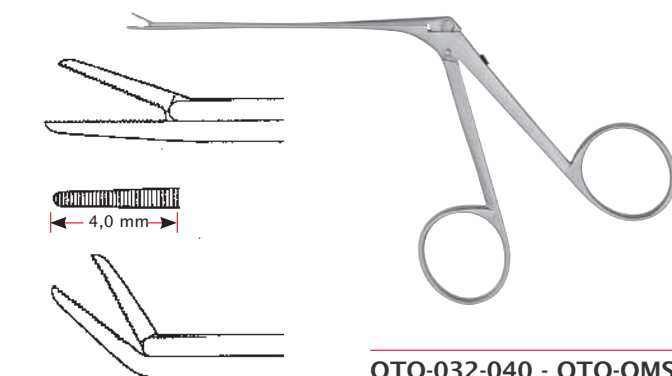

OTO-032-040 - OTO-OMS-040



OTO-032-040



OTO-033-040

4,0 x 0,6 mm
gerieft, gerade
serrated, straight
estriada, recta,
con scanalura, retta

4,0 x 0,6 mm
aufgebogen, gerieft
bent upwards, serrated
curva por arriba, estriada
curva in alto, con scanallatura



OTO-RGY-040



OTO-OMS-040

4,0 x 0,6 mm
rechts, gerieft
right, serrated
derrecha, estriada
estra, con scanallatura

4,0 x 0,6 mm
links, gerieft
left, serrated
izquierda, estriada
sinistra, con scanallatura

1,0 x 0,9 mm
 Loffel
cup
 cucharilla
 cucchiaio

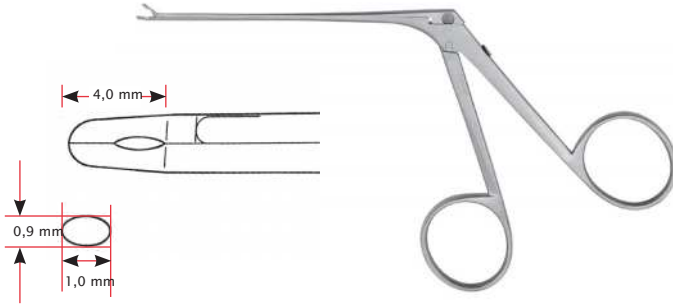

OTO-040-040 - OTO-047-040



4,0 mm
 gerade
straight
 recta
 retta

OTO-040-040



4,0 mm
 aufgebogen
curved up
 curva por arriba
 curva in alto

OTO-043-040



4,0 mm
 rechts
right
 derecha
 destra

OTO-045-040



4,0 mm
 links
left
 izquierda
 sinistra

OTO-047-040

0,6 x 0,5 mm
 Loffel
cup
 cucharilla
 cucchiaio

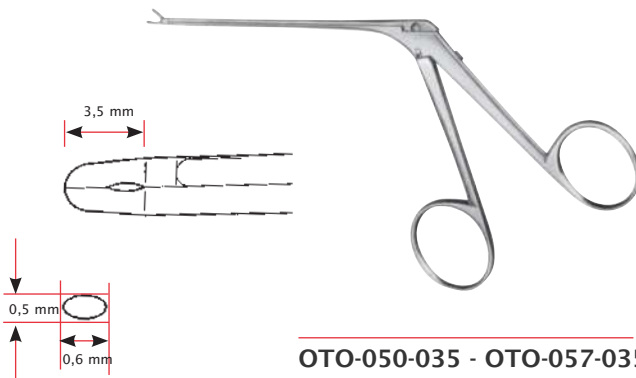

OTO-050-035 - OTO-057-035



3,5 mm
 gerade
straight
 recta
 retta

OTO-050-035

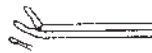

3,5 mm
 aufgebogen
curved up
 curva por arriba
 curva in alto

OTO-053-035



3,5 mm
 rechts
right
 derecha
 destra

OTO-055-035

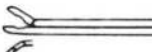

3,5 mm
 links
left
 izquierda
 sinistra

OTO-057-035

sehr fein
very fine
muy fina
molto delicata



Bellucci
OTO-060-040 - OTO-067-040



gerade
straight
recta,
retta

OTO-060-040



aufgebogen
curved up
curva por arriba
curva in alto

OTO-063-040



rechts
right
derecha
destra

OTO-065-040



links
left
izquierda
sinistra

OTO-067-040

0,8 mm
Schaft
shaft
vástago
gambo

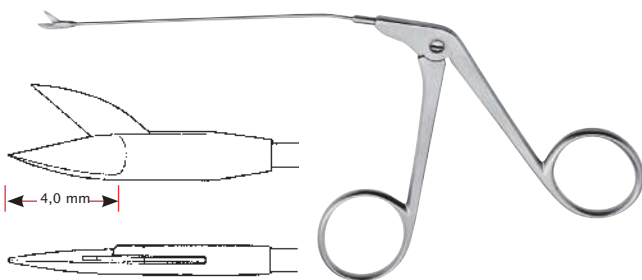

Wullstein
OTO-070-040 - OTO-077-040



gerade
straight
recta
retta

OTO-070-040



aufgebogen
curved up
curva por arriba
curva in alto

OTO-073-040

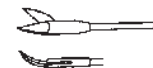

rechts
right
derecha
destra

OTO-075-040

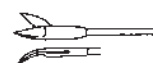

links
left
izquierda
sinistra

OTO-077-040

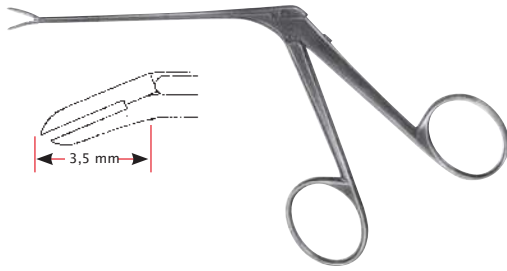

Mc gee
 OTO-081-035 - OTO-081-060

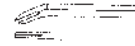

3,5 x 0,8 mm
 abgebogen
curved downward
 curva por abajo
 curva in basso

OTO-081-035



6,0 x 0,8 mm
 abgebogen
curved downward
 curva por abajo
 curva in basso

OTO-081-060



Wullstein
 OTO-082-010 - OTO-087-010



runde Maulteile, ø 1,0 mm, gerade
round cup jaws, ø 1,0 mm, straight
 copas redondas, ø 1,0 mm, recta
 morsi rotondi, ø 1,0 mm, retta

OTO-082-010



runde Maulteile, ø 1,0 mm, aufgebogen
round cup jaws, ø 1,0 mm, curved up
 copas redondas, ø 1,0 mm, curva hacia arriba
 morsi rotondi, ø 1,0 mm, curve verso l'alto

OTO-083-010



runde Maulteile, ø 1,0 mm, rechts gebogen
round cup jaws, ø 1,0 mm, curved to the right
 copas redondas, ø 1,0 mm, curva a la derecha
 morsi rotondi, ø 1,0 mm, curve verso destra

OTO-085-010



runde Maulteile, ø 1,0 mm, links gebogen
round cup jaws, ø 1,0 mm, curved to the left
 copas redondas, ø 1,0 mm, curva a la izquierda
 morsi rotondi, ø 1,0 mm, curve verso sinistra

OTO-087-010

Hammerkopfzängchen
 Malleus Nipper
 Pinza para cabezal del malèolo
 Pinz per testa del martelletto

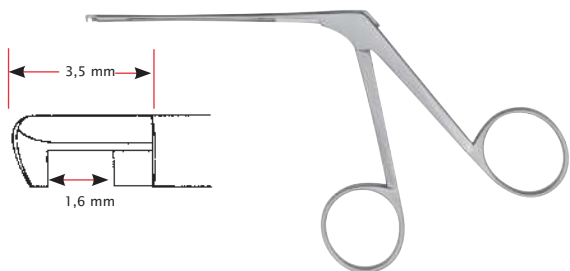

hOusE-diEtEr
 OTO-091-035 - OTO-093-035

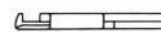

3,5 x 1,6 mm
 oben schneidend
up-cutting
 corte arriba
 tagliente in alto

OTO-091-035

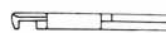

3,5 x 1,6 mm
 unten schneidend
down-cutting
 corte abajo
 tagliente in basso

OTO-093-035

Hammerkopfzängchen
Malleus Nipper
Pinza para cabezal del malèolo
Pinz per testa del martelletto

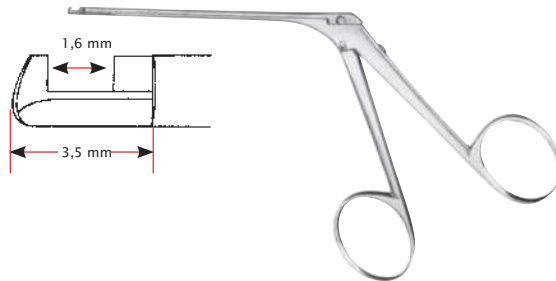

House-dieter
OTO-095-035 - OTO-097-035

3,5 mm x 1,6 mm
rechts schneidend
right-cutting
corte derecho
tagliante a destra

OTO-095-035

3,5 mm x 1,6 mm
links schneidend
left-cutting
corte izquierdo
tagliante a sinistra

OTO-097-035

Einführungszängchen
Introducing Forceps
Pinza para introducir
Pinza per introduzione

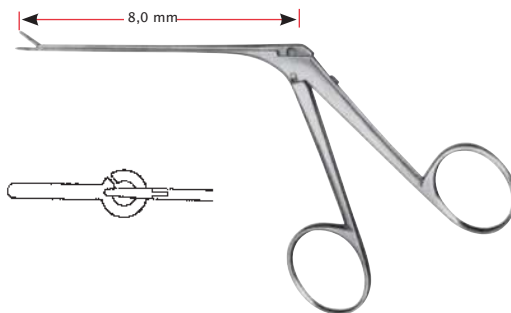

Fuller
OTO-100-080



Wullstein
OTO-102-010 - OTO-107-010



OTO-102-010

ovale Maulteile, ø 1,0 mm, gerade
oval cup jaws, ø 1,0 mm, straight
copas ovales, ø 1,0 mm, recta
morsi ovali, ø 1,0 mm, retta



OTO-103-010

ovale Maulteile, ø 1,0 mm, aufgebogen
oval cup jaws, ø 1,0 mm, curved up
copas ovales, ø 1,0 mm, curva hacia arriba
morsi ovali, ø 1,0 mm, curve verso l'alto



OTO-105-010

ovale Maulteile, ø 1,0 mm, rechts gebogen
oval cup jaws, ø 1,0 mm, curved to the right
copas ovales, ø 1,0 mm, curva a la derecha
morsi ovali, ø 1,0 mm, curve verso destra



OTO-107-010

ovale Maulteile, ø 1,0 mm, links gebogen
oval cup jaws, ø 1,0 mm, curved to the left
copas ovales, ø 1,0 mm, curva a la izquierda
morsi ovali, ø 1,0 mm, curve verso sinistra



Schuknecht

OTO-111-160 16,0 cm / 6 1/4"

Rollenmesser
Rotary Knife
 Cuchillo redondo
 Coltello rotondo



Schuknecht

OTO-113-160 16,0 cm / 6 1/4"

Sichelmesser
Sickle Knife
 Cuchillos de hoz
 Coltello falcato come sinechia



Wullstein

OTO-115-160 16,0 cm / 6 1/4"

Sichelmesser
Sickle Knife
 Cuchillos de hoz
 Coltello falcato come sinechia



Tabb

OTO-117-160 16,0 cm / 6 1/4"

Schleimhautmesser
Mucosa Knife
 Cuchillo para mucosa
 Coltello per mucosa



Plester

OTO-119-160 16,0 cm / 6 1/4"

Lappenmesser
Flap Knife
 Cuchillo para lóbulos
 Coltello per lobi



Rosen

OTO-121-001 - 032-121-007 16,0 cm / 6 1/4"

Rundschnittmesser
Circular Cut Knives
 Cuchillos para cortes redondos
 Coltelli circolari

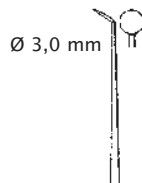

Fig. 1
OTO-121-001

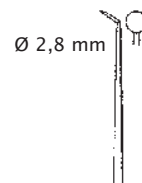

Fig. 2
034-121-002

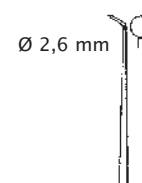

Fig. 3
OTO-121-003

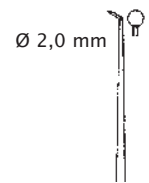

Fig. 4
OTO-121-004

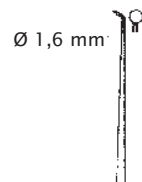

Fig. 5
OTO-121-005

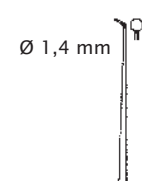

Fig. 6
OTO-121-006

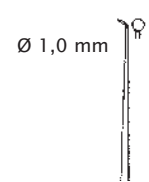

Fig. 7
OTO-121-007



Barbara
OTO-125-001



Barbara
OTO-125-002



Barbara
OTO-125-003



Rosen
OTO-125-004



Barbara
OTO-131-003 0,3 mm
OTO-131-006 0,6 mm
OTO-131-010 1,0 mm



Barbara
OTO-133-003 0,3 mm
OTO-133-006 0,6 mm
OTO-133-010 1,0 mm
OTO-133-012 1,2 mm
OTO-133-015 1,5 mm
OTO-133-020 2,0 mm
OTO-133-025 2,5 mm



Barbara
OTO-135-003 0,3 mm
OTO-135-006 0,6 mm
OTO-135-010 1,0 mm
OTO-135-012 1,2 mm
OTO-135-015 1,5 mm
OTO-135-020 2,0 mm
OTO-135-025 2,5 mm



Barbara
OTO-137-005 0,5 mm
OTO-137-010 1,0 mm



OTO-125-001 - OTO-137-010 16,0 cm / 6¹/₄"

Mikro-Ohrnadeln, Mikro-Ohrhäkchen

Micro Ear needles, Micro Ear hooks

Micro agujas auriculares, Mirco ganchitos auriculares

Micro aghi auricolari, Micro uncini auricolari



OTO-139-0030,3 mm
OTO-139-0060,6 mm
OTO-139-0101,0 mm



OTO-141-0030,3 mm
OTO-141-0060,6 mm
OTO-141-0101,0 mm



Mc Gee

OTO-143-0050,5 mm
OTO-143-0101,0 mm



Mc Gee

OTO-145-0050,5 mm
OTO-145-0101,0 mm



Barbara

OTO-147-155



Rosen

OTO-149-155

OTO-139-003 - OTO-149-155 15,5 cm / 6"



OTO-151-003 0,3 mm



OTO-151-006 0,6 mm



OTO-151-010 1,0 mm



OTO-153-003 0,3 mm



OTO-153-006 0,6 mm



OTO-153-010 1,0 mm

OTO-151-003 - OTO-153-010 15,5 cm / 6"



45°



stumpf
blunt
romo
smusso

Shea

OTO-155-020 2,0 mm

Sondierhaken
Exploring Hook
ganchito explorador
Uncino di sondaggio



90°

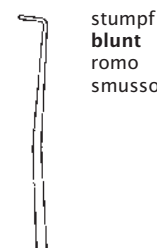

stumpf
blunt
romo
smusso

Austin

OTO-157-030 3,0 mm

Attikusdissektor
Attic Dissector
Disecador para el ático
Dissettore per l'attico



nach rechts abgewinkelt
angled to right
 angulada por derecha
 angulata a destra

OTO-161-001



nach links abgewinkelt
angled to left
 angulada por izquierda
 angulata a sinistra

OTO-161-002



nach rechts abgewinkelt
angled to right
 angulada por derecha
 angulata a destra

OTO-163-001



nach links abgewinkelt
angled to left
 angulada por izquierda
 angulata a sinistra

OTO-163-002

Fisch

OTO-161-001 - OTO-163-002 15,5 cm / 6"



2,0 mm

Rosen

OTO-165-155 15,5 cm / 6"

Mikro-Ohrspatorium
Micro Ear Periosteal Elevator
 Micro legra auricular
 Micro Raspatore auricolare



House

OTO-170-035 - OTO-170-050 15,5 cm / 6"

Mikro-Messsonde
Micro Measuring Rod
 Micro sonda para medir
 Micro Sonda per misurare



OTO-170-035 3,5 mm



OTO-170-040 4,0 mm



OTO-170-045 4,5 mm



OTO-170-050 5,0 mm

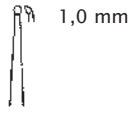

1,0 mm

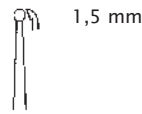

1,5 mm

OTO-180-001

OTO-180-002

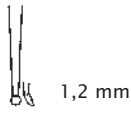

1,2 mm

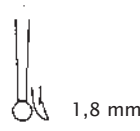

1,8 mm

House

OTO-180-001 - OTO-180-002 15,0 cm / 6"

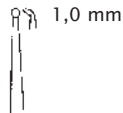

1,0 mm

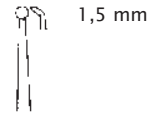

1,5 mm

OTO-181-001

OTO-181-002

stark abgewinkelt
strong angled
angulada fuerte
angulata forte

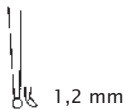

1,2 mm

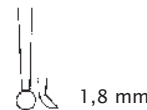

1,8 mm

House

OTO-181-001 - OTO-181-002 15,0 cm / 6"



Tilley
 OTO-401-140 4,0 cm / 5½"



Littauer
 OTO-403-120 2,0 cm / 4¾"



feines Modell
fine model
 modelo fino
 modello fino

Hartmann
 OTO-405-120 2,0 cm / 4¾"



Hartmann
 OTO-407-140 4,0 cm / 5½"

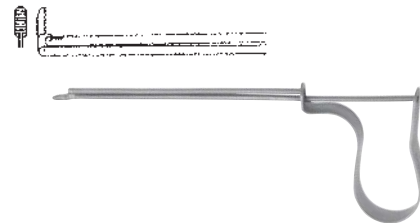

Quire
 OTO-410-100 0,0 cm / 4¾"

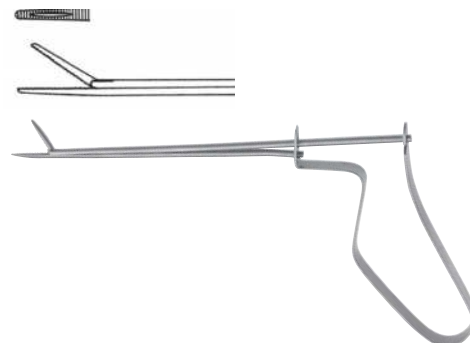

Buck
 OTO-412-110 1,0 cm / 4¾"

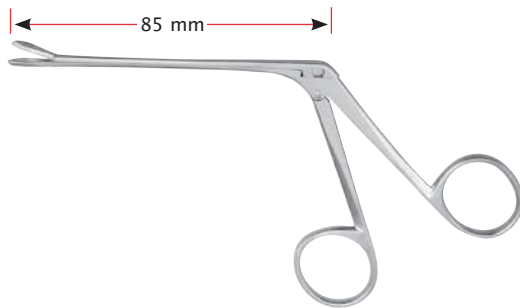

Hartmann-wullstein
OTO-420-085 8,5 cm

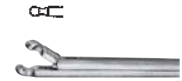

Hartmann-wullstein
OTO-422-085 Ø 1,0 mm/ 8,5 cm



Hartmann
OTO-424-085 8,5 cm



Hartmann
OTO-426-085 8,5 cm

Hartmann
OTO-424-140 14,0 cm / 5 1/2"

Schaftlänge 140 mm
Shaft length 140 mm
longitud del vástago 140 mm
lunghezza del gambo 140 mm

Hartmann
OTO-426-140 14,0 cm / 5 1/2"

Schaftlänge 140 mm
Shaft length 140 mm
longitud del vástago 140 mm
lunghezza del gambo 140 mm

Hartmann
OTO-424-160 16,0 cm / 6 1/4"

Schaftlänge 160 mm
Shaft length 160 mm
longitud del vástago 160 mm
lunghezza del gambo 160 mm

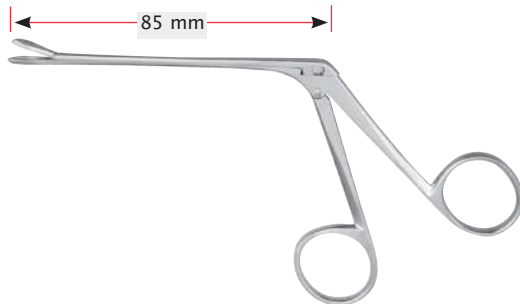

Hartmann
OTO-430-020 8,5 cm / 3 1/4"



Strümpel
OTO-434-085 8,5 cm / 3 1/4"



Hartmann
OTO-430-025 8,5 cm / 3 1/4"



hartMann-hOFFMann
OTO-438-085 8,5 cm / 3 1/4"



Hartmann
OTO-430-030 8,5 cm / 3 1/4"

Ohr-Knochenstanzen
Mastoid rongeurs
Pinzas cortantes para huesos
Pinze osteomi



||

OTO-450-015 1,5 mm

||

OTO-450-020 2,0 mm

||

OTO-450-030 3,0 mm

Citelli

OTO-450-015 - OTO-450-030 17,0 cm / 6 3/4"



1 mm Schnitt
1 mm cut
corte 1 mm
taglio 1 mm

Beyer

OTO-452-001 4,0 cm / 5 1/2"



2 mm Schnitt
2 mm cut
corte 2 mm
taglio 2 mm

Beyer

OTO-452-002 9,0 cm / 7 1/2"



stumpf
blunt
romo
smusso

Langenbeck

OTO-501-130 3,0 cm / 5 "



OTO-503-001



OTO-503-002

Shapleigh

OTO-503-001 - OTO-503-002 15,0 cm / 6"



gerade stumpf
straight blunt
recto romo
retto smusso



Fig. 00

OTO-510-002



Fig. 0

OTO-510-010



Fig. 1

OTO-510-011



Fig. 2

OTO-510-012



Fig. 3

OTO-510-013



Fig. 4

OTO-510-014



Fig. 5

OTO-510-015



Fig. 00

OTO-512-002



Fig. 0

OTO-512-010



Fig. 1

OTO-512-011



Fig. 2

OTO-512-012



Fig. 3

OTO-512-013



Fig. 4

OTO-512-014



Fig. 5

OTO-512-015



gerade scharf
straight sharp
recto agudo
retto acuto

Buck

OTO-510-002 - OTO-512-015



gebogen stumpf
curved blunt
 curva romo
 curvo smusso



Fig. 00
OTO-515-002



Fig. 0
OTO-515-010



Fig. 1
OTO-515-011



Fig. 2
OTO-515-012



Fig. 3
OTO-515-013



Fig. 4
OTO-515-014



Fig. 5
OTO-515-015



gebogen scharf
curved sharp
 curva agudo
 curvo acuto



Fig. 00
OTO-517-002



Fig. 0
OTO-517-010



Fig. 1
OTO-517-011



Fig. 2
OTO-517-012



Fig. 3
OTO-517-013



Fig. 4
OTO-517-014



Fig. 5
OTO-517-015



Buck
OTO-515-002 - OTO-517-015



Jansen
OTO-521-150 15,0 cm / 6"

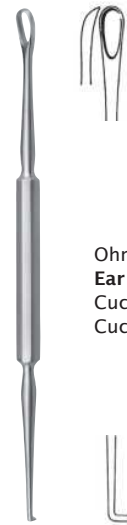

Gross
OTO-523-120 12,0 cm / 4³/₄"

Ohrlöffel und Häkchen
Ear Scoop/Hook
 Cucharilla/ganchito auricular
 Cucchiaio auricolare



klein
small
pequeño
piccolo

OTO-530-001



mittel
medium
mediano
medio

OTO-530-002



groß
large
grande
grande

OTO-530-003

Billeau

OTO-530-001 - OTO-530-003 16,0 cm / 6 1/4"

Ohrschlinge
Ear Loop
Asa auricular
Ansa auricolare



Fig.0

OTO-532-000



Fig.1

OTO-532-001



Fig.2

OTO-532-002

Weber-loch

OTO-532-000 - OTO-532-002 14,5 cm / 5 3/4"

Ohrschlinge
Ear Loop
Asa auricular
Ansa auricolare



Moldenhauer

OTO-541-165 6,5 cm / 6 1/2"

Fremdkörperheber
Foreign Body Lever
Elevador para cuerpos extraños
Leva per corpi estranei



Zaufal

OTO-543-160 6,0 cm / 6 1/2"

Fremdkörperheber
Foreign Body Lever
Elevador para cuerpos extraños
Leva per corpi estranei



Hartmann

OTO-545-160 6,0 cm / 6 "

Ohrhäkchen
Ear Hooklet
ganchito auricular
Uncino auricolare



Lucae

OTO-551-001 - OTO-551-003 14,0 cm / 5½"



OTO-551-001

klein
small
 pequeño
 piccolo



OTO-551-002

mittel
medium
 mediano
 medio



OTO-551-003

groß
large
 grande
 grande



Day

OTO-553-001 - OTO-553-002 16,0 cm / 6¾"



OTO-553-001



OTO-553-002



Wagner

OTO-555-001 - OTO-555-004 14,0 cm / 5½"



Flg. 1

OTO-555-001



Flg. 2

OTO-555-002



Flg. 3

OTO-555-003



Flg. 4

OTO-555-004



Politzer
OTO-561-160 16,0 cm / 6 1/2"



Nadel quergestellt
needle horizontally
aguja en posición horizontal
ago orizzontale

Politzer
OTO-563-160 16,0 cm / 6 1/4"



Politzer
OTO-565-150 15,0 cm / 6"
Furunkelmesser
Furuncle Knife
cuchillo para furúnculos
Coltello per foruncoli



Politzer
OTO-566-180 18,0 cm / 7"



Lucae
OTO-571-180 18,0 cm / 7"



Lucae
OTO-573-180 18,0 cm / 7"

Ohrspatorien, ohrlöffel
Ear periosteal elevators, ear scoops
 Legras auriculares, cucharillas auriculares
 Raspatori auricolari, Curette auricolari







Lempert
 OTO-581-205 20,5 cm / 8"



Lempert
 OTO-583-180 18,0 cm / 7"



				
<u>Fig. 0</u>	<u>Fig. 00</u>	<u>Fig. 1</u>	<u>Fig. 2</u>	<u>Fig. 3</u>
OTO-590-010	OTO-590-020	OTO-592-001	OTO-592-002	OTO-592-003

Lempert
 OTO-590-010 - OTO-592-003 20,0 cm / 8"



instrument

Superior Quality, Trusted Precision

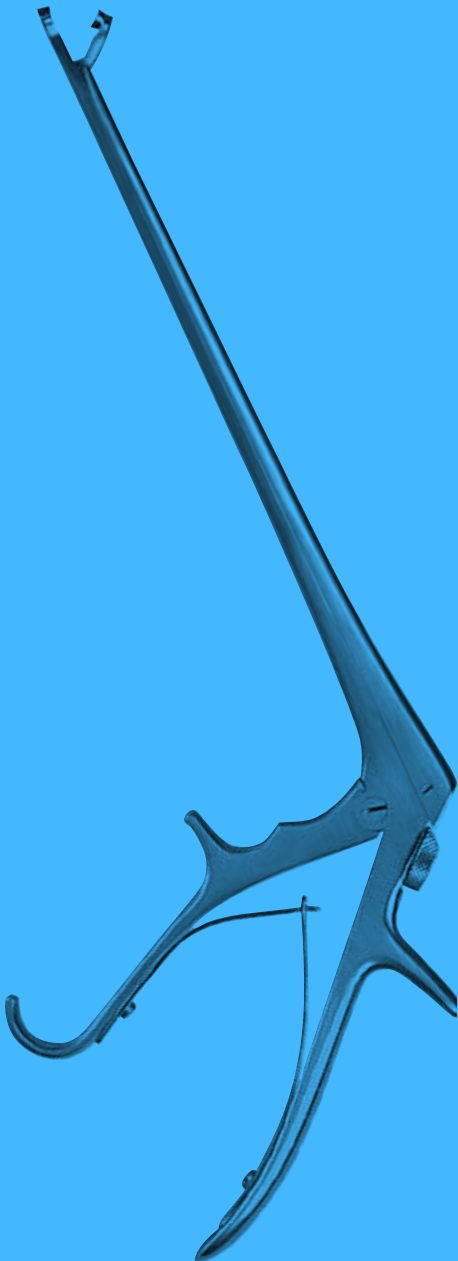

Gynäkologie, Geburtshilfe

Gynecology, Obstetrics

Ginecología, Ostetricia

Ginecologia, Ostetricia

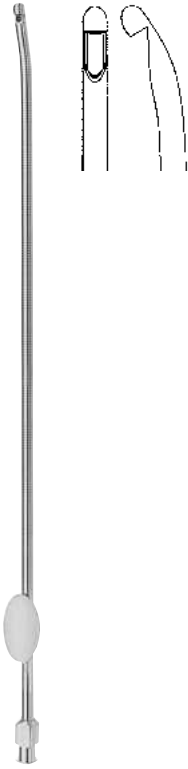

Randall
 030-451-230 23,0 cm / 9" Ø 4,0 mm

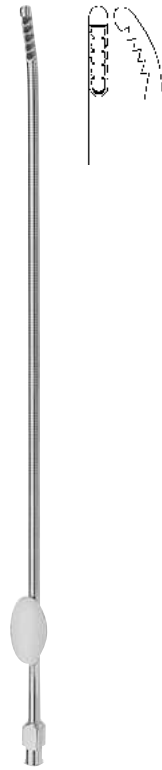

Novak
 030-453-002 23,0 cm / 9" Ø 2 mm
 030-453-004 23,0 cm / 9" Ø 4 mm



Kevorkian
 030-456-300 30,0 cm / 12"



Kevorkian
 030-458-300 30,0 cm / 12"



Kevorkian
 030-460-300 30,0 cm / 12"



Gellhorn
030-501-230 23,0 cm / 9"



Faure
030-503-210 21,0 cm / 8 1/4"

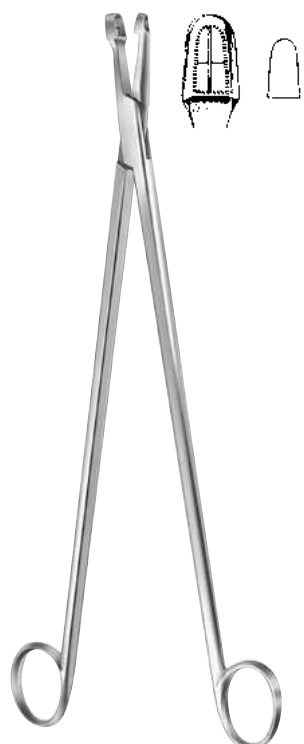

Schubert
030-506-210 21,0 cm / 8 1/4"
030-506-290 29,0 cm / 11 1/2"

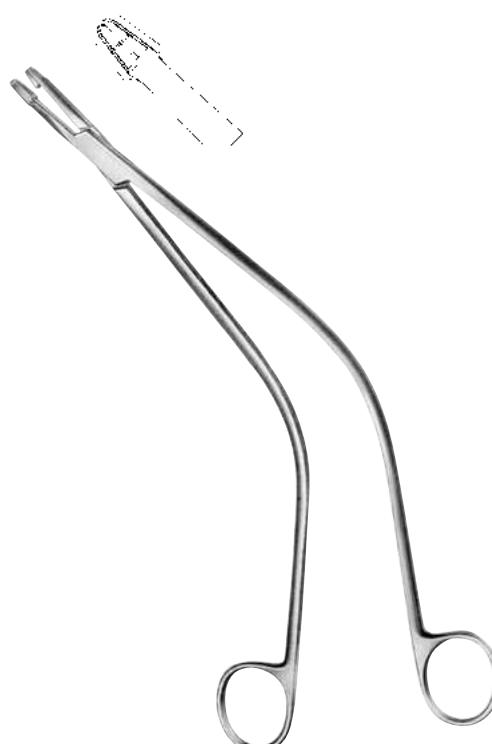

Schubert
030-509-260 26,0 cm / 10 1/4"



Thoms-gaylor

030-511-220 22,0 cm / 8³/₄"
 030-511-240 24,0 cm / 9¹/₂"

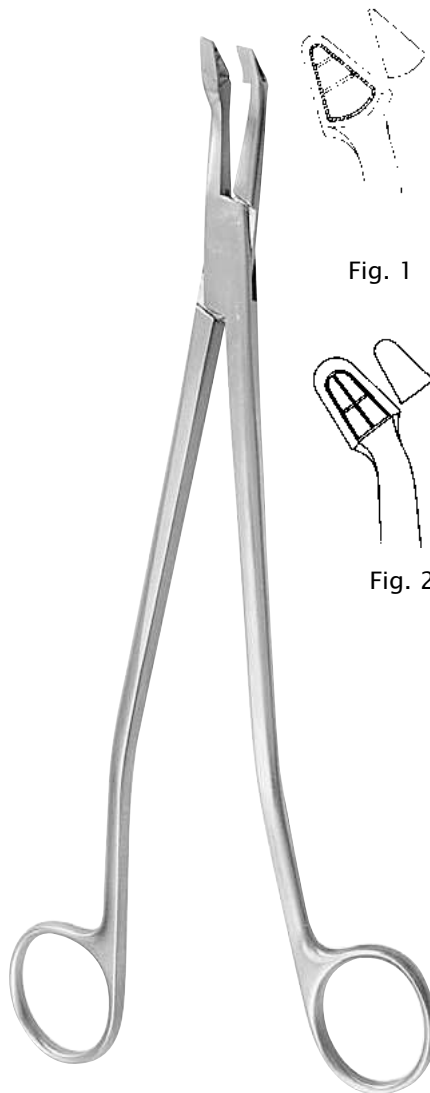

Fig. 1

Fig. 2

Van doren

030-515-001 25,0 cm / 9³/₄" Fig. 1
 030-515-002 25,0 cm / 9³/₄" Fig. 2



Van doren

030-517-002 25,5 cm / 10"

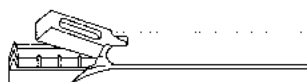
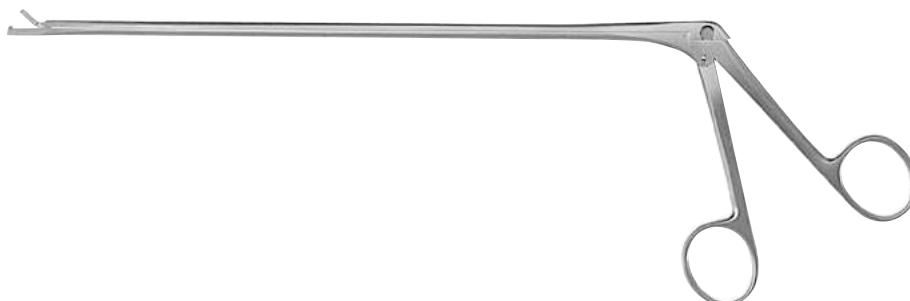

Kevorkian

030-520-250 25,0 cm / 10³/₈ x 9 mm

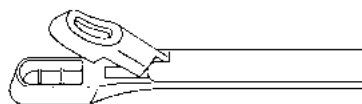

Eppendorfer

030-524-200 20,0 cm / 8" 4x8 mm

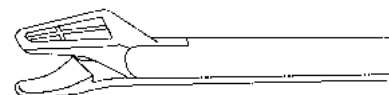

Alexander

030-526-280 28,0 cm / 11"

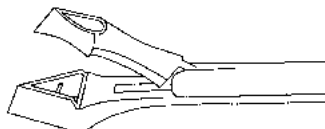

Schumacher

030-530-001 24,0 cm / 9¹/₂" 4,5x7 mm

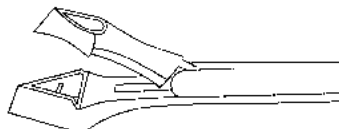

Schumacher

030-530-002 24,0 cm / 9¹/₂" 6x9 mm

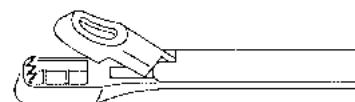

Wittner

030-532-230 23,0 cm / 9" 4,5x8 mm



Wittner

030-533-230 23,0 cm / 9" 4,5x8 mm

Uterus Biopsiezangen
Cervical Biopsy and Specimen Forceps
Pinzas saca-bocados para biopsia
Pinze per la biopsia cervicale e da prelievo

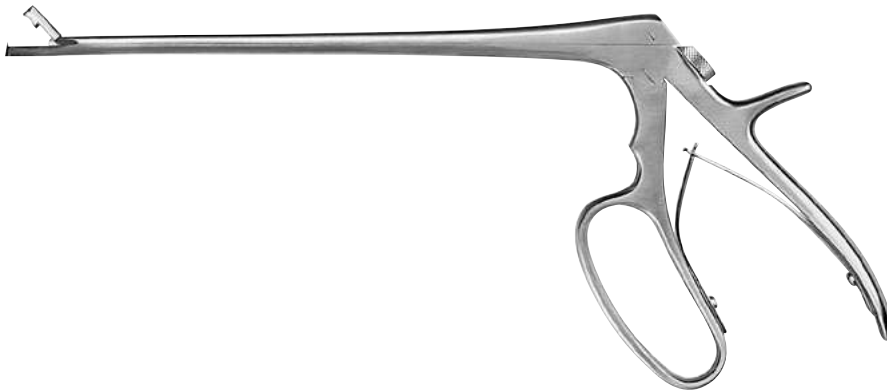

Tischler-morgan

030-550-210 21,0 cm / 8¹/₄ 7x3 mm
030-550-250 25,0 cm / 9³/₄ 7x3 mm



Mini-townsend

030-552-210 21,0 cm / 8¹/₄ 2,3x5 mm



Baby-tischler

030-554-210 21,0 cm / 8¹/₄ 2,3x5 mm



Tischler-kevorkian

030-556-210 21,0 cm / 8¹/₄ 3x9 mm



Kevorkian-pacific

030-558-210 21,0 cm / 8¹/₄ 3x8 mm

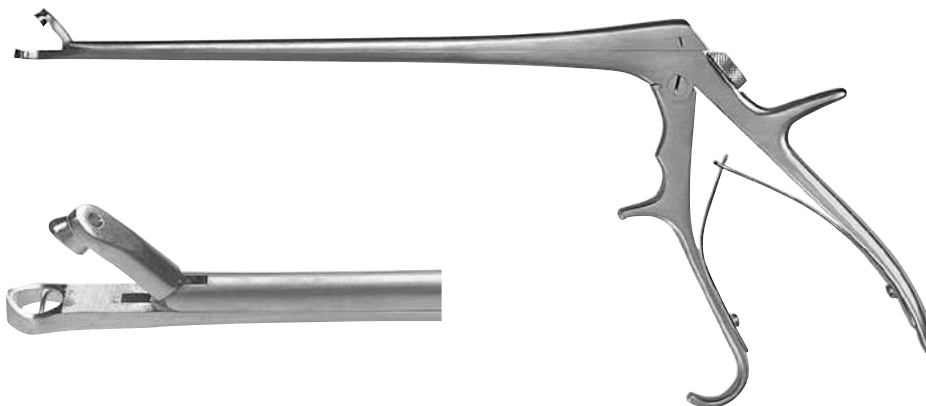

Burke

030-560-210 21,0 cm / 8¹/₄ 7x5 mm



030-572-000
Griff allein
handle only
manico solo
mango suelto

Aufsätze allein
Tips only
Puntas sueltas
Punti solo

030-570-001 Fig.1
030-570-003 Fig.3
030-570-004 Fig.4
030-570-005 Fig.5
komplett
complete
completo
completo



Tischler morgan
030-571-001 Fig.1



Townsend
030-571-003 Fig.3

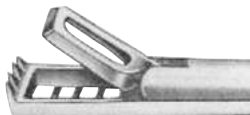

Kevorkian
030-571-004 Fig.4



**Mini-townsend
(baby-tischler)**
030-571-005 Fig.5

Probeexzisionszangen, IUP-Fasszangen
Uterine Biopsy Forceps, IUP Grasping Forceps
Pinze para biopsia, Pinzas para coger intra-uterinos
Pinze per biopsia, Pinze intra-uterine



flexibler Schaft
flexible shaft
vastago flexible
asta flessibile

Serpentine

030-580-220 22,0 cm / 8³/₄"
030-580-285 28,5 cm / 11¹/₄"



Schumacher

030-586-001
Aufsatz allein
Tip only
Punta suelta
Punta, sola

Schumacher

030-586-000 25,0 cm / 9³/₄"
komplett
complete
completo
completo



instrument
Superior Quality, Trusted Precision

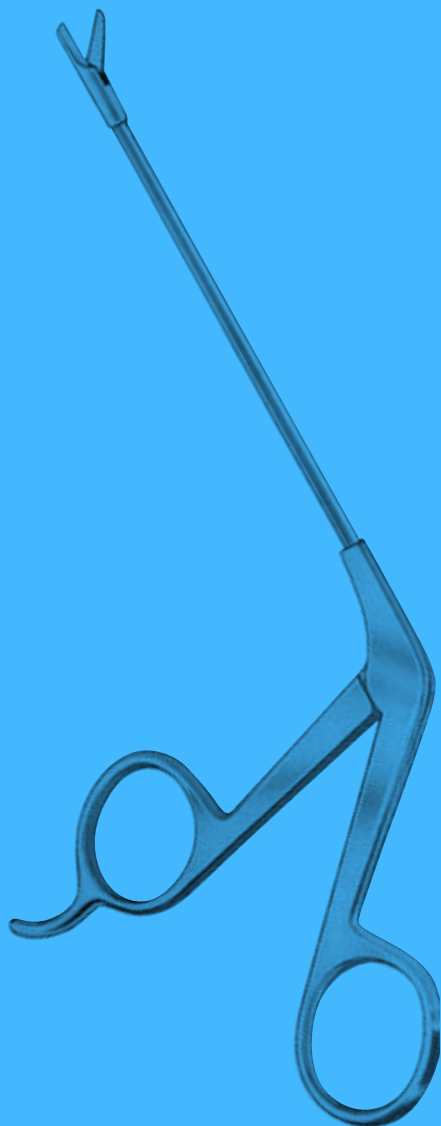

Rhinologie

Rhinology

Rinología

Rinologia

Septumzangen, scharfe Nasenzangen
Septum Forceps, Nasal Cutting Forceps
 Pinzas para tabique nasal, Pinzas nasales cortantes
 Pinze per il setto nasale, Pinze nasale taglianti per il naso

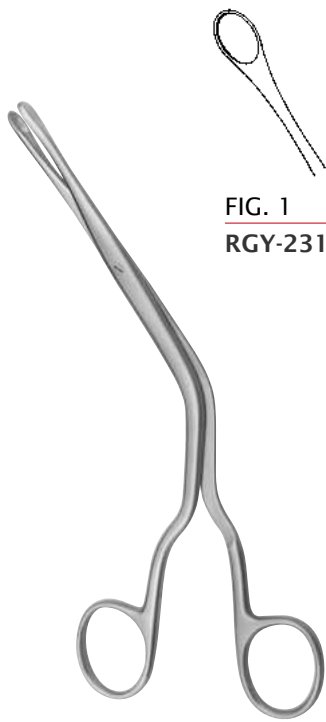

FIG. 1
 RGY-231-001



FIG. 2
 RGY-231-002

LUC
 RGY-231-001 - RGY-231-002 20,0 cm / 8"

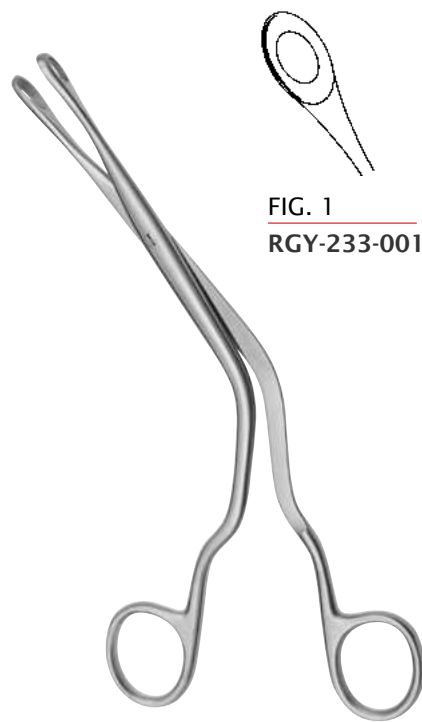

FIG. 1
 RGY-233-001



FIG. 2
 RGY-233-002

LUC
 RGY-233-001 - RGY-233-002 19,0 cm / 7½"

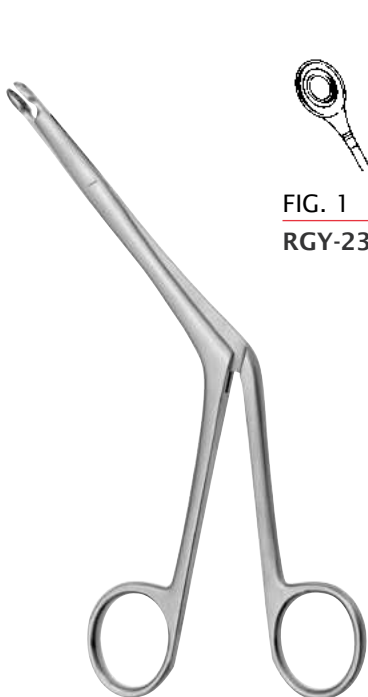

FIG. 1
 RGY-235-001



FIG. 2
 RGY-235-002

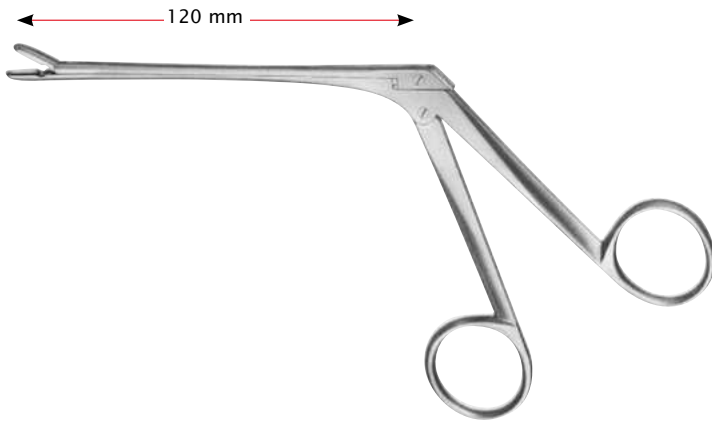

FIG. 3
 RGY-235-003



FIG. 4
 RGY-235-004

Bruenings
 RGY-235-001 - RGY-235-004 19,0 cm / 7½"



Takahashi

RGY-240-190 - RGY-241-190 19,0 cm / 7 1/2"

3 x 8 mm



RGY-240-190

gerade
straight
recto
retto

3 x 8 mm



RGY-241-190

aufgebogen
bent upwards
curva por arriba
curva in alto

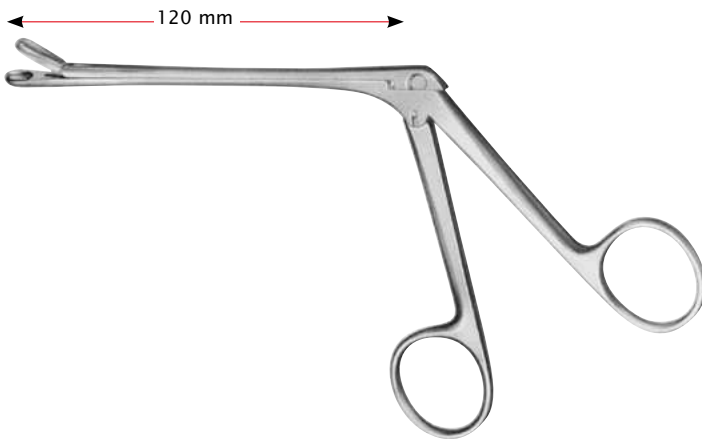

Watson-williams

RGY-243-190

gerade
straight
recto
retto

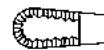

RGY-245-190

gerade
straight
recto
retto

RGY-243-190 - RGY-245-190 19,0 cm / 7 1/2"

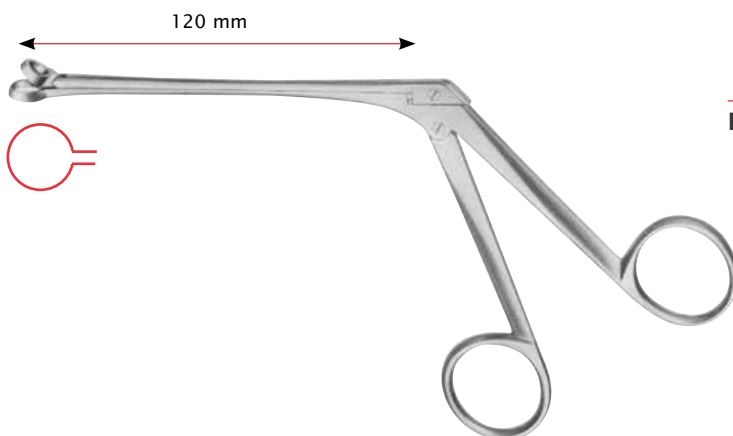

Hartmann

RGY-251-005 - RGY-251-011 19,0 cm / 7 1/2"



RGY-251-005 Ø 5 mm



RGY-251-007 Ø 7 mm



RGY-251-009 Ø 9 mm



RGY-251-011 Ø 11 mm



Schmeden

RGY-253-190 19,0 cm / 7 1/2"

Maulbreite 8,0 mm
jaw width 8,0 mm
anchura de la boca 8,0 mm
larghezza della bocca 8,0 mm

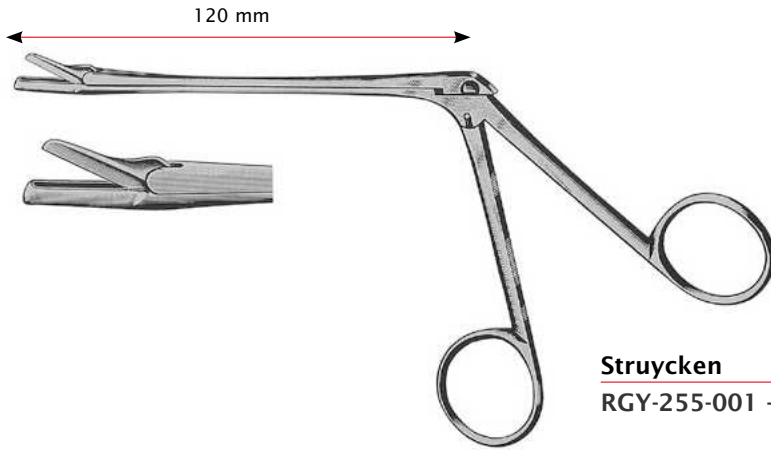

Struycken

RGY-255-001 - RGY-255-002 19,0 cm / 7¹/₂"

FIG. 1

RGY-255-001

Maulbreite 1,0 mm

jaw width 1,0 mm

anchura de la boca 1,0 mm

larghezza della bocca 1,0 mm

FIG. 2

RGY-255-002

Maulbreite 1,5 mm

jaw width 1,5 mm

anchura de la boca 1,5 mm

larghezza della bocca 1,5 mm

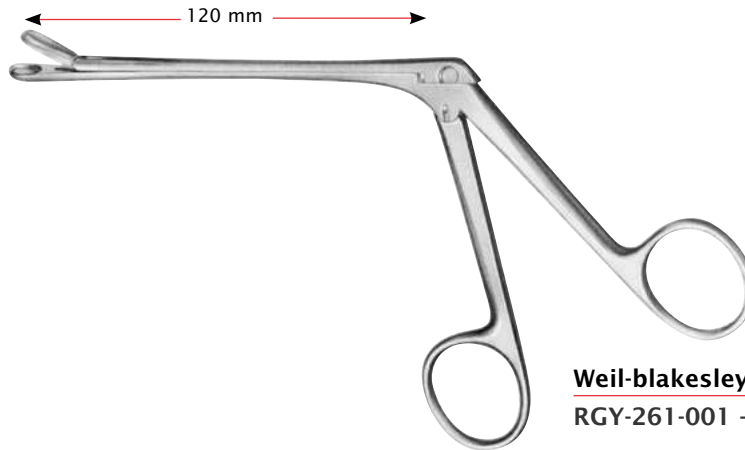

Weil-blakesley

RGY-261-001 - RGY-262-005 19,0 cm / 7¹/₂"



FIG. 1

RGY-261-001

Maulbreite 3,0 mm

jaw width 3,0 mm

anchura de la boca 3,0 mm

larghezza della bocca 3,0 mm

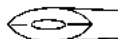

FIG. 2

RGY-261-002

Maulbreite 3,5 mm

jaw width 3,5 mm

anchura de la boca 3,5 mm

larghezza della bocca 3,5 mm



FIG. 3

RGY-261-003

Maulbreite 4,5 mm

jaw width 4,5 mm

anchura de la boca 4,5 mm

larghezza della bocca 4,5 mm

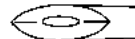

FIG. 4

RGY-261-004

Maulbreite 5,0 mm

jaw width 5,0 mm

anchura de la boca 5,0 mm

larghezza della bocca 5,0 mm



FIG. 5

RGY-261-005

Maulbreite 5,5 mm

jaw width 5,5 mm

anchura de la boca 5,5 mm

larghezza della bocca 5,5 mm



mit Hals
 with neck
 con cuello
 con collo

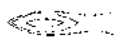

FIG. 1

RGY-262-001

Maulbreite 3,0 mm

jaw width 3,0 mm

anchura de la boca 3,0 mm

larghezza della bocca 3,0 mm



FIG. 2

RGY-262-002

Maulbreite 3,5 mm

jaw width 3,5 mm

anchura de la boca 3,5 mm

larghezza della bocca 3,5 mm



FIG. 3

RGY-262-003

Maulbreite 4,5 mm

jaw width 4,5 mm

anchura de la boca 4,5 mm

larghezza della bocca 4,5 mm



FIG. 4

RGY-262-004

Maulbreite 5,0 mm

jaw width 5,0 mm

anchura de la boca 5,0 mm

larghezza della bocca 5,0 mm

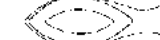

FIG. 5

RGY-262-005

Maulbreite 5,5 mm

jaw width 5,5 mm

anchura de la boca 5,5 mm

larghezza della bocca 5,5 mm

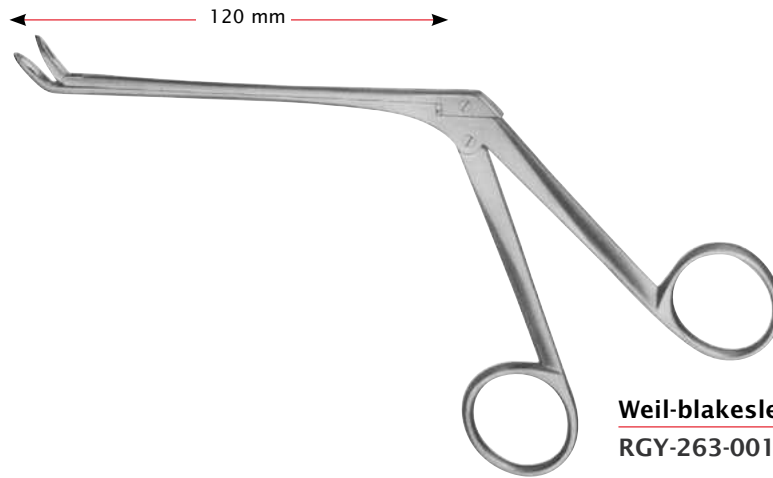

Weil-blakesley

RGY-263-001 - RGY-263-004 19,0 cm / 7 1/2"

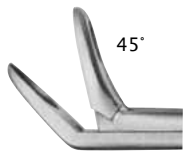

FIG. 1

RGY-263-001
Maulbreite 3,0 mm
jaw width 3,0 mm
anchura de la boca 3,0 mm
larghezza della bocca 3,0 mm

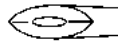

FIG. 2

RGY-263-002
Maulbreite 3,5 mm
jaw width 3,5 mm
anchura de la boca 3,5 mm
larghezza della bocca 3,5 mm



FIG. 3

RGY-263-003
Maulbreite 4,5 mm
jaw width 4,5 mm
anchura de la boca 4,5 mm
larghezza della bocca 4,5 mm



FIG. 4

RGY-263-004
Maulbreite 5,0 mm
jaw width 5,0 mm
anchura de la boca 5,0 mm
larghezza della bocca 5,0 mm

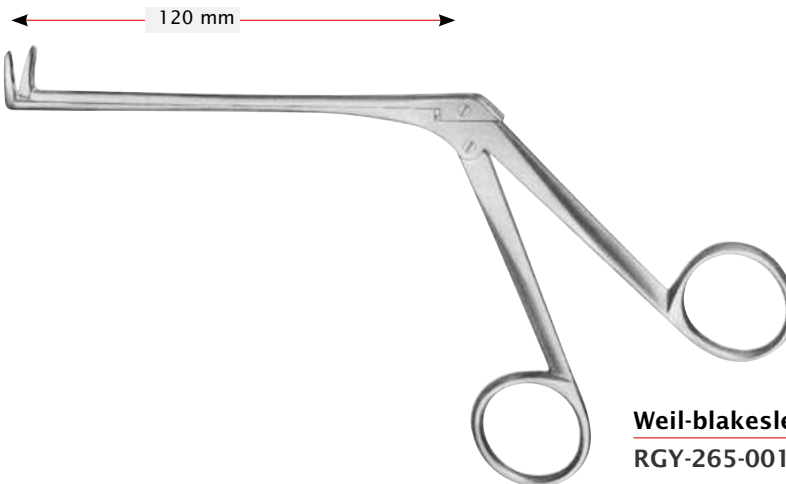

Weil-blakesley

RGY-265-001 - RGY-265-004 19,0 cm / 7 1/2"

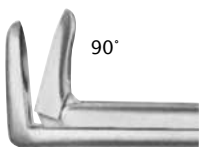

FIG. 1

RGY-265-001
Maulbreite 3,0 mm
jaw width 3,0 mm
anchura de la boca 3,0 mm
larghezza della bocca 3,0 mm

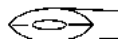

FIG. 2

RGY-265-002
Maulbreite 3,5 mm
jaw width 3,5 mm
anchura de la boca 3,5 mm
larghezza della bocca 3,5 mm

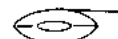

FIG. 3

RGY-265-003
Maulbreite 4,5 mm
jaw width 4,5 mm
anchura de la boca 4,5 mm
larghezza della bocca 4,5 mm

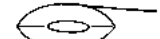
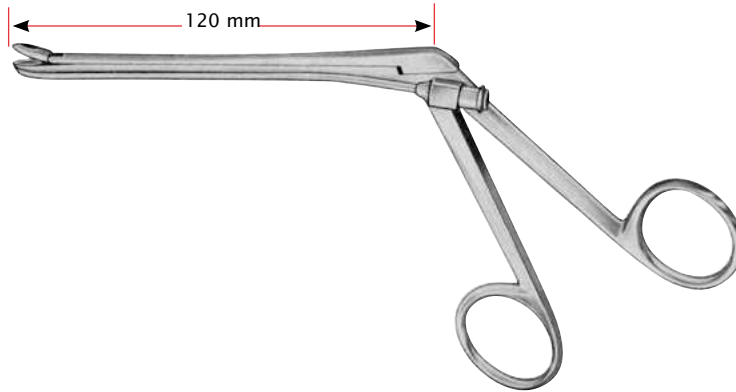

FIG. 4

RGY-265-004
Maulbreite 5,0 mm
jaw width 5,0 mm
anchura de la boca 5,0 mm
larghezza della bocca 5,0 mm



Weil-blakesley

RGY-271-001 - RGY-279-003 19,0 cm / 7 1/2"

gerade
straight
 recta
 retta



RGY-271-001 2,5 mm



RGY-271-002 3,6 mm



RGY-271-003 4,8 mm

45° aufgebogen
45° up curved
 45° curva arriba
 45° curva in alto



RGY-273-001 2,5 mm

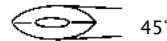

RGY-273-002 3,6 mm



RGY-273-003 4,8 mm

90° aufgebogen
90° up curved
 90° curva arriba
 90° curva in alto



RGY-275-001 2,5 mm



RGY-275-002 3,6 mm

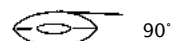

RGY-275-003 4,8 mm

rechts gebogen
right curved
 curva por derecha
 curva a destra



RGY-277-001 2,5 mm



RGY-277-002 3,6 mm

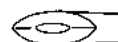

RGY-277-003 4,8 mm

links gebogen
left curved
 curva por izquierda
 curva a sinistra



RGY-279-001 2,5 mm

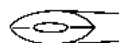

RGY-279-002 3,6 mm

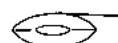

RGY-279-003 4,8 mm

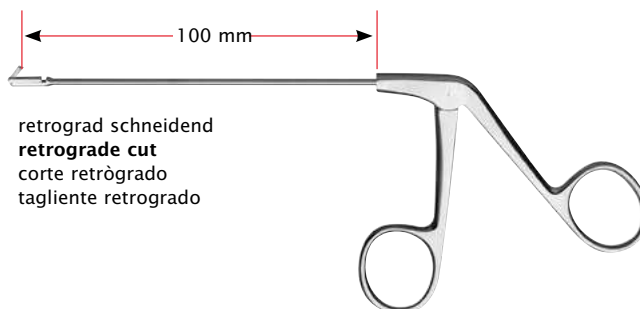

retrograd schneidend
retrograde cut
corte retrògrado
tagliante retrogrado

Stammburger

RGY-291-001 - RGY-291-003

Antrumstanze
Antrum Punch
Pinza saca-bocado para seno maxilar
Pinza tagliante per seno mascellare



RGY-291-001 2 mm
oben schneidend
up cutting
cortante por arriba
tagliante in alto



RGY-291-002 2 mm
rechts schneidend
right cutting
cortante a la derecha
tagliante a destra



RGY-291-003 2 mm
links schneidend
left cutting
cortante a la izquierda
tagliante a sinistra

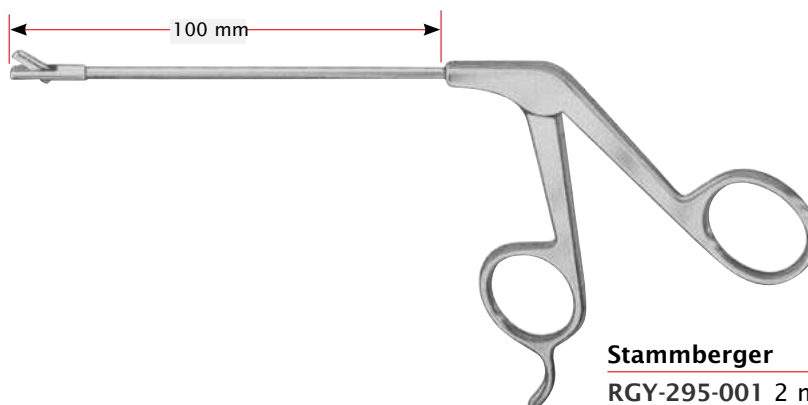

Stammburger

RGY-295-001 2 mm

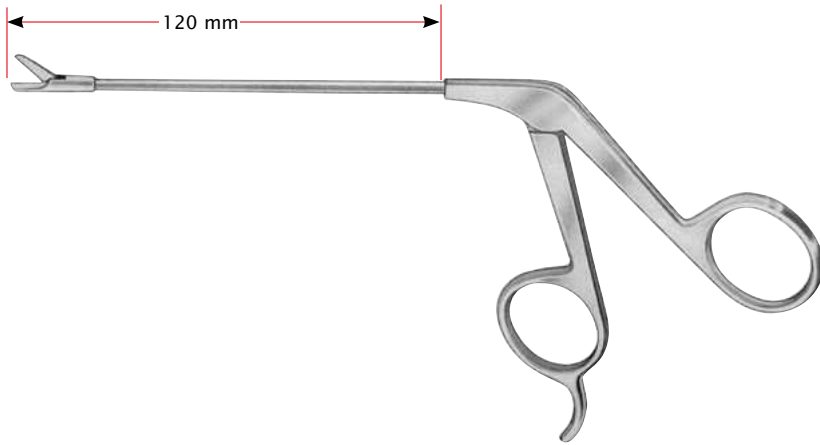

RGY-301-001 - RGY-301-003



RGY-301-001 Ø 5 mm

gerade schneidend
straight cutting
 cortante recto
 tagliente retto

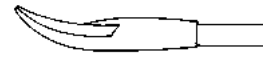

RGY-301-002 Ø 5 mm

rechts gebogen schneidend
right curved cutting
 cortante curva derecha
 tagliente curva destra

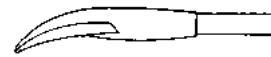

RGY-301-003 Ø 5 mm

links gebogen schneidend
left curved cutting
 cortante curva izquierda
 tagliente curva sinistra

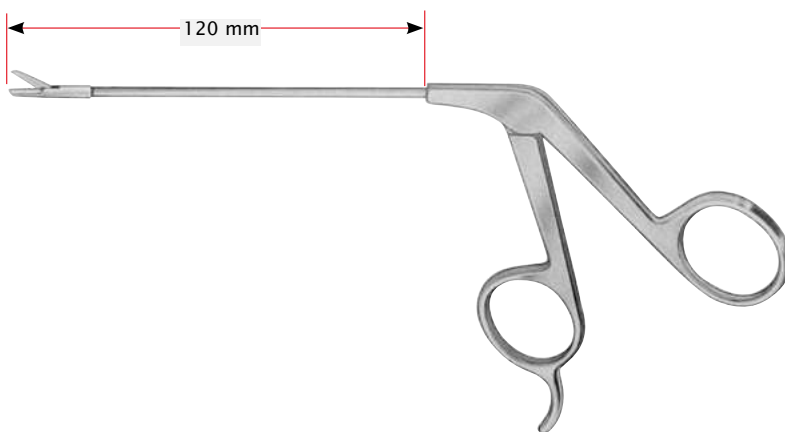

RGY-305-001 - RGY-305-003



RGY-305-001 Ø 3,5 mm

gerade schneidend
straight cutting
 cortante recto
 tagliente retto



RGY-305-002 Ø 3,5 mm

rechts gebogen schneidend
right curved cutting
 cortante curva derecha
 tagliente curva destra



RGY-305-003 Ø 3,5 mm

links gebogen schneidend
left curved cutting
 cortante curva izquierda
 tagliente curva sinistra

140 mm



RGY-340-040

oben schneidend
up cutting
cortante por arriba
tagliente in alto

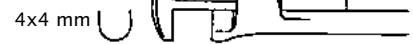

RGY-342-040

unten schneidend
down cutting
cortante por abajo
tagliente in basso

Hajek

RGY-340-040 - RGY-342-040 14,0 cm / 5 1/2"

140 mm



RGY-344-035

oben schneidend
up cutting
cortante por arriba
tagliente in alto



RGY-346-035

unten schneidend
down cutting
cortante por abajo
tagliente in basso

Hajek-kofler

RGY-344-035 - RGY-346-035 14,0 cm / 5 1/2"

Antrumstanzen, Keilbeinstanzen

Antrum Punches, Sphenoid Bone Punches

Pinzas sacabocadas para seno maxilar, Pinzas sacabocadas para esfenoides

Pinze taglienti per seno mascellare, Pinze taglienti per seno sfenoidale



3x3 mm



RGY-350-033

oben schneidend
up cutting
cortante por arriba
tagliente in alto

4x4 mm



RGY-350-044

oben schneidend
up cutting
cortante por arriba
tagliente in alto

5x5 mm



RGY-350-055

oben schneidend
up cutting
cortante por arriba
tagliente in alto

6x6 mm



RGY-350-066

oben schneidend
up cutting
cortante por arriba
tagliente in alto

Kerrison

RGY-350-033 - RGY-350-066 17,0 cm / 6 ³/₄"



OTO-450-015 1,5 mm



OTO-450-020 2,0 mm



OTO-450-030 3,0 mm

Citelli

OTO-450-015 - OTO-450-030 17,0 cm / 6 ³/₄"



instrument

Superior Quality, Trusted Precision

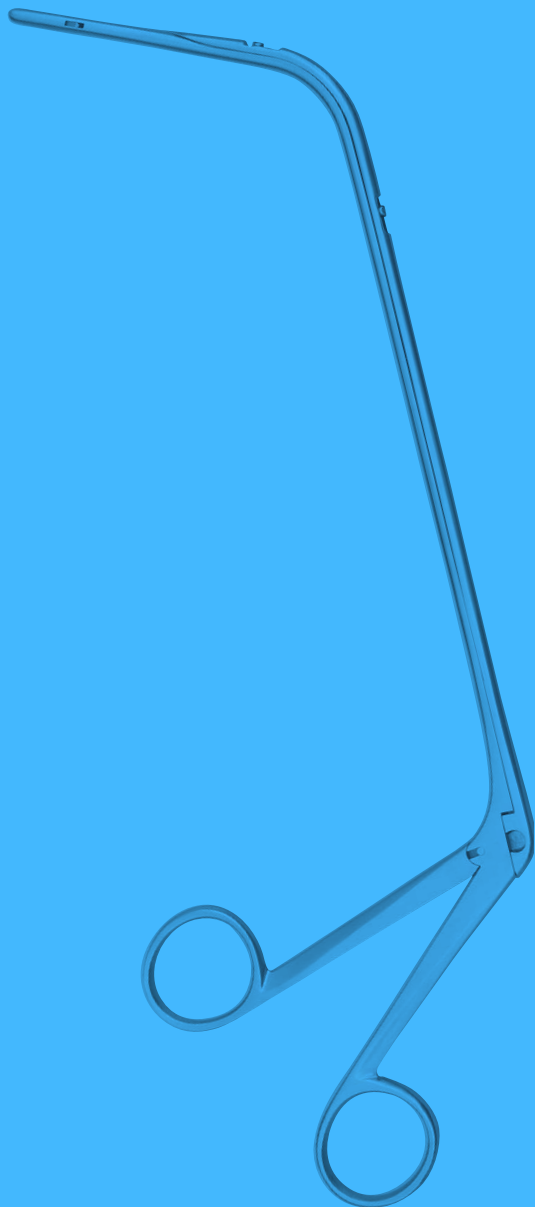

Mund-, kiefer- und gesichtschirurgie

Oral maxillo-facial surgery

Cirugía oral y maxilofacial

Chirurgia maxillo-facciale

Tonsillenzange
Tonsil punches
Pinzas para amígdalas
Pinze per tonsille



Hartmann

OMS-435-013 - OMS-435-017



OMS-435-013 Ø 13 mm

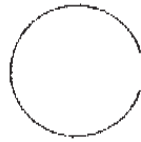

OMS-435-015 Ø 15 mm

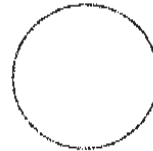

OMS-435-017 Ø 17 mm



Chevalier-jackson
OMS-440-300 - OMS-446-600



Fig. 1
OMS-440-300 30,0 cm
OMS-440-400 40,0 cm
OMS-440-500 50,0 cm
OMS-440-600 60,0 cm



Fig. 2
OMS-441-300 30,0 cm
OMS-441-400 40,0 cm
OMS-441-500 50,0 cm
OMS-441-600 60,0 cm



Fig. 3
OMS-442-300 30,0 cm
OMS-442-400 40,0 cm
OMS-442-500 50,0 cm
OMS-442-600 60,0 cm



Fig. 4
OMS-443-300 30,0 cm
OMS-443-400 40,0 cm
OMS-443-500 50,0 cm
OMS-443-600 60,0 cm



Fig. 5
OMS-444-300 30,0 cm
OMS-444-400 40,0 cm
OMS-444-500 50,0 cm
OMS-444-600 60,0 cm



Fig. 6
OMS-445-300 30,0 cm
OMS-445-400 40,0 cm
OMS-445-500 50,0 cm
OMS-445-600 60,0 cm



Fig. 7
OMS-446-300 30,0 cm
OMS-446-400 40,0 cm
OMS-446-500 50,0 cm
OMS-446-600 60,0 cm



Huber
OMS-450-001
Universal-Griff
Universal Handle
Mango universal
Manico universale



Bruenings
OMS-452-200 20,0 cm / 8"
OMS-452-300 30,0 cm / 12"
OMS-452-400 40,0 cm / 16"

Verlängerungsrohr für Handgriff Art.-Nr. OMS-450-001
interchangeable Tube for handle ref. OMS-450-001
Tubo de extensión para mango ref. OMS-450-001
Tube allunghi per manico rif..OMS-450-001

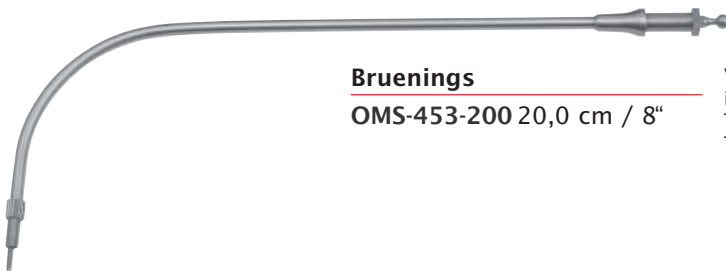

Bruenings
OMS-453-200 20,0 cm / 8"

Verlängerungsrohr gebogen für Handgriff Art.-Nr. OMS-450-001
interchangeable Tube, curved for handle ref. OMS-450-001
Tubo de extensión, curva para mango ref. OMS-450-001
Tube allunghi, curva per manico rif..OMS-450-001



Fraenkel
 OMS-456-001



Seiffert
 OMS-458-001



Fraenkel
 OMS-460-001



Scheinmann
 OMS-461-001



Scheinmann
 OMS-463-001



Bruenings
 OMS-464-003
 OMS-464-004



Bruenings
 OMS-466-002
 OMS-466-003



Lange
 OMS-468-001



Krause
 OMS-470-001
 OMS-470-002



Krause
 OMS-472-001



Cordes
 OMS-474-001
 OMS-474-002
 OMS-474-003
 OMS-474-004



Schumacher
 OMS-476-001



Cordes
 OMS-478-001
 OMS-478-002



Cordes
 OMS-480-001



Rosenberg
 OMS-482-001



OMS-485-001

nach rechts öffnend
opening to right
side
abriendo hacia la derecha
aprente verso
destra



OMS-485-002

nach links öffnend
opening to left side
abriendo hacia la izquierda
aprente verso sinistra



OMS-485-003

nach unten öffnend
opening down-ward
abriendo hacia abajo
aprente in basso

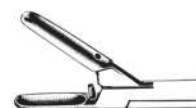

OMS-485-004

nach oben öffnend
opening up-ward
abriendo hacia arriba
aprente in alto

Jurasz

OMS-485-001 - OMS-485-004 23,0 cm / 9"



Reichert

OMS-487-240 24,0 cm / 9½"

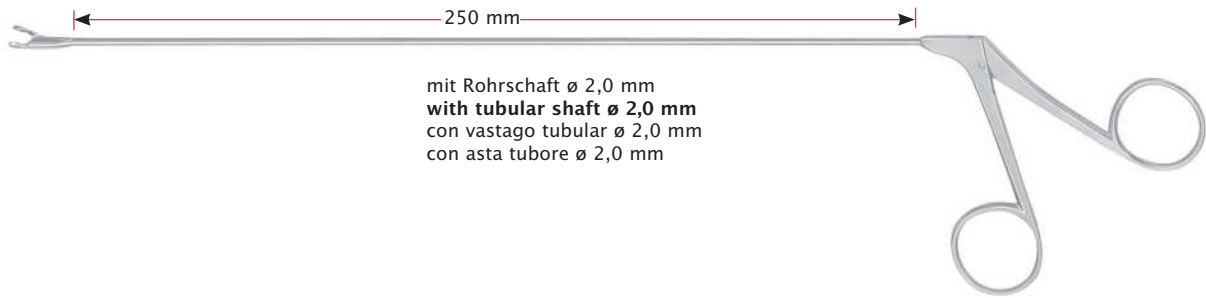

mit Rohrschaft \varnothing 2,0 mm
with tubular shaft \varnothing 2,0 mm
 con vastago tubular \varnothing 2,0 mm
 con asta tubore \varnothing 2,0 mm

OMS-490-001 - OMS-494-004



gerade
straight
 recta
 retta

OMS-490-001

Löffel rund \varnothing 2,5 mm
round cup \varnothing 2,5 mm
 Cuchara redonda \varnothing 2,5 mm
 Cucchiaino rotondo \varnothing 2,5 mm



links gebogen
curved left
 curva izquierda
 curva sinistra

OMS-490-002

Löffel rund \varnothing 2,5 mm
round cup \varnothing 2,5 mm
 Cuchara redonda \varnothing 2,5 mm
 Cucchiaino rotondo \varnothing 2,5 mm



rechts gebogen
curved right
 curva derecha
 curva destra

OMS-490-003

Löffel rund \varnothing 2,5 mm
round cup \varnothing 2,5 mm
 Cuchara redonda \varnothing 2,5 mm
 Cucchiaino rotondo \varnothing 2,5 mm



aufgebogen
angled upward
 curva hacia arriba
 curva in alto

OMS-490-004

Löffel rund \varnothing 2,5 mm
round cup \varnothing 2,5 mm
 Cuchara redonda \varnothing 2,5 mm
 Cucchiaino rotondo \varnothing 2,5 mm



gerade
straight
 recta
 retta

OMS-492-001



links gebogen
curved left
 curva izquierda
 curva sinistra

OMS-492-002



rechts gebogen
curved right
 curva derecha
 curva destra

OMS-492-003



gerade
straight
 recta
 retta

OMS-494-001



links gebogen
curved left
 curva izquierda
 curva sinistra

OMS-494-002



rechts gebogen
curved right
 curva derecha
 curva destra

OMS-494-003



aufgebogen
angled upward
 curva hacia arriba
 curva in alto

OMS-494-004

CONTACT

WEBSITE: WWW.ZSINSTRUMENT.COM

EMAIL: INFO@ZSINSTRUMENT.COM

PH: 92 3480197097

ADDRESS: S.I.E SIALKOT PAKISTAN 51310